



Human-Computer Interaction IS 4300

Prof. Timothy Bickmore



Overview for Today

- Overview of the Course
- Logistics
- Overview of HCI
- Some basic concepts
- Overview of Team Projects
- Introductions





 **Overview of Course**

ccs.neu.edu/course/is4300f15/

Course Website

IS4300– Human-Computer Interaction

[\[Syllabus\]](#) [\[Schedule\]](#) [\[Homework\]](#) [\[Projects\]](#) [\[Resources\]](#) [\[Directory\]](#)

Schedule

Date	Topics & Readings	Assignments	
		Due	Start
9/9	Overview of HCI and course. Getting started on projects.		I1 , P1
9/14	HCI development process (Benyon Ch 1 & 3). Critical Analysis of UIs (Benyon 4.5 & 10.2). Team project brainstorming.	I1	I2
9/16	Humans (Benyon Ch 21 & 25). Team project brainstorming.		
9/21	Doing observational studies (Benyon Ch 2 & 7; Fetterman ; Example 1 ; Example 2).	I2	I3



Overview of Course

- Topics covered
 - HCI Practice
 - HCI Programming
 - ... and a little theory & research

- Prerequisites
 - Official: CS 3500 Object-Oriented Design
 - Java basics (you must be proficient in 3 weeks)

Overview of Course

■ Texts

- Req'd: Benyon, *Designing Interactive Systems, 3rd ed*
- Opt: Nielsen, *Usability Engineering (\$11 digital)*
- Opt: Rosson & Carroll, *Usability Engineering: Scenario-Based Development of Human-Computer Interaction*

THIRD EDITION
Designing Interactive
Systems
A comprehensive guide to HCI, UX and interaction design

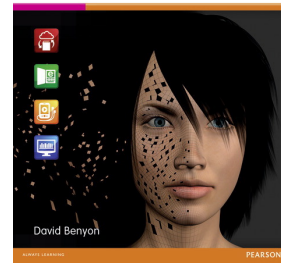

Overview of Course

- Weekly Requirements
 - Read ~50 pages
 - Individual homework assignment
 - Project assignment
 - In-class Quiz
 - Describe and discuss assignments in class



Typical Class

1. Occasional Quiz
2. Review assignments. Presentation and discussion by randomly selected students.
3. Lecture on HCI practice topic.
4. In class exercise
5. Discussion of next assignments.



Quizzes

- Quizzes
 - Check understanding and ramifications of readings.
 - Usually 1-2 questions directly from readings, possibly applying the material to a new problem.
 - “Describe the Squishy Interface.”
 - “Describe two usability metrics appropriate for a new xbox game.”
 - “Give an example of inter-application consistency.”



Administrivia

- Tim
 - 911-177 (177 Huntington),
is4300f15@ccs.neu.edu
 - Office hours: Tues 12-1:30 (tentative, starting 9/22), after class, or by appointment
 - Send me an email if you are coming!
- TAs – Dina Utami & Kathleen Mullins
 - dinau@ccs.neu.edu
- Class: is4300f15-all@ccs.neu.edu



Schedule Based on Team Project

- P1 – Find a Project (2.5 weeks)
- P2 – Requirements Analysis (1 week)
- P3 – Conceptual Design (1.5 weeks)
- P4 – Design Sketches (1 week)
- P5 – Paper Prototyping (1.5 weeks)
- P6 – Computer Prototyping (2.5 weeks)
- P7 – Heuristic Evaluation & Prototype Revision #1 (1.5 wks)
- P8 – User Testing & Prototype Revision #2 (1.5 weeks)
- P9 - Final Presentation and Report



Grading

- Team project (30%, comprised of 10% for each of P1-P8, 20% for T9)
- Individual homework (25% divided equally among graded assignments)
- Final Exam (25%)
- Quizzes (10%)
- Class participation (10%)



Overview of HCI

- What is HCI?
- Motivation for HCI
- Some basic concepts

What is HCI?

ACM SIGCHI Curricula for HCI

- Human-computer interaction is a discipline concerned with the **design, evaluation and implementation** of interactive computing systems for **human use** and with the study of major phenomena surrounding them.

What is HCI?



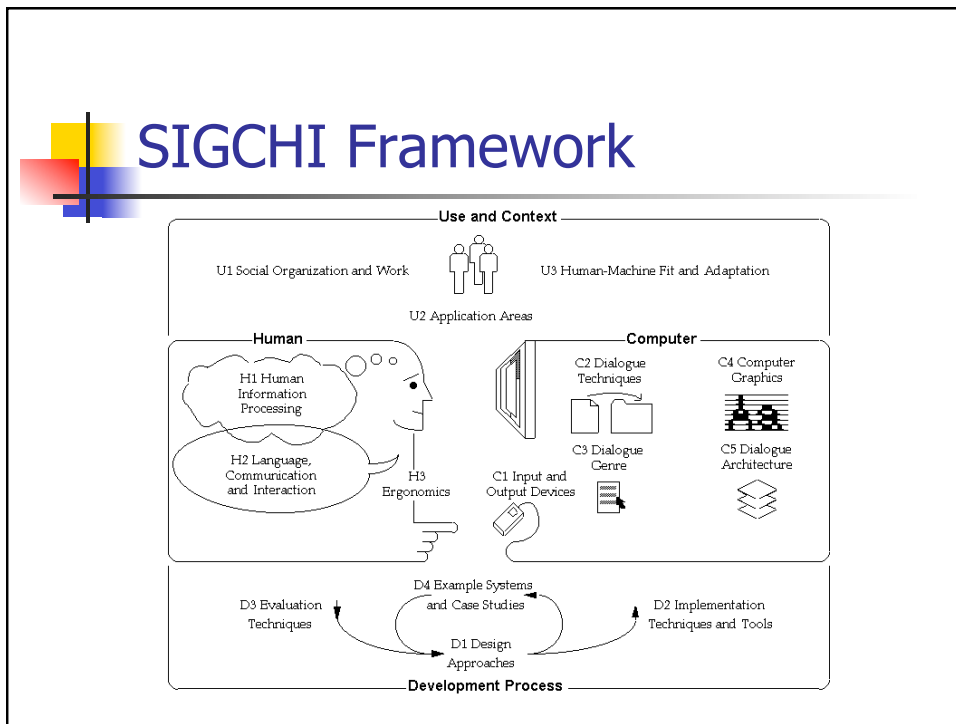

What is HCI?

extensional definition

- GUIs & toolkits
- Mobile computing
- Conversational interfaces
- Collaborative & Social interfaces
- Multimodal interfaces
- ...



What do UI professionals do?

- **interaction designers** – (IxD) people involved in the design of all the interactive aspects of a software product
- **user experience designers (UX)** – extends IxD with all aspects of user experience, including hardware, manual, etc.
- **web designers**
- **mobile app designers**
- **usability engineers** - people who focus on evaluating products, using usability methods and principles



Why Study HCI?



HCI is Important

from Nielsen – Usability Engineering

- Redesign of rotary dial telephone speeded up users' dialing behavior by 0.15 sec/digit, saving \$1M in reduced demand on central switches.
- Redesign insurance forms to reduce customer errors: cost Aus\$100,000; savings Aus \$500,000/year.
- Redesign of Boeing 757 flight deck interface to reduce flight crew from 3 to 2



HCI is Important

from Nielsen – Usability Engineering

- Study of software engineering costs
 - 63% significantly overran budgets
 - 4 reasons rated with highest responsibility:
 - Frequent change requests by users
 - Overlooked tasks
 - Users' lack of understanding of their own req'ts
 - Insufficient user-analyst communication & understanding

*Lederer & Prasad, CACM '92
115 surveys of projects >=\$50K*

HCI is Important

- UI strongly affects perception of software
 - Usable software sells better
 - "Ease of use" ratings
- For many shrink-wrapped products a single call to customer support can wipe out profits



HCI is Important

FDA Center for Devices and Radiological Health report

- Many deaths and injuries attributable to poor human interface (hardware & software) design.
 - oxygen flow control knob, smooth rotation but with discrete settings and no flow at intermediates



HCI is Important

JAMA. 2005;293:1197-1203

- Study of a hospital computerized physician order entry system (CPOE)
 - Identified 22 ways in which the system caused patients to get the wrong medicine, e.g.
 - fragmented displays that prevent a coherent view of patients' medications
 - pharmacy inventory displays mistaken for dosage guidelines
 - separation of functions that facilitate double dosing and incompatible orders



- **Three quarters of the house staff reported observing each of these error risks, indicating that they occur weekly or more often**

HCI is Important

Therac-25 Accidents

Therac-25
performed
both
radiation
treatment
and X-rays

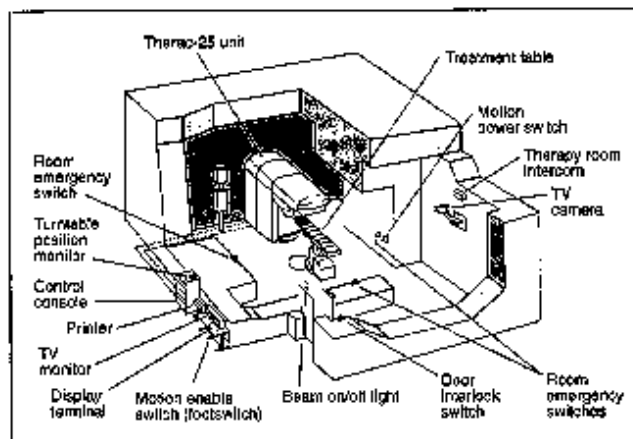

Figure 1. Typical Therac-25 facility.

HCI is Important

Therac-25 Accidents

```

PATIENT NAME : TEST                                A    1
TREATMENT MODE: FIX    BEAM TYPE: X ENERGY (KeV): 25

                                ACTUAL    PRESCRIBED
UNIT RATE/MINUTE                0          200
MONITOR UNITS                    50    50    200
TIME (MIN)                       0.27      1.00

GANTRY ROTATION (DEG)            0.0          0    VERIFIED
COLLIMATOR ROTATION (DEG)    359.2    359    VERIFIED
COLLIMATOR X (CM)              14.2    14.3    VERIFIED
COLLIMATOR Y (CM)              27.2    27.3    VERIFIED
WEDGE NUMBER                    1          1    VERIFIED
ACCESSORY NUMBER                0          0    VERIFIED

DATE : 84-OCT-26  SYSTEM: BEAM READY  OP.MODE: TREAT  AUTO
TIME : 12:55. 8   TREAT : TREAT PAUSE X-RAY        173777
OPR ID: T25V02-RO3 REASON: OPERATOR   COMMAND:

```

HCI is Important

Therac-25 Accidents

- Six accidents involving massive overdoses to patients occurred between 1985 and 1987
- Occasional machine malfunctions with little feedback, resulting in repeated dosages (6 in one case)
 - Displayed "MALFUNCTION" with an error code
 - Manual did not describe error codes
 - Result: operators just overrode error message
- Poor feedback about which mode the machine was in caused treatments with 125x the expected dose
- Several patients died as a result.

Why do work in HCI?

- Interdisciplinary work
- Interact with people, learn about them and their work
- Help people
- It's cool...

HCI is Cool!

Now ubiquitous examples...



HCI is Cool



HCI is Cool



HCI is Cool

User Study

We set up a user study with one finalised Tic-Tac-Toe game design.

3 pairs of interfaces were mapped on the game that creates 3 versions of the game.



All 3 versions were played in each round of tournament.

PS	T	T
PS	PS	T
PS	PS	T

Push / Touch

PL	PS	PL
PL	PL	PS
PS	PS	PS

Push/ Pull

PL	T	T
PL	PL	T
T	PL	T

Pull / Touch

HCI is Cool



HCI is Cool

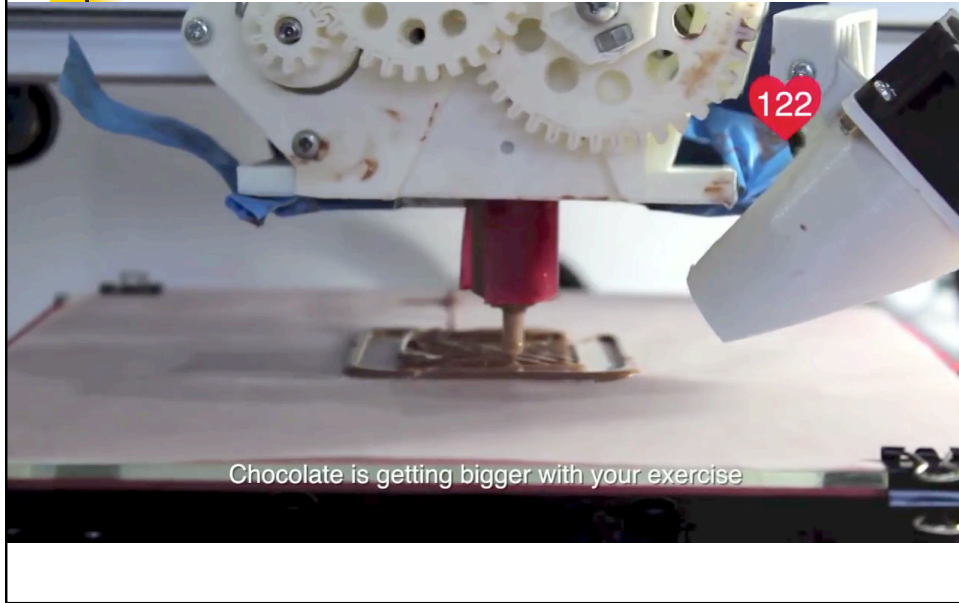

HCI is Cool

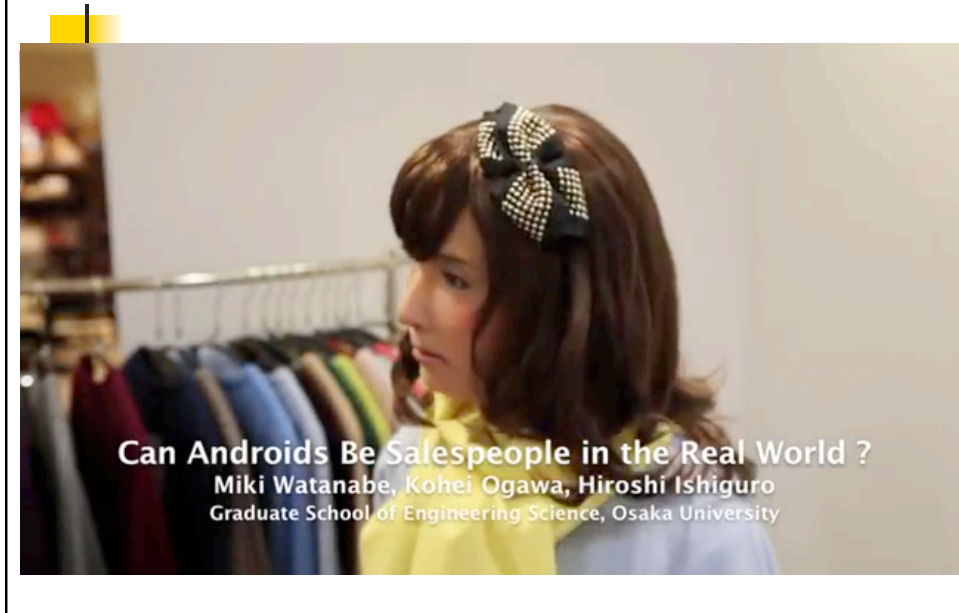



HCI is Cool

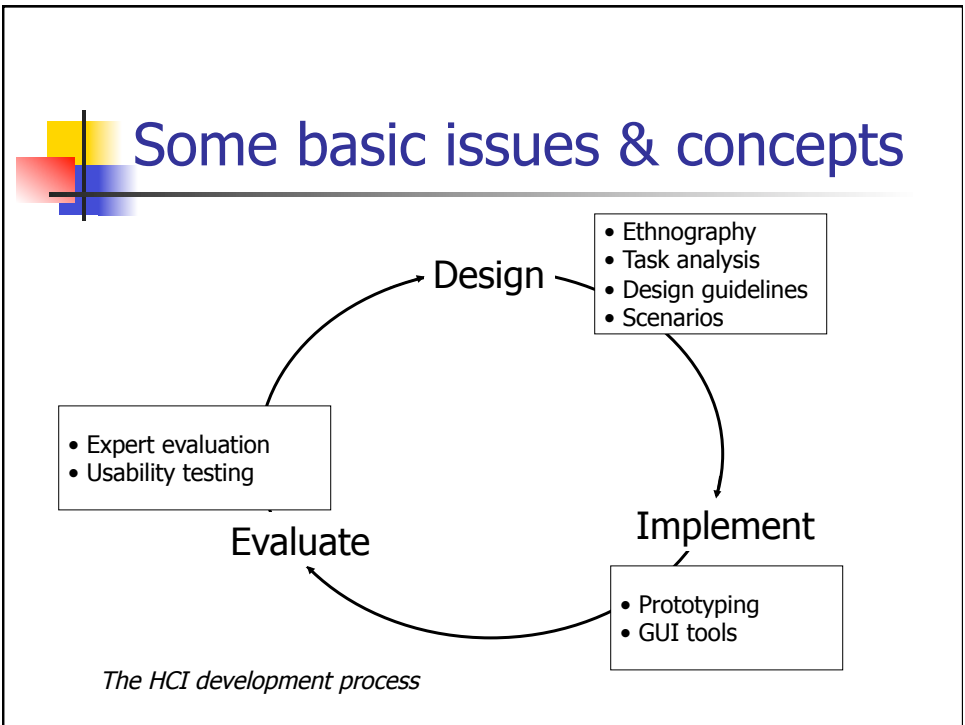
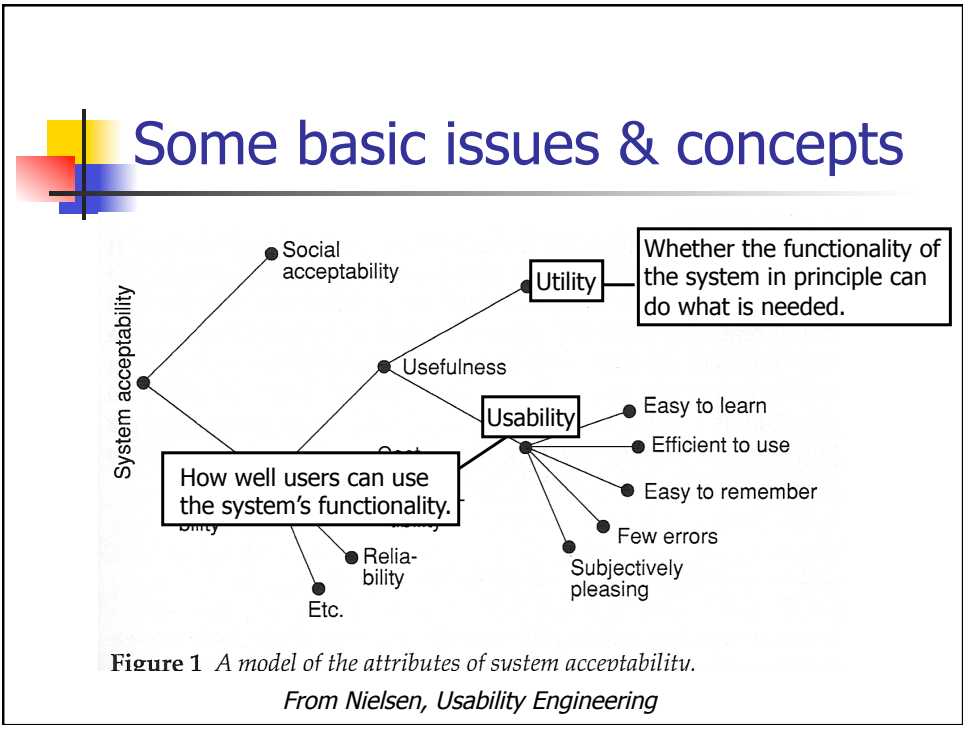

Some basic issues & concepts

- Building good UIs is hard
 - Many iterations
 - Much user interaction
 - Many kinds of expertise
 - 50% of the total lifecycle effort in modern software
 - *Survey of 74 projects, Myers & Rosson, CHI'92*





Semester Team Project

- 
- ## Project Guidelines
-
- Must have a substantial UI
 - UI must be interactive
 - Creative, original, non-obvious is better
 - Ideas: research papers & past CHI, UIST, IUI, CSCW
 - Each team must have 2-4 members
 - Ideally complementary skills
 - If you are having “issues” with your teammates, please talk to me!



Example Past Projects

- Advanced Directives for Geriatrics
- D&D Character Editor
- NU Course Finder
- NU Course Scheduler
- MBTA Alerts / Schedules
- Vocal Warm Up App
- Virtual Yoga Instructor



To Do for Next Class

- Read
 - HCI development process (Benyon Ch 1 & 3).
 - Critical Analysis of UIs (Benyon 4.5 & 10.2)
- Set up individual course web page (I1 – next class)
 - Email me URL
 - Next class: post 3 project ideas
- Start getting up to speed on Java basics.

- Project P1 (thinking about projects – 2.5 weeks)
- Review CHI Proceedings for inspiration.

- *Note: All assignments must be posted by noon before class on due date.*



Introductions

- Name
- Major
- Worst user interface you have ever used & why