

Regular Languages

Natural Language Processing
CS 4120/6120—Spring 2016
Northeastern University

David Smith
with material from Jason Eisner, Andrew McCallum,
and Lari Karttunen

Brief History: 1950s

- Early NLP on machines less powerful than pocket calculators
 - ❖ E.g., how to compress a word list into memory
- Foundational work on automata, formal languages, information theory
- First speech systems (Bell Labs)
- Machine translation heavily funded by military, basically just word substitution
- Little formalization of syntax, semantics, pragmatics

Brief History: 1960s

- ALPAC report (Alvey, 1966) ends funding for MT in U.S.
 - ❖ Lack of practical results, recommends basic research
- ELIZA and other early AI dialogue systems
 - ❖ Risibly easy Turing tests
- Early corpora: Brown Corpus (Kučera & Francis)

Brief History: 1970s

- Winograd's SHRDLU (1971): existence proof of NLP (in tangled Lisp code)
 - ❖ Interpreted language about "blocks world"
 - Which cube is sitting on the table?
 - *The large green one which supports the red pyramid.*
 - Is there a large block behind the pyramid?
 - *Yes, three of them. A large red one, a large green cube, and the blue one.*
 - Put a small one onto the green cube which supports a pyramid.
 - *OK.*
- Hidden Markov models for speech recognition

Brief History: 1980s

- Procedural → declarative
 - ❖ Grammars, logic programming
 - ❖ Separation of processing (parser) from description of linguistic knowledge
- Representations of meaning: procedural semantics (SHRDLU), semantic nets (Schank), logic (starting in 1970s, Montague, Partee)
- Knowledge representation (Lenat: Cyc, still going!)
- MT in limited domains (METEO)
- HMMs for part-of-speech tagging (independently, Church & DeRose)

Brief History: 1990s

- Probabilistic paradigm shift
 - ❖ Speech recognition methods take over the world
- IR-style evaluations take over the world
- Finite-state methods in speech and beyond
- Large amounts of monolingual and multilingual text become available, esp. on WWW
- Classification problems and *ambiguity resolution* (in syntax, lexical semantics, translation, etc.)

Brief History: Now

- Even more machine learning
 - ❖ Successful unsupervised systems
- Even more data, and tasks
- Widely usable—and used—speech recognition and machine translation
- Widely usable syntactic parsing
- Some usable dialog systems
- Convergence with IR, question answering, probabilistic knowledge representation

Noam Chomsky 1928–

Formal languages
(Chomsky hierarchy)

Generative grammar

Anarcho-Socialist

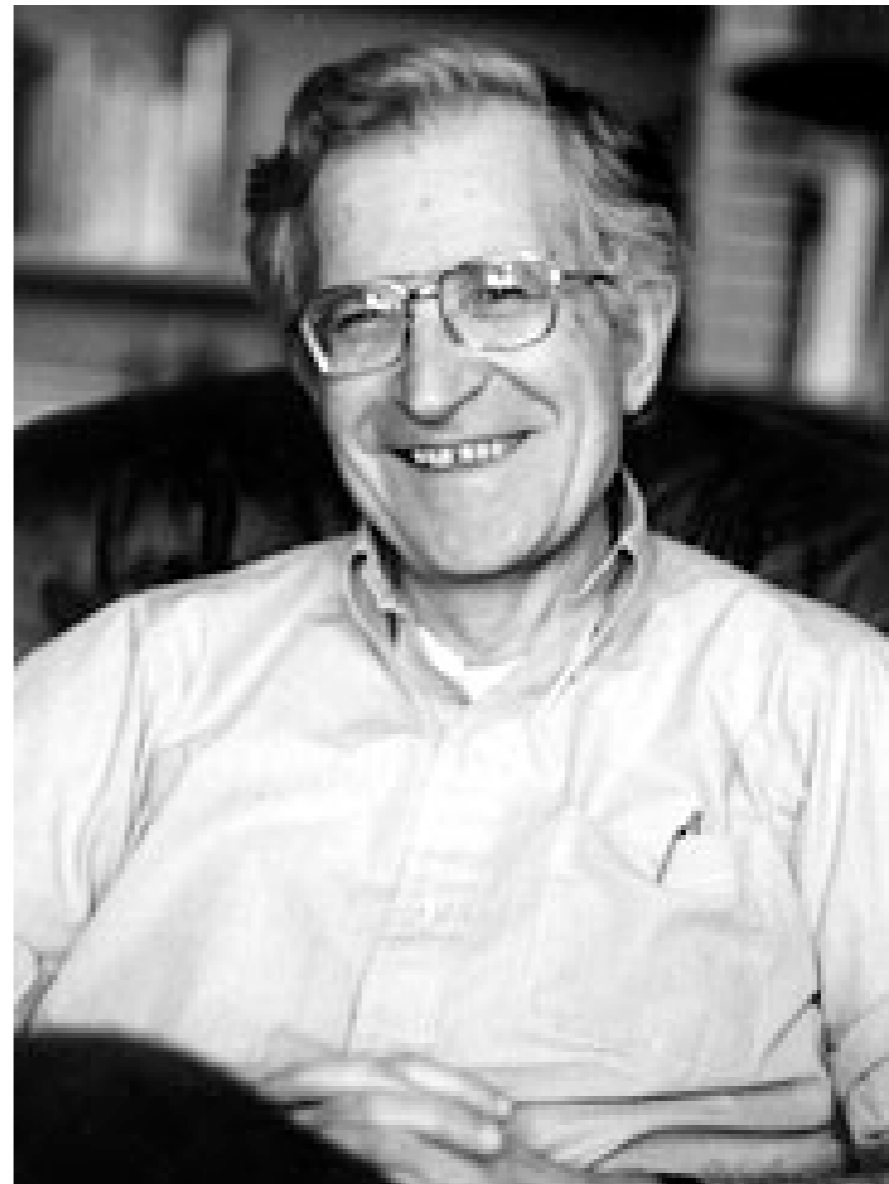

A Language

- Some sentences in the language
 - ❖ The man took the book.
 - ❖ Colorless green ideas sleep furiously.
 - ❖ This sentence is false.
- Some sentences not in the language
 - ❖ *The girl, the sidewalk, the chalk, drew.
 - ❖ *Backwards is sentence this.
 - ❖ *Je parle anglais.

Languages as Rewriting Systems

- Start with some “non-terminal” symbol S
- Expand that symbol, using a **rewrite rule**.
- Keep applying rules until all non-terminals are expanded to terminals.
- The string of terminals is a sentence of the language.

Chomsky Hierarchy

- Let Caps = nonterminals; lower = terminals; Greek = strings of terms/nonterms
- Recursively enumerable (Turing equivalent)
 - ✦ Rules: $\alpha \rightarrow \beta$
- Context-sensitive
 - ✦ Rules: $\alpha A \beta \rightarrow \alpha \gamma \beta$
- Context-free
 - ✦ Rules: $A \rightarrow \alpha$
- Regular (finite-state)
 - ✦ Rules: $A \rightarrow aB$; $A \rightarrow a$

Regular Language Example

- Nonterminals: S, X
- Terminals: m, o
- Rules:
 - $S \rightarrow mX$
 - $X \rightarrow oX$
 - $X \rightarrow o$
- Start symbol: S

One expansion

S

mX

moX

mooX

mooo

Another Regular Language

- Strings in and not in this language
 - ❖ In the language:
 - “ba!”, “baa!”, “baaaaaaa!”
 - ❖ Not in the language:
 - “ba”, “b!”, “ab!”, “bbaaa!”, “alibaba!”
- Regular expression: $baa^*!$
- Finite state automaton

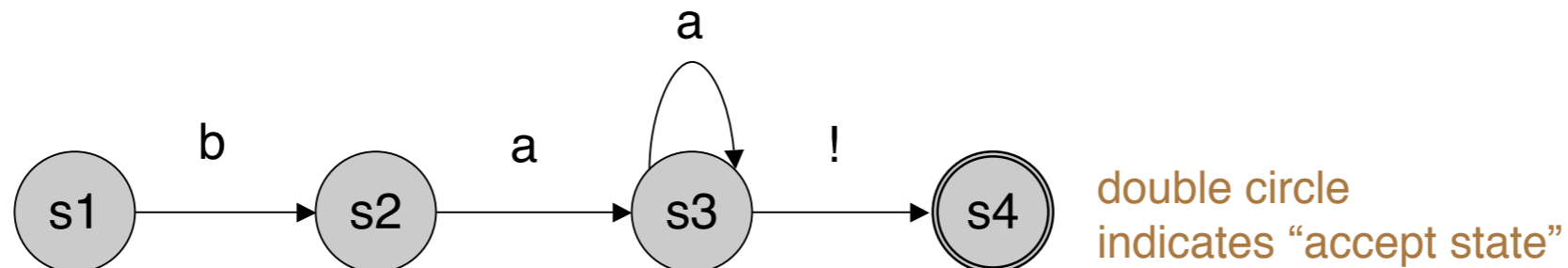

Regular Languages

Regular Languages
the accepted strings

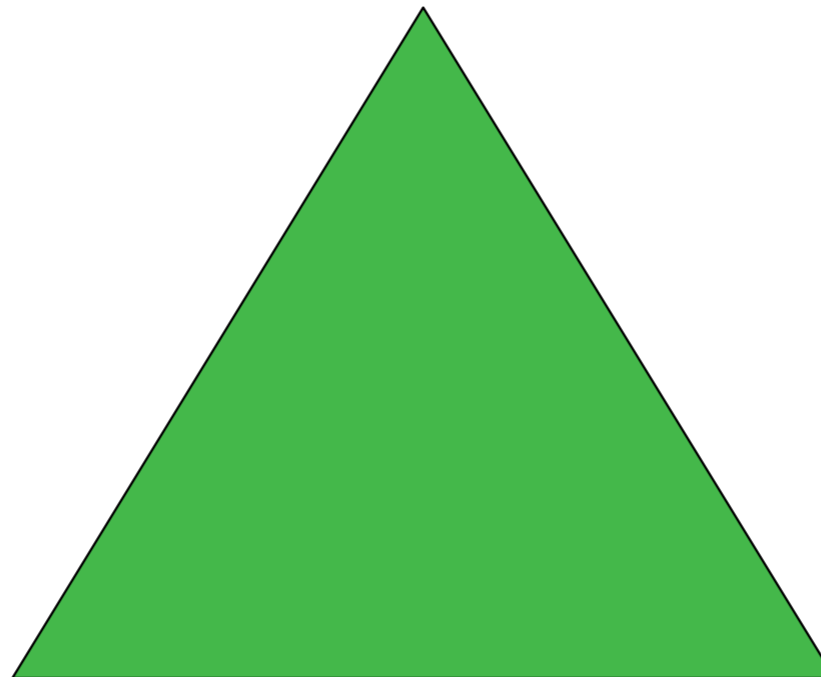

Finite-state Automata
machinery for accepting

Regular Expressions
a way to type the automata

Finite-State Automata

- A (deterministic) finite-state automaton is a 5-tuple $(Q, \Sigma, q_0, F, \delta(q,i))$
 - ❖ Q : finite set of states $q_0, q_1, q_2, \dots, q_N$
 - ❖ Σ : finite set of terminals
 - ❖ $\delta(q,i)$: transition function (relation if non-deterministic)
 - ❖ q_0 : start state
 - ❖ F : set of final states

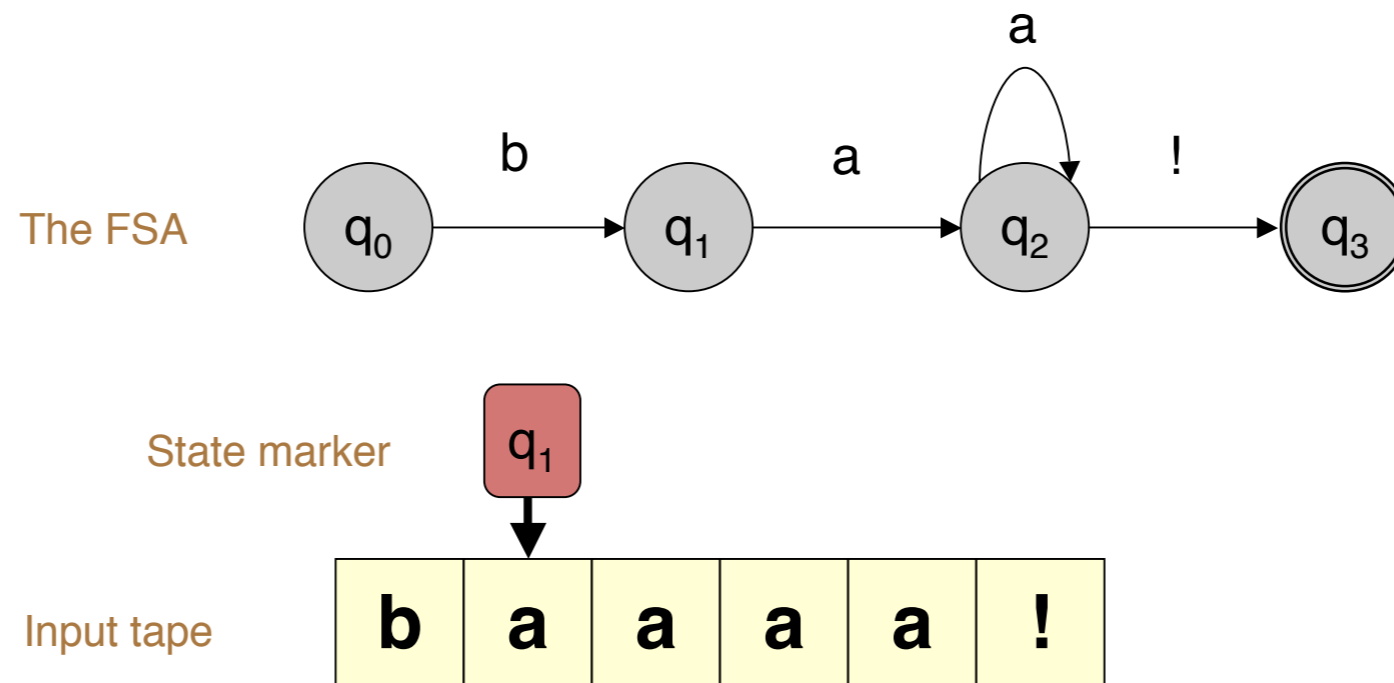

Transition Table

State	Input		
	<i>b</i>	<i>a</i>	<i>!</i>
0	1	∅	∅
1	∅	2	∅
2	∅	2	3
3	∅	∅	∅

Regular Expressions

- Two types of characters
- Literal
 - ❖ Every “normal” alphanumeric character is an RE, and matches itself
- Meta-characters
 - ❖ Special characters that allow you to combine REs in various ways
- Example:
 - ❖ a matches a
 - ❖ a^* matches ϵ or a or aa or aaa or ...

Regular Expressions

	Pattern	Matches
Concatenation	abc	<i>abc</i>
Disjunction	a b	<i>a b</i>
	(a bb) d	<i>ad bbd</i>
Kleene star	a*	<i>ε a aa aaa ...</i>
	c (a bb) *	<i>ca cbba</i>

The empty string

Regular expressions / FSAs are closed
under these operations

Practical Applications

- Word processing find & replace
- Validate fields in database (dates, email, ...)
- Searching for linguistic patterns
- Finite-state machines
 - ❖ Language modeling in speech recognition (where things need to be real-time or better)
 - ❖ Information extraction
 - ❖ Morphology

Syntactic Sugar

	Pattern	Matches
Character Concat	went	went
Alternatives	(go went)	go went
disjunc. negation	[aeiou]	a o u
wildcard char	[^aeiou]	b c d f g
	.	a z &
Loops & skips	a*	ϵ a aa aaa ...
one or more	a+	a aa aaa
zero or one	colou?r	color colour

Syntactic Sugar

- Special characters
 - `\t` tab
 - `\n` newline
 - `\v` vertical tab
 - `\r` carriage return
- Aliases (shorthand)
 - `\d` digits [0-9]
 - `\D` non-digits [^0-9]
 - `\w` alphabetic [a-zA-Z]
 - `\W` non-alphabetic [^a-zA-Z]
 - `\s` whitespace [\t\n\r\f\v]
 - `\w` alphabetic [a-zA-Z]
- Examples
 - `\d+ dollars` 3 dollars, 50 dollars, 982 dollars
 - `\w*oo\w*` food, boo, oodles
- Escape character
 - `\` is the general escape character; e.g. `\.` is not a wildcard, but matches a period `.`
 - if you want to use `\` in a string it has to be escaped `\\`

Syntactic Sugar

- **Anchors**. AKA, “zero width characters”.
- They match positions in the text.
 - `^` beginning of line
 - `$` end of line
 - `\b` word boundary, i.e. location with `\w` on one side but not on the other.
 - `\B` negated word boundary, i.e. any location that would not match `\b`
- Examples:
 - `\bthe\b` the together
- **Counters** `{1}`, `{1,2}`, `{3,}`

Syntactic Sugar

- **Grouping**
 - **a (good|bad) movie**
 - **He said it (again and)*again.**
- Parens also indicate **Registers** (saved contents)
 - **b(\w+)h\1**
matches *boohoo* and *baha*, but not *boohaa*
The digit after the \ indicates which of multiple paren groups, as ordered by when then were opened.
- Grouping without the cost of register saving
 - **He went (? :this|that) way.**

Syntactic Sugar

- Non-consuming tests
 - `(?=...)` - Positive lookAHEAD
 - `(?!...)` - Negative lookAHEAD
 - `(?<=...)` - Positive lookBEHIND
 - `(?<!...)` - Negative lookBEHIND
- Example
 - `(?<=[Hh]e) \w+ed (=?\w+ly)`

ELIZA (Weizenbaum 1966)

User: Men are all alike.

ELIZA: IN WHAT WAY?

User: They're always bugging us about something or other.

ELIZA: CAN YOU THINK OF A SPECIFIC EXAMPLE?

User: Well, my boyfriend made me come here.

ELIZA: YOUR BOYFRIEND MADE YOU COME HERE.

User: He say's I'm depressed much of the time.

ELIZA: I'M SORRY TO HEAR THAT YOU ARE DEPRESSED.

Implemented with regular expression substitution!

s/. * I'm (depressed|sad) .*/I AM SORRY TO HEAR THAT YOU ARE \1/

s/. * always .*/CAN YOU THINK OF A SPECIFIC EXAMPLE?/

Reading

- Karttunen, Chanod, Grefenstette, Schiller. Regular expressions for language engineering. *JNLE*, 1997.

<http://www.stanford.edu/~laurik/publications/jnle-97/rele.pdf>

- RE/FSA background: Jurafsky & Martin, c.2

Finite-State Machines: Acceptors and Transducers

Finite state acceptors (FSAs)

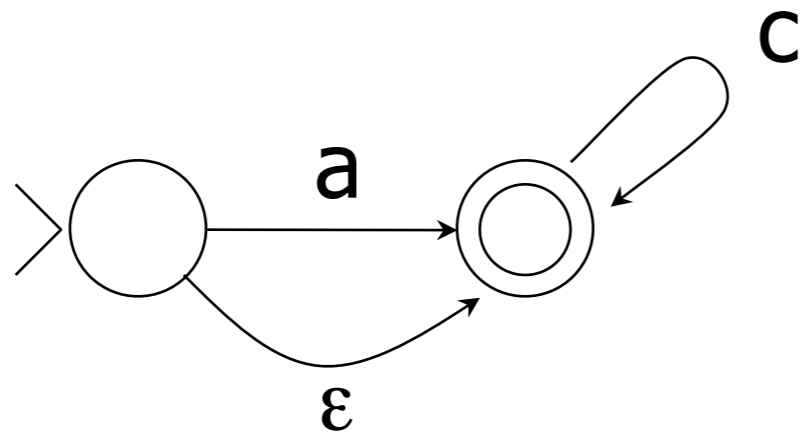

Finite state acceptors (FSAs)

- Regexps

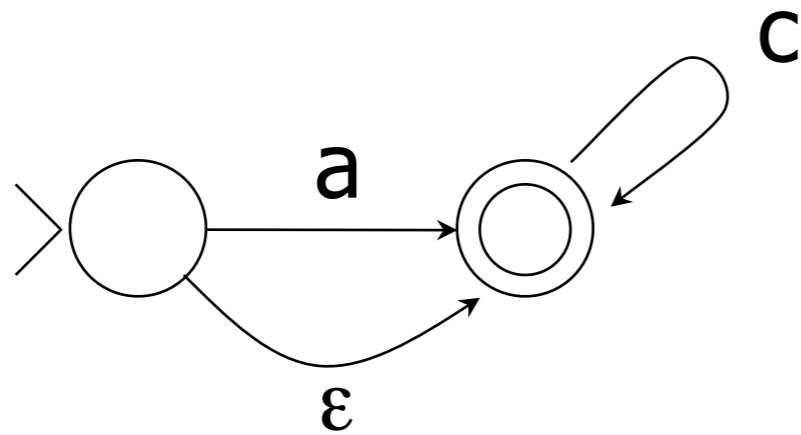

Finite state acceptors (FSAs)

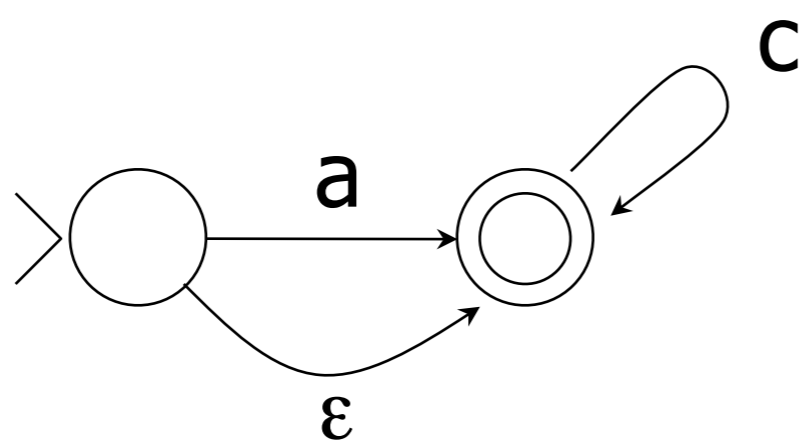

- Regexps
- Union, Kleene *, concat, intersect, complement, reversal

Finite state acceptors (FSAs)

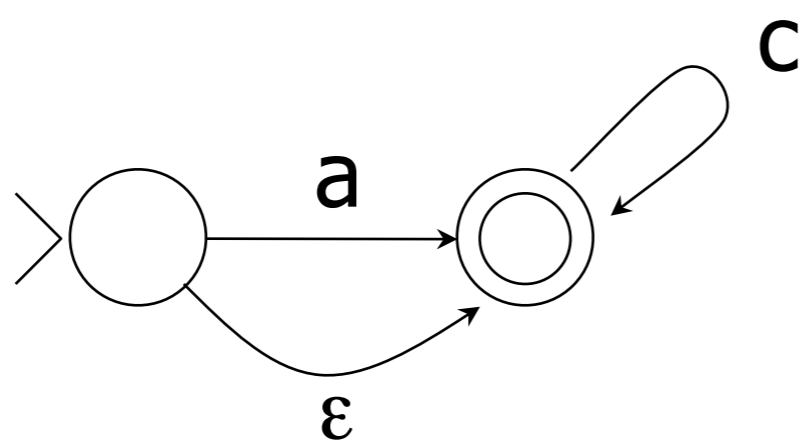

- Regexp
- Union, Kleene $*$, concat, intersect, complement, reversal
- Determinization, minimization

Finite state acceptors (FSAs)

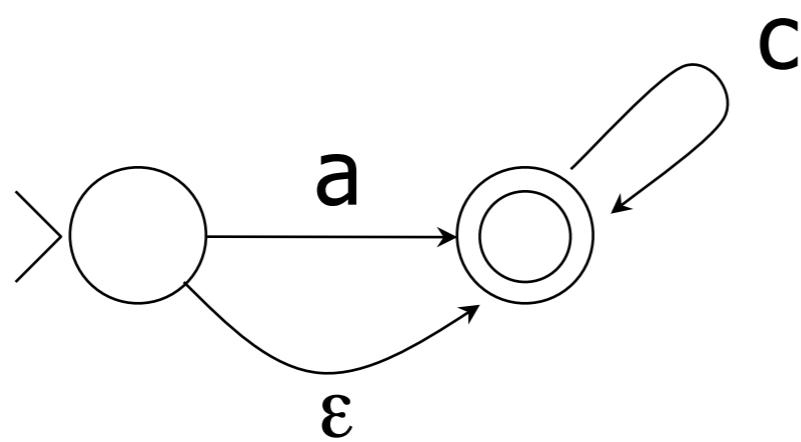

- Regexps
- Union, Kleene $*$, concat, intersect, complement, reversal
- Determinization, minimization
- Pumping, Myhill-Nerode

A useful FSA ...

Wordlist

clear
clever
ear
ever
fat
father

`/usr/dict/words`

25K words
206K chars

0.6 sec

FSM

17728 states,
37100 arcs

A useful FSA ...

Wordlist

clear
clever
ear
ever
fat
father

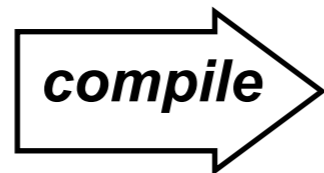

Network

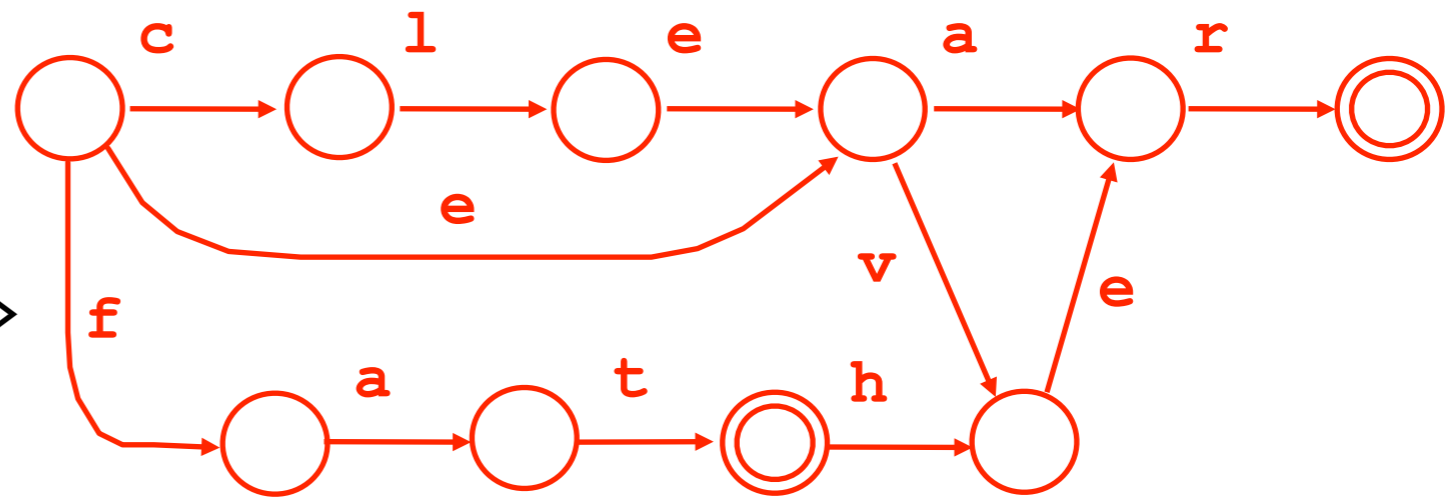

`/usr/dict/words`

25K words
206K chars



FSM
17728 states,
37100 arcs

Weights are useful here too!

Wordlist

clear	0
clever	1
ear	2
ever	3
fat	4
father	5

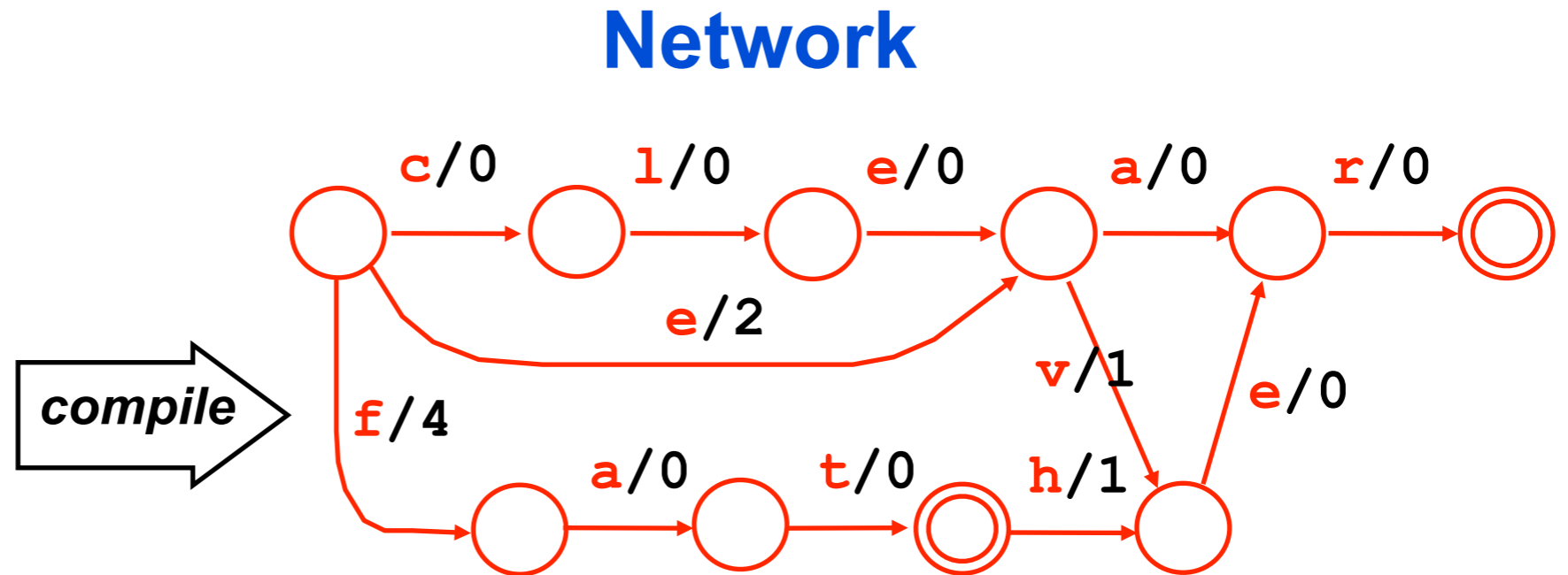

Computes a perfect hash!

Example: Weighted acceptor

Wordlist

clear	0
clever	1
ear	2
ever	3
fat	4
father	5

compile

Network

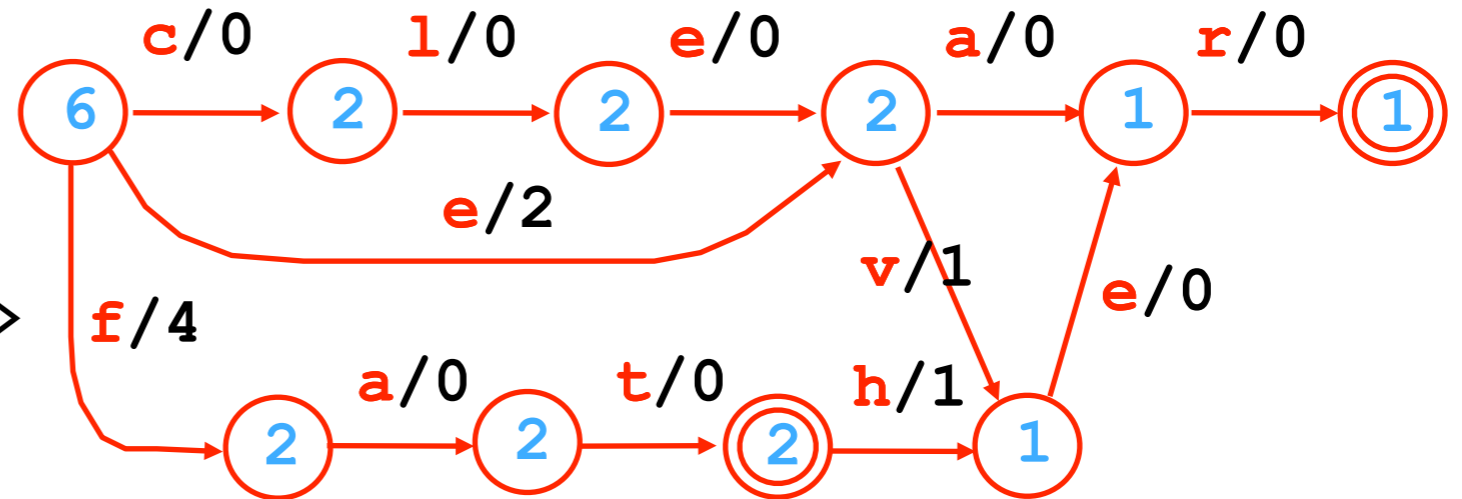

- Compute **number of paths** from each state (**Q: how?**)
A: recursively, like DFS
- Successor states partition the path set
- Use offsets of successor states as arc weights
- **Q: Would this work for an arbitrary numbering of the words?**

Example: Unweighted transducer

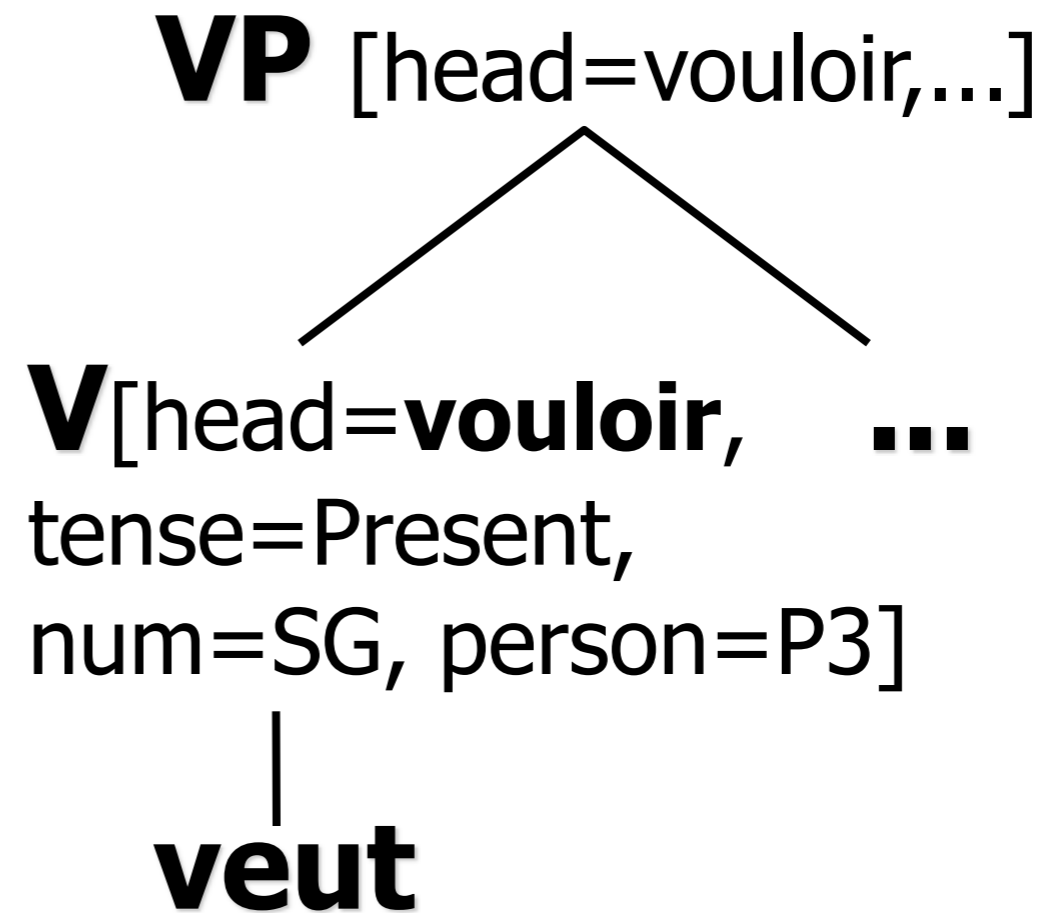

Example: Unweighted transducer

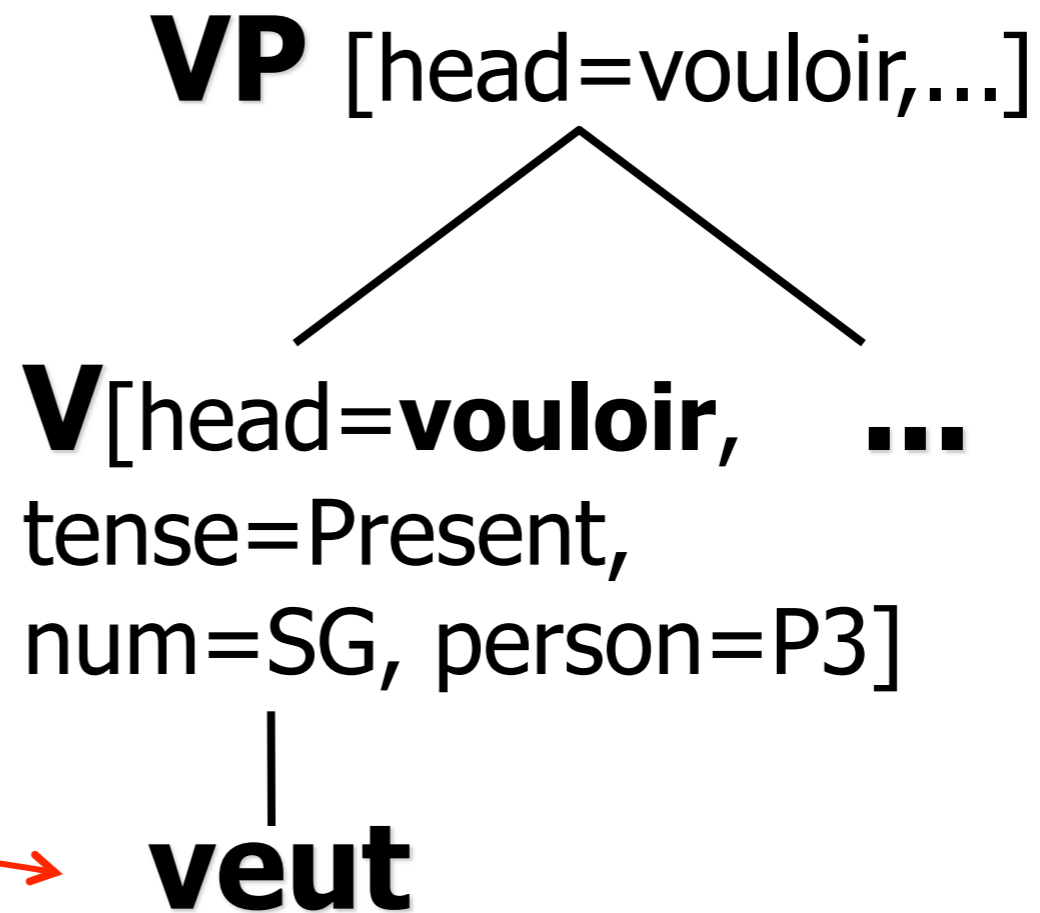

the problem
of **morphology**
("word shape") -
an area of linguistics

Example: Unweighted transducer

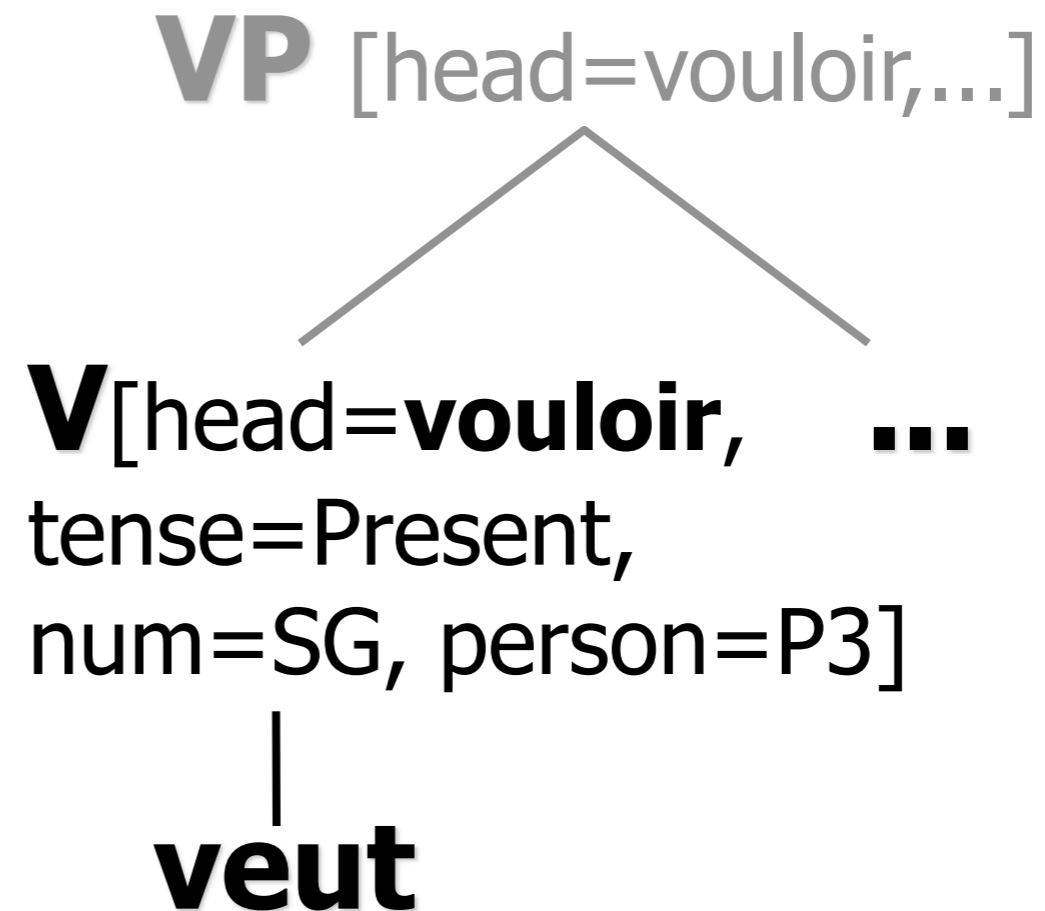
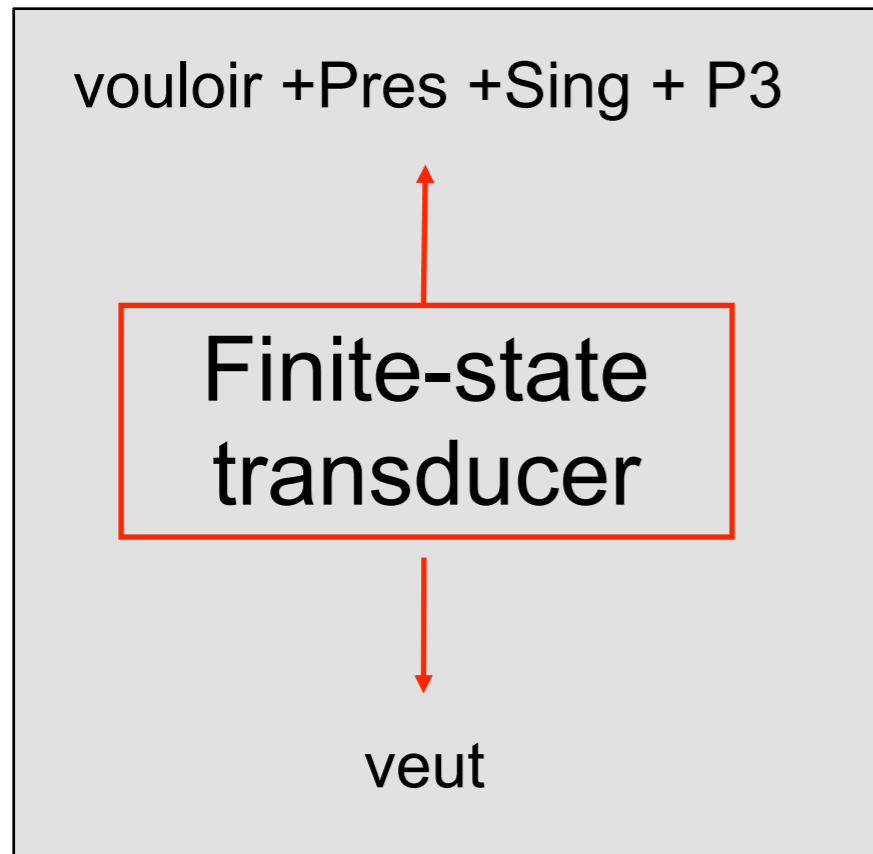

Example: Unweighted transducer

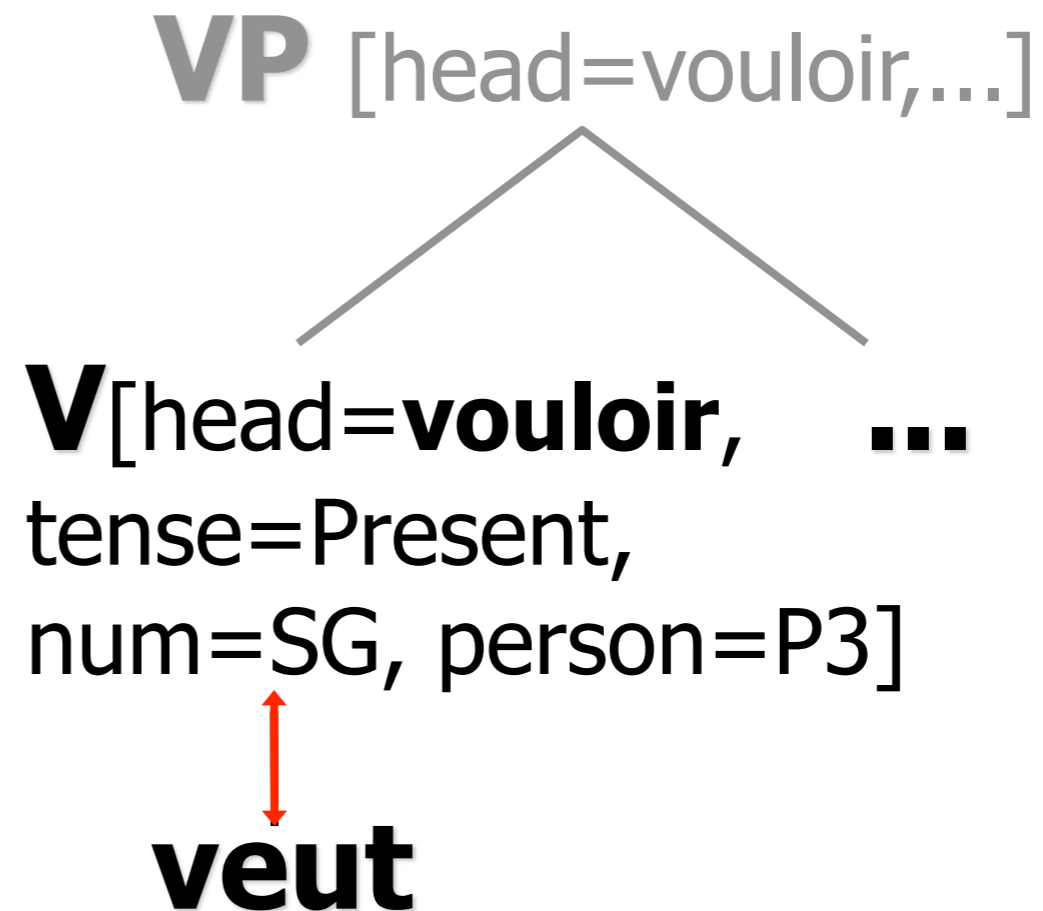
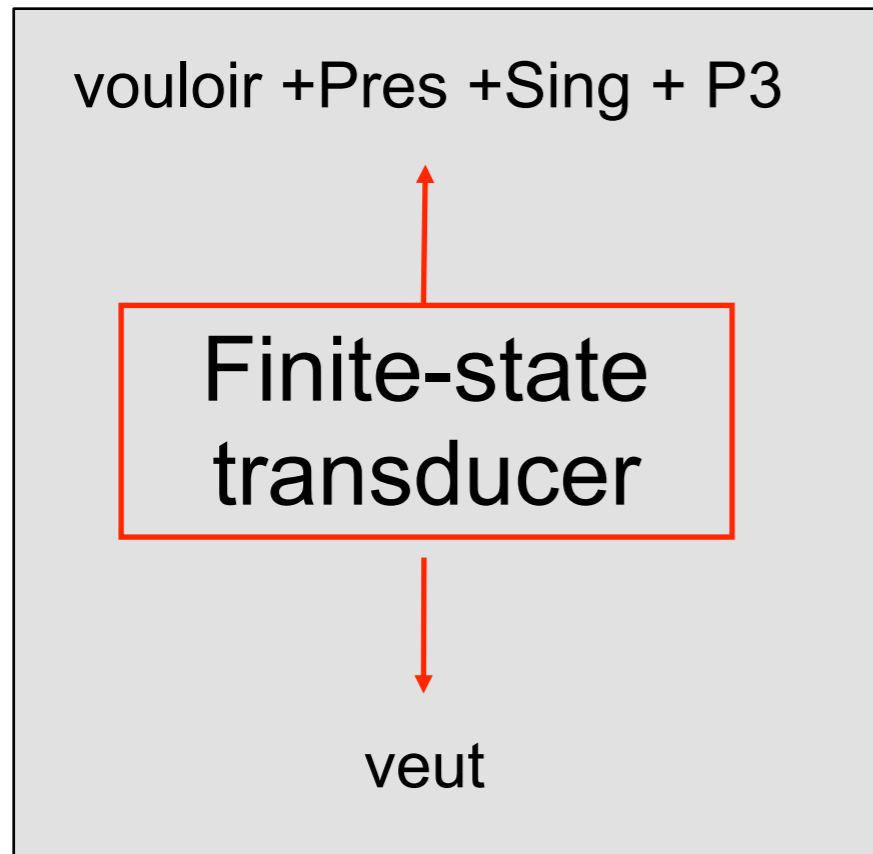

Example: Unweighted transducer

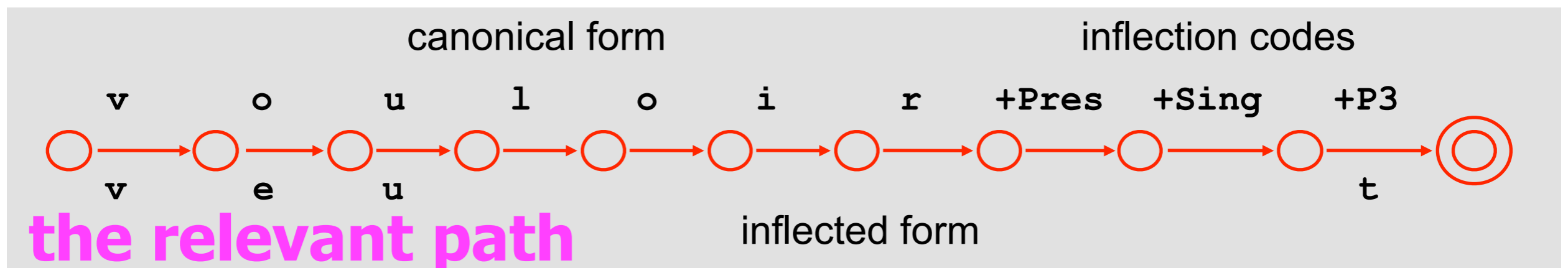
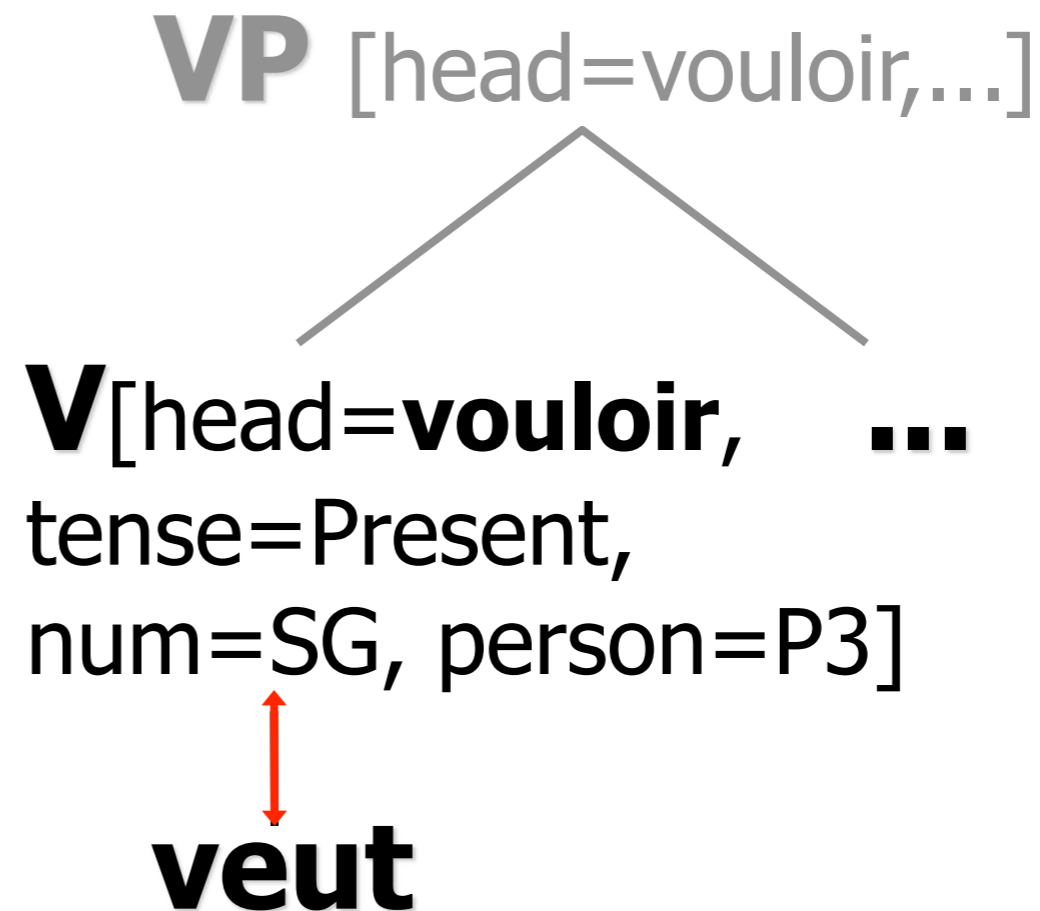
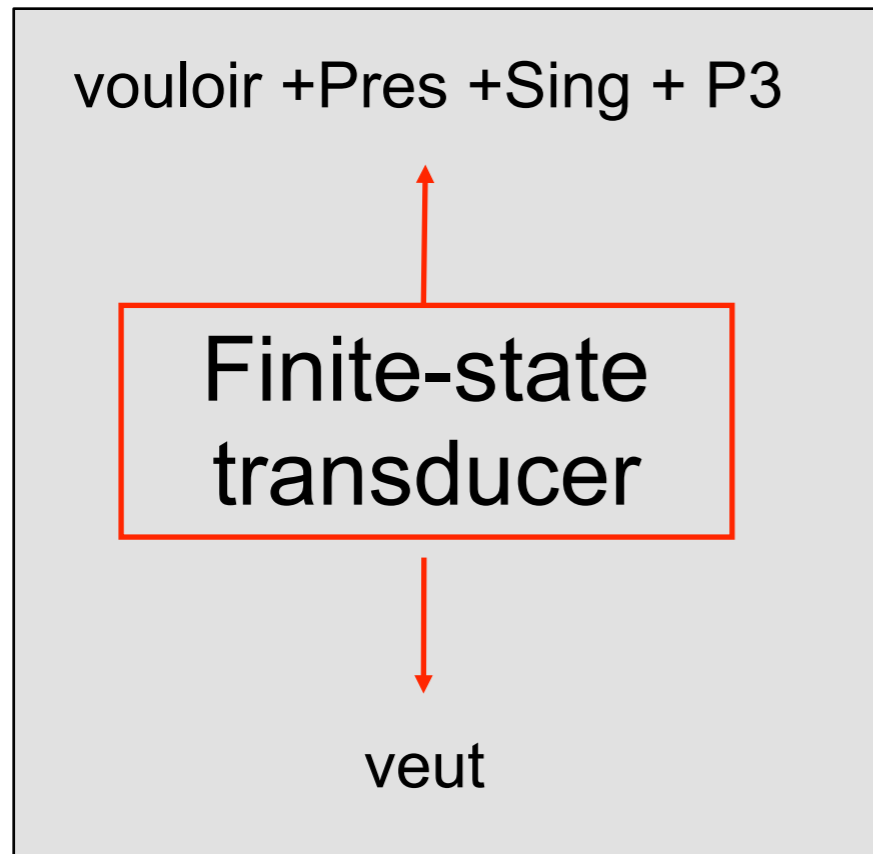

Example: Unweighted transducer

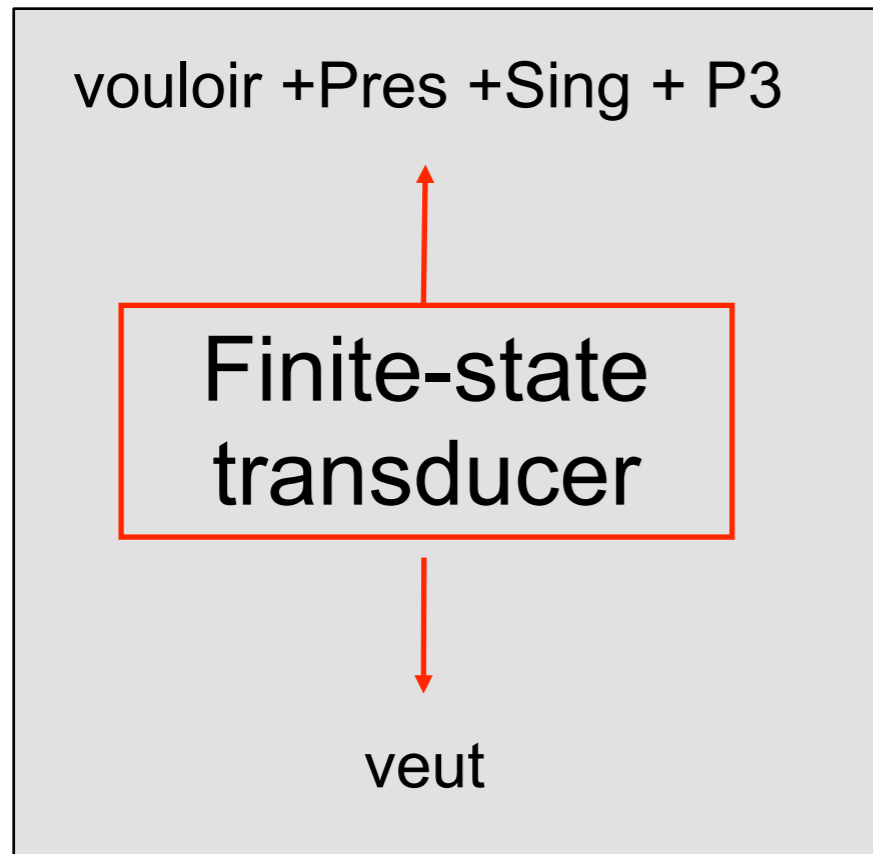

- Bidirectional: generation or analysis
- Compact and fast
- Xerox sells for about 20 languages including English, German, Dutch, French, Italian, Spanish, Portuguese, Finnish, Russian, Turkish, Japanese, ...
- Research systems for many other languages, including Arabic, Malay

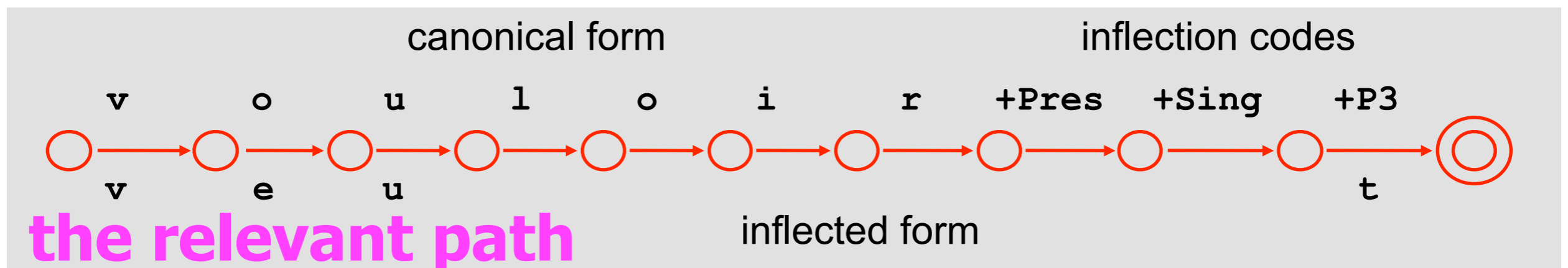

Regular Relation (of strings)

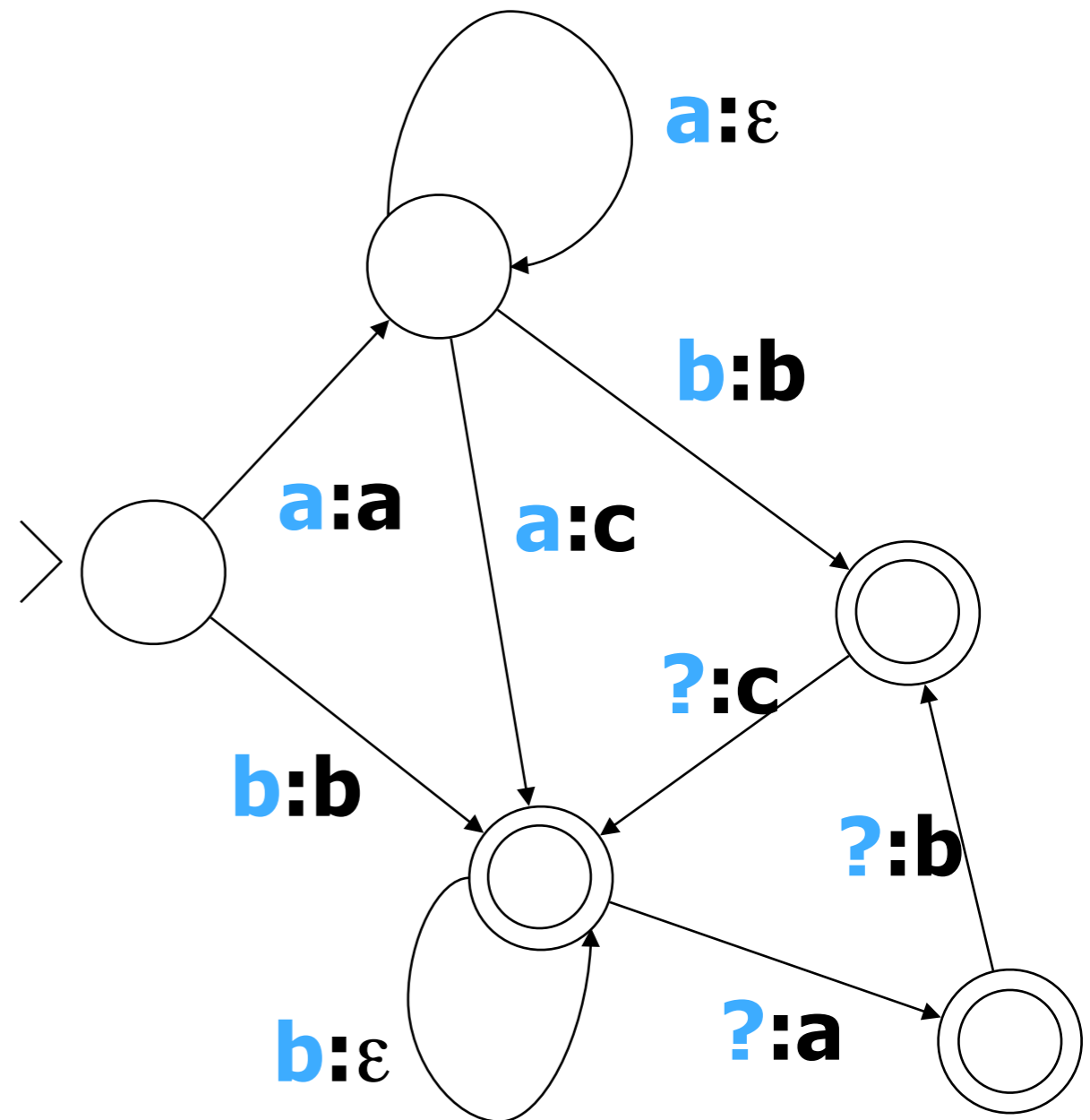

Regular Relation (of strings)

- Relation: like a function, but multiple outputs ok

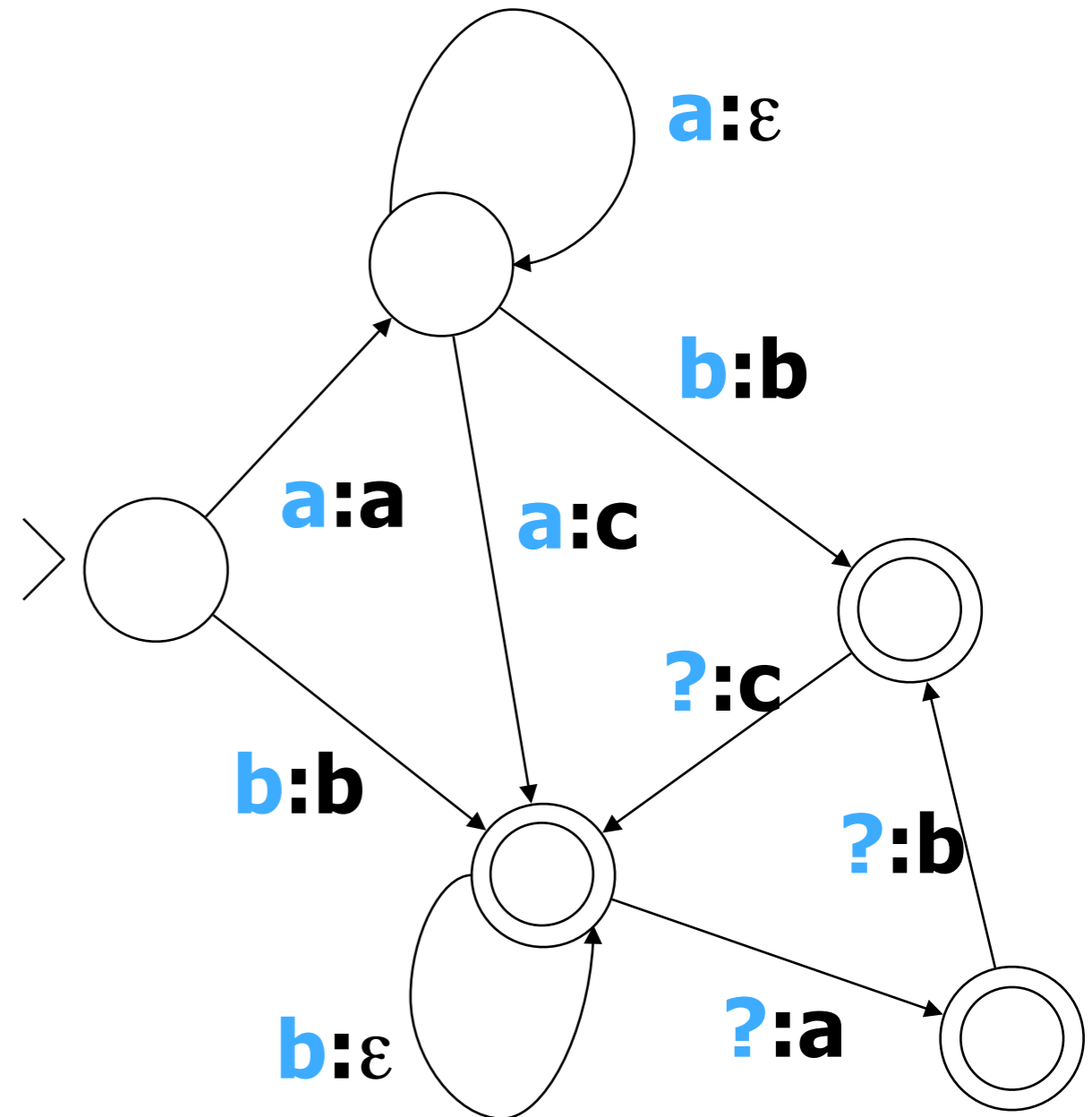

Regular Relation (of strings)

- Relation: like a function, but multiple outputs ok
- Regular: finite-state

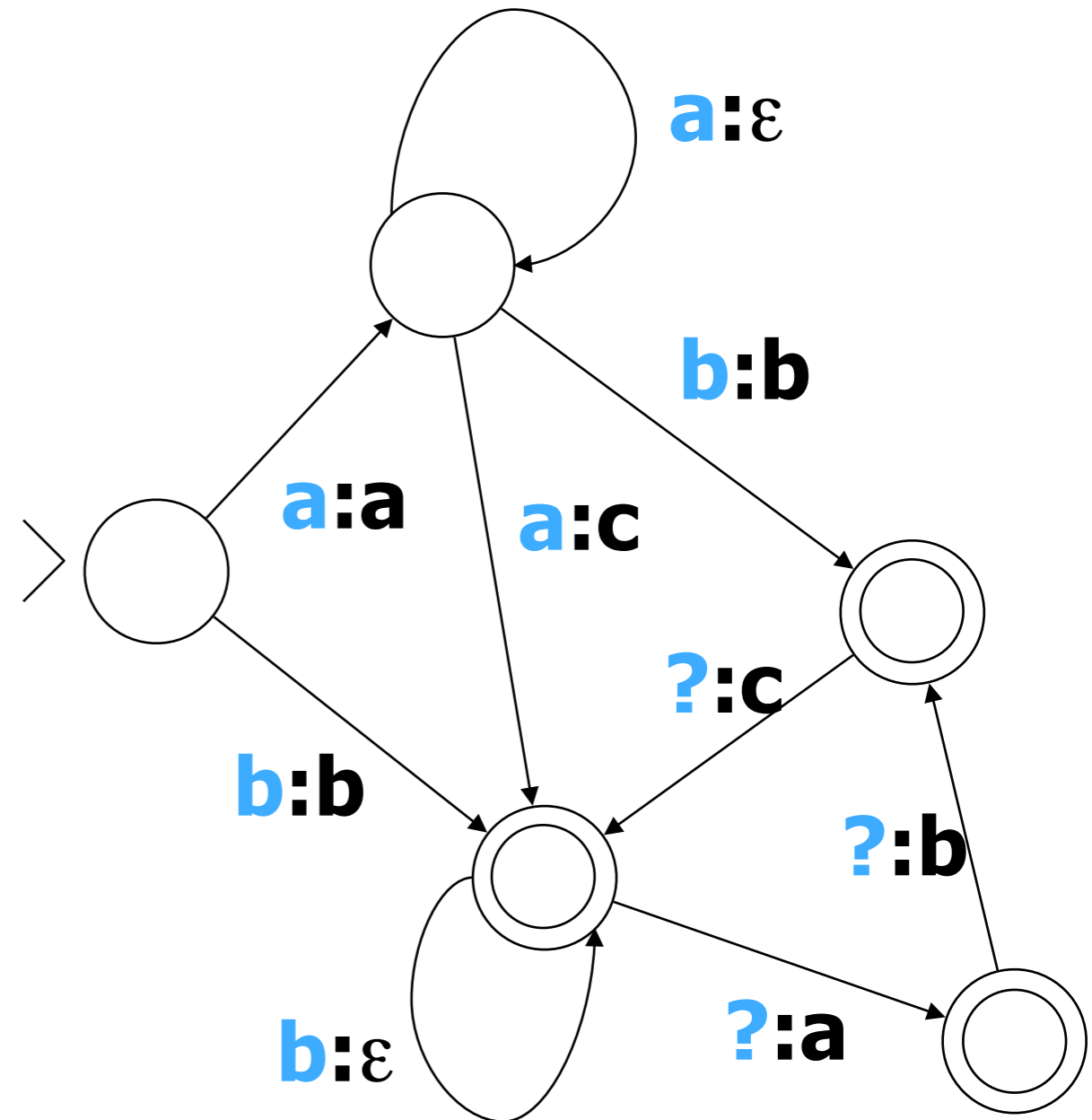

Regular Relation (of strings)

- Relation: like a function, but multiple outputs ok
- Regular: finite-state
- Transducer: automaton w/ outputs

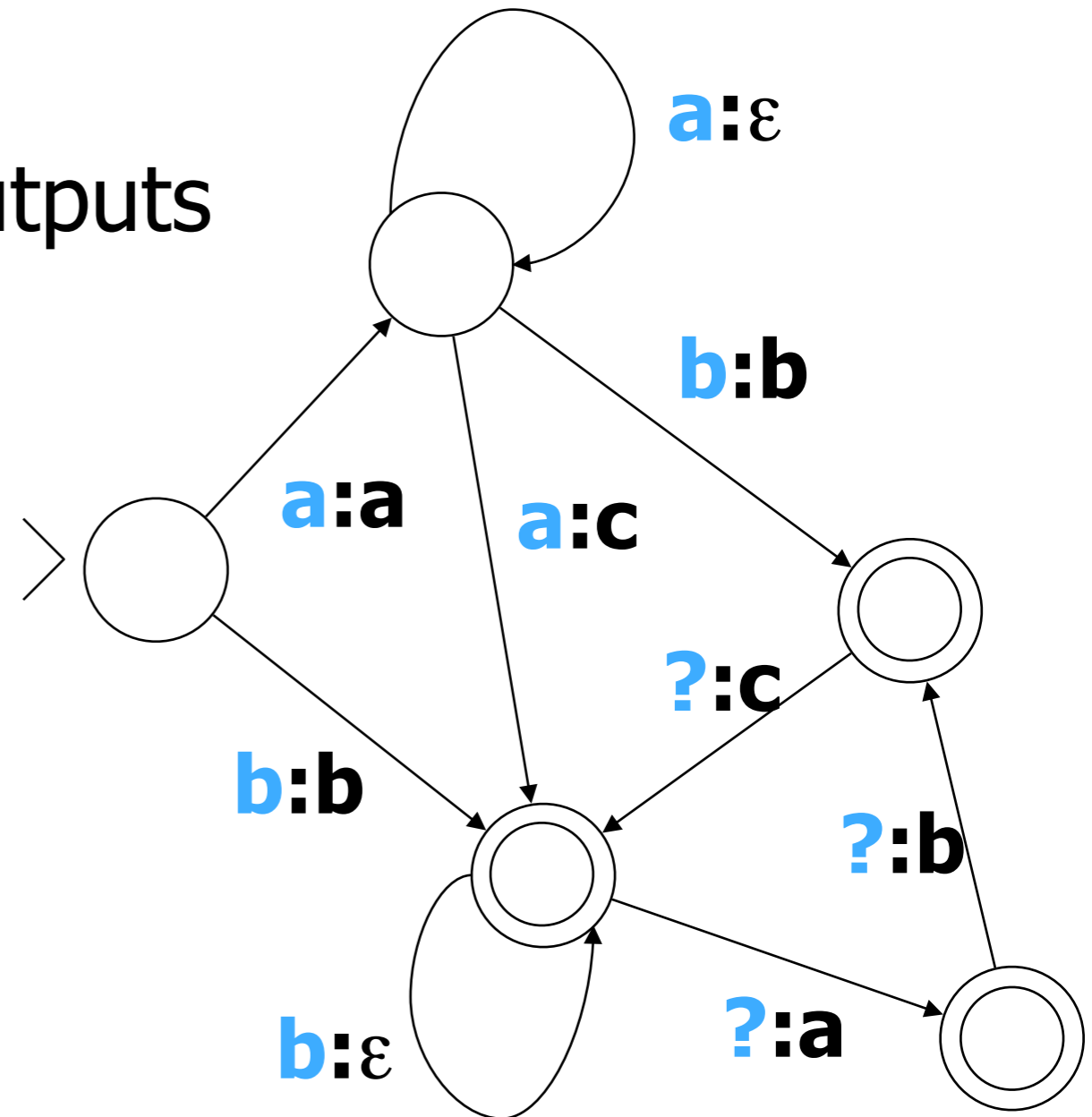

Regular Relation (of strings)

- Relation: like a function, but multiple outputs ok
- Regular: finite-state
- Transducer: automaton w/ outputs

■ $b \rightarrow ?$ $a \rightarrow ?$

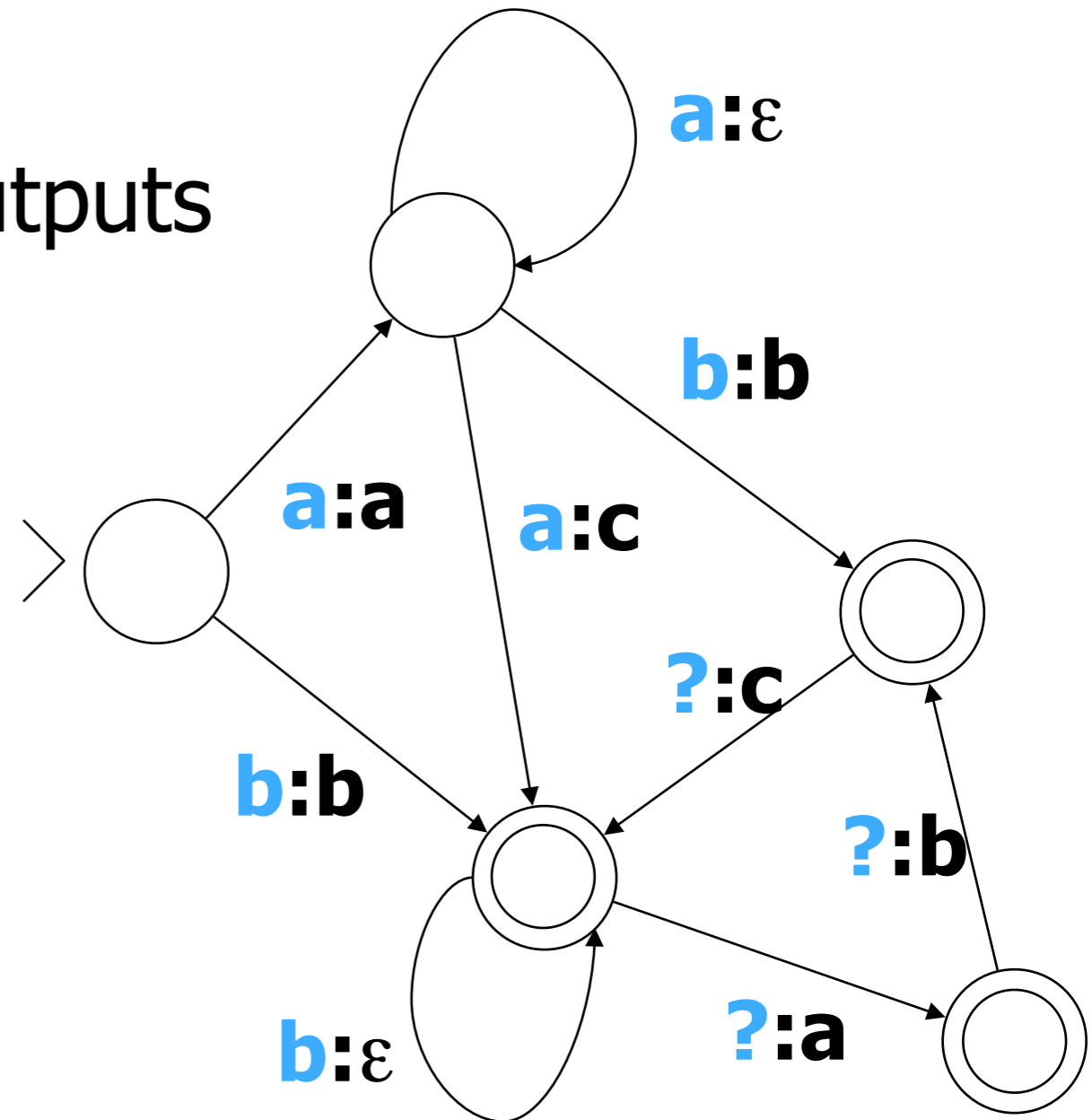

Regular Relation (of strings)

- Relation: like a function, but multiple outputs ok
- Regular: finite-state
- Transducer: automaton w/ outputs

■ $b \rightarrow \{b\}$ $a \rightarrow ?$

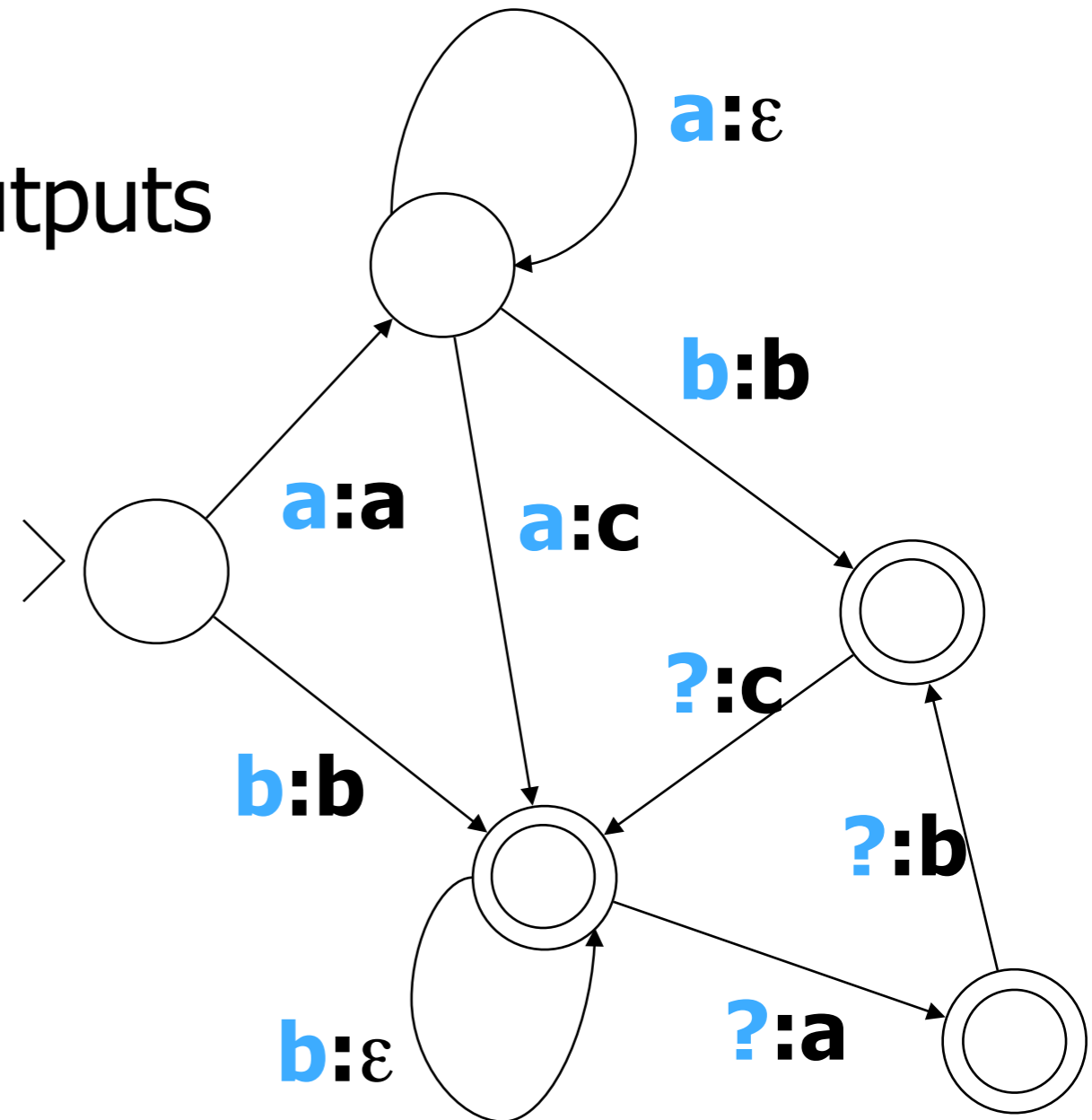

Regular Relation (of strings)

- Relation: like a function, but multiple outputs ok
- Regular: finite-state
- Transducer: automaton w/ outputs

■ $b \rightarrow \{b\}$ $a \rightarrow \{\}$

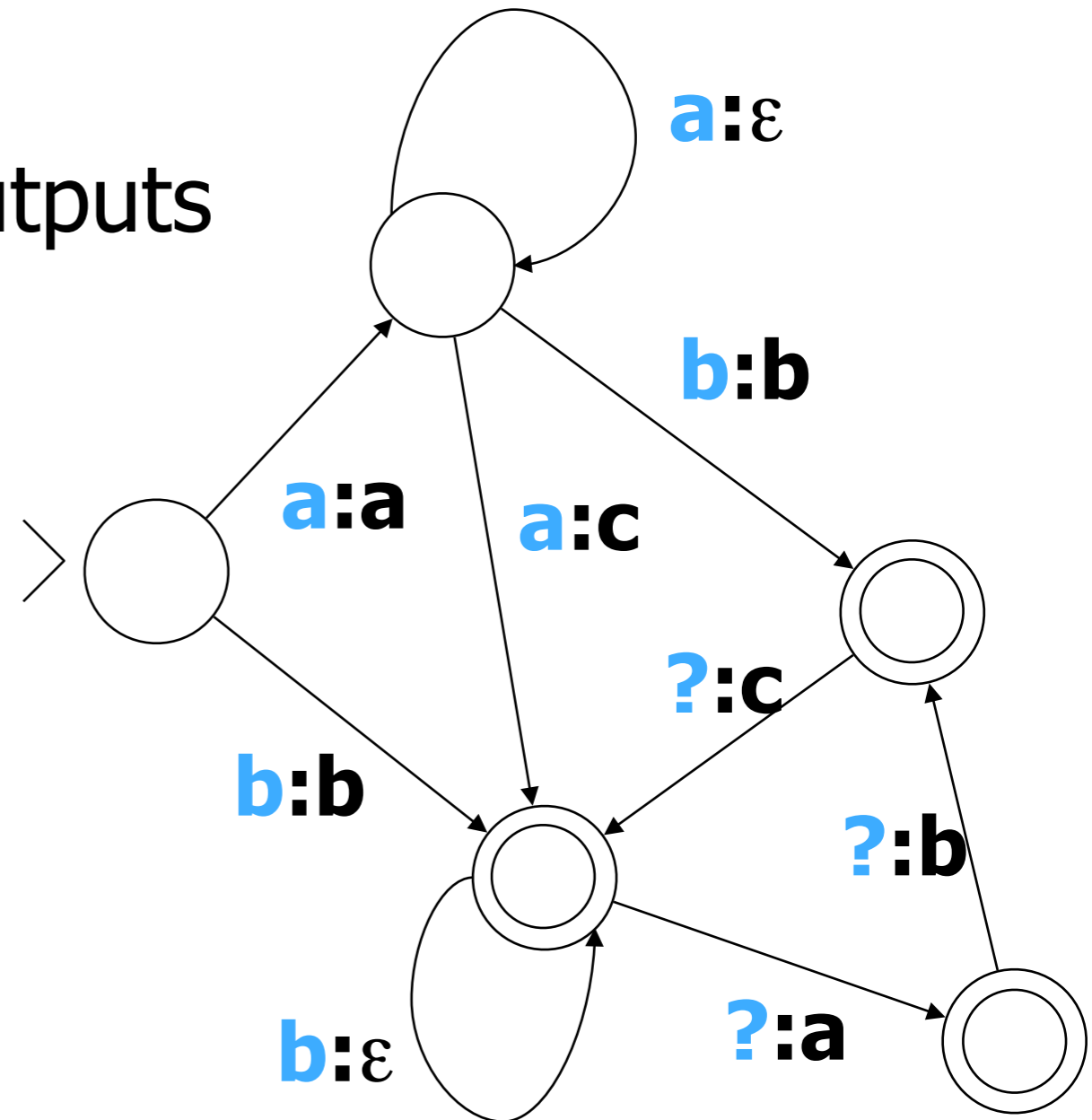

Regular Relation (of strings)

- Relation: like a function, but multiple outputs ok
- Regular: finite-state
- Transducer: automaton w/ outputs

- $b \rightarrow \{b\}$ $a \rightarrow \{\}$
 $\{ac, aca, acab,$
 $acabc\}$

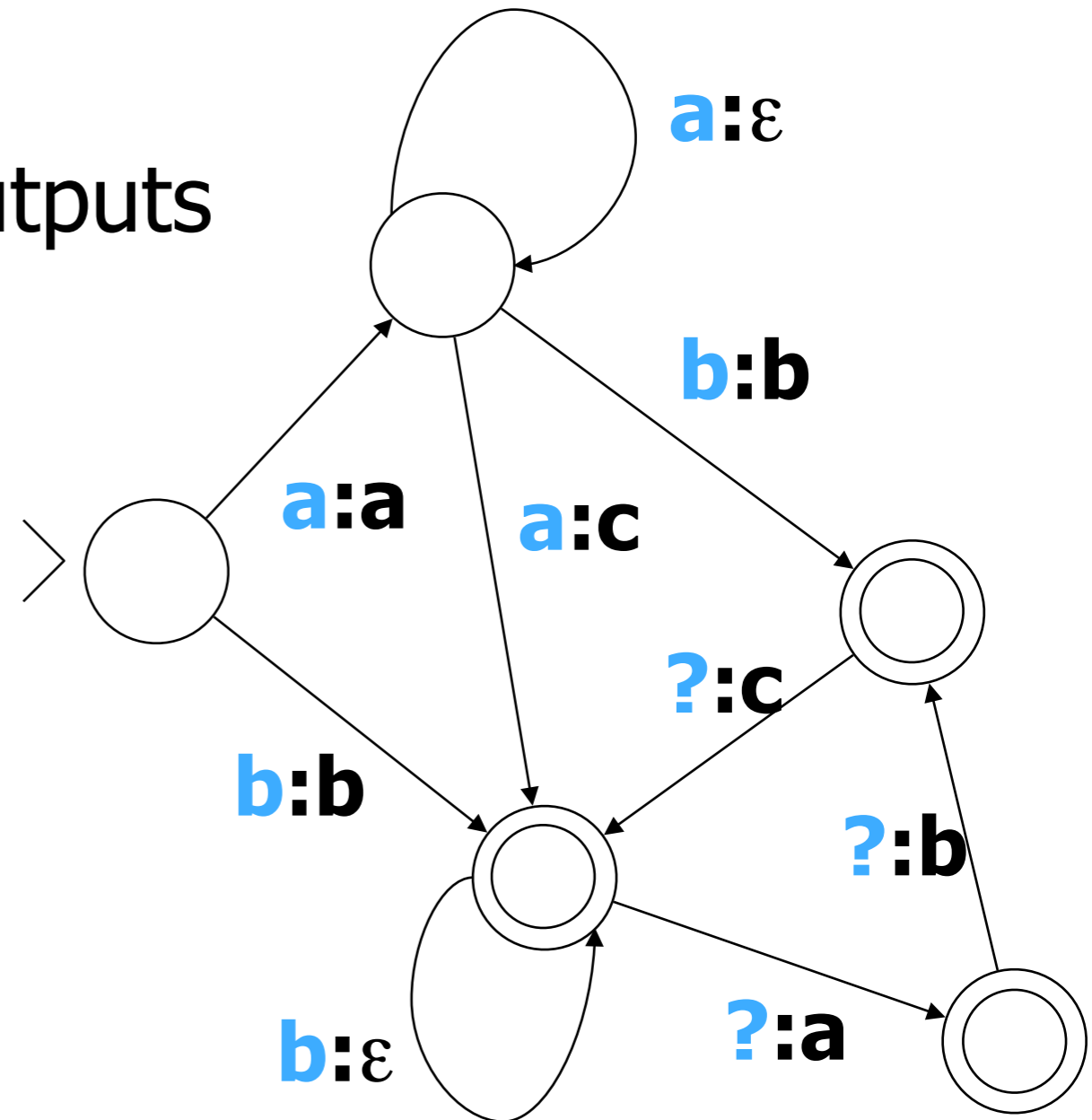

Regular Relation (of strings)

- Relation: like a function, but multiple outputs ok
- Regular: finite-state
- Transducer: automaton w/ outputs

■ $b \rightarrow \{b\}$ $a \rightarrow \{\}$
 $\{ac, aca, acab,$
 $acabc\}$

■ Invertible?

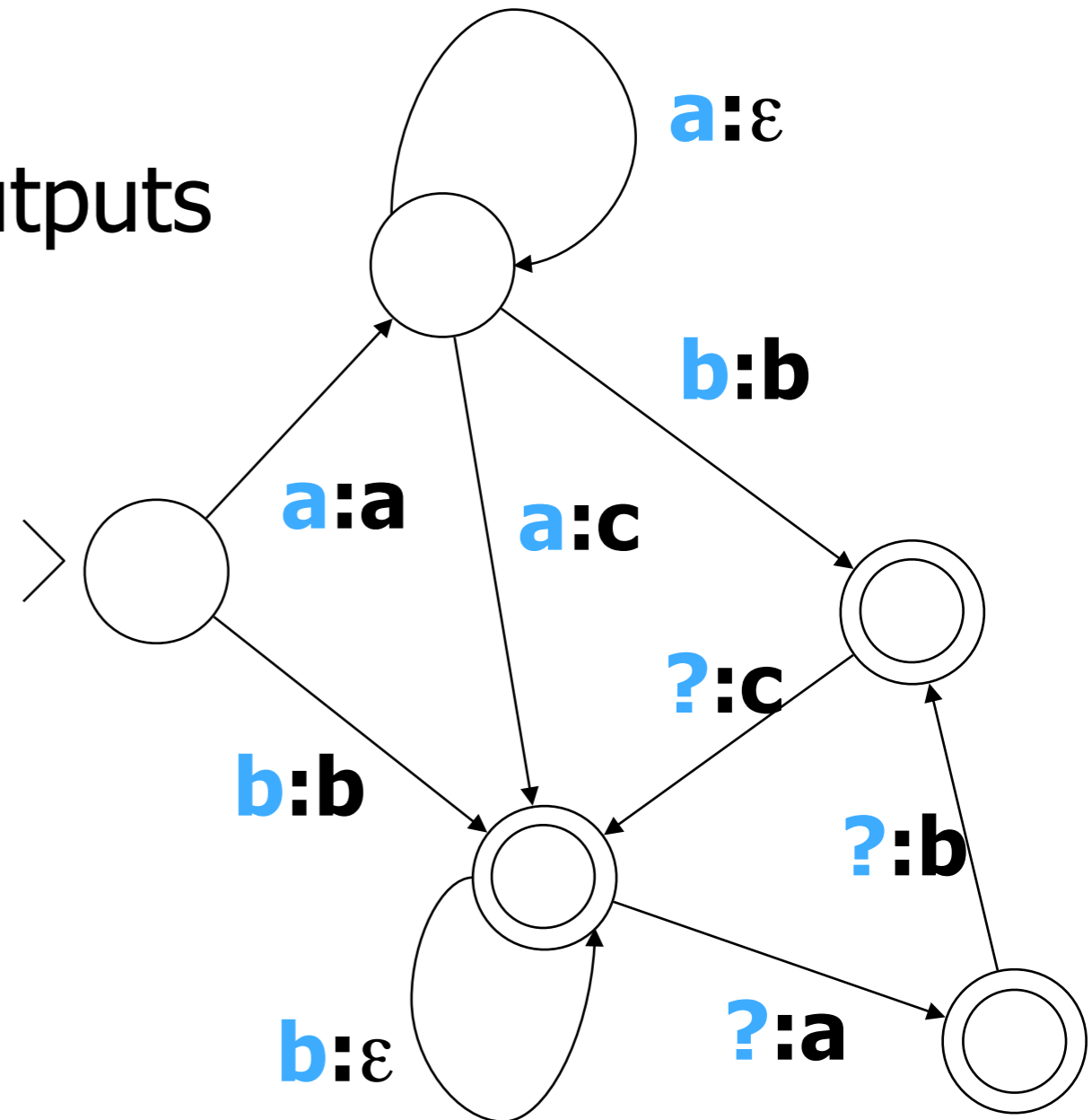

Regular Relation (of strings)

- Relation: like a function, but multiple outputs ok
- Regular: finite-state
- Transducer: automaton w/ outputs

■ $b \rightarrow \{b\}$ $a \rightarrow \{\}$
 $\{ac, aca, acab,$
 $acabc\}$

■ Invertible?

■ Closed under composition?

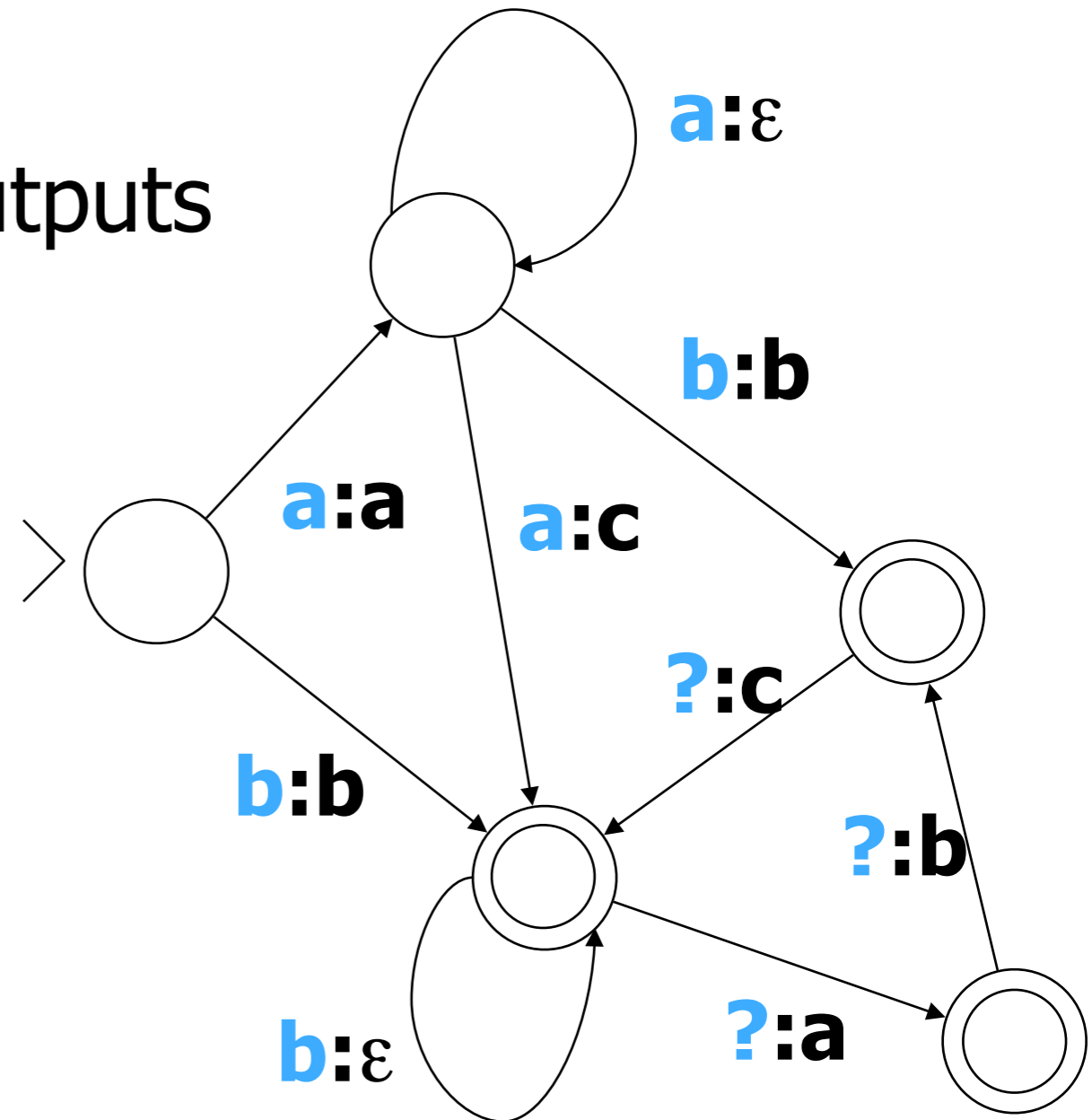

Regular Relation (of strings)

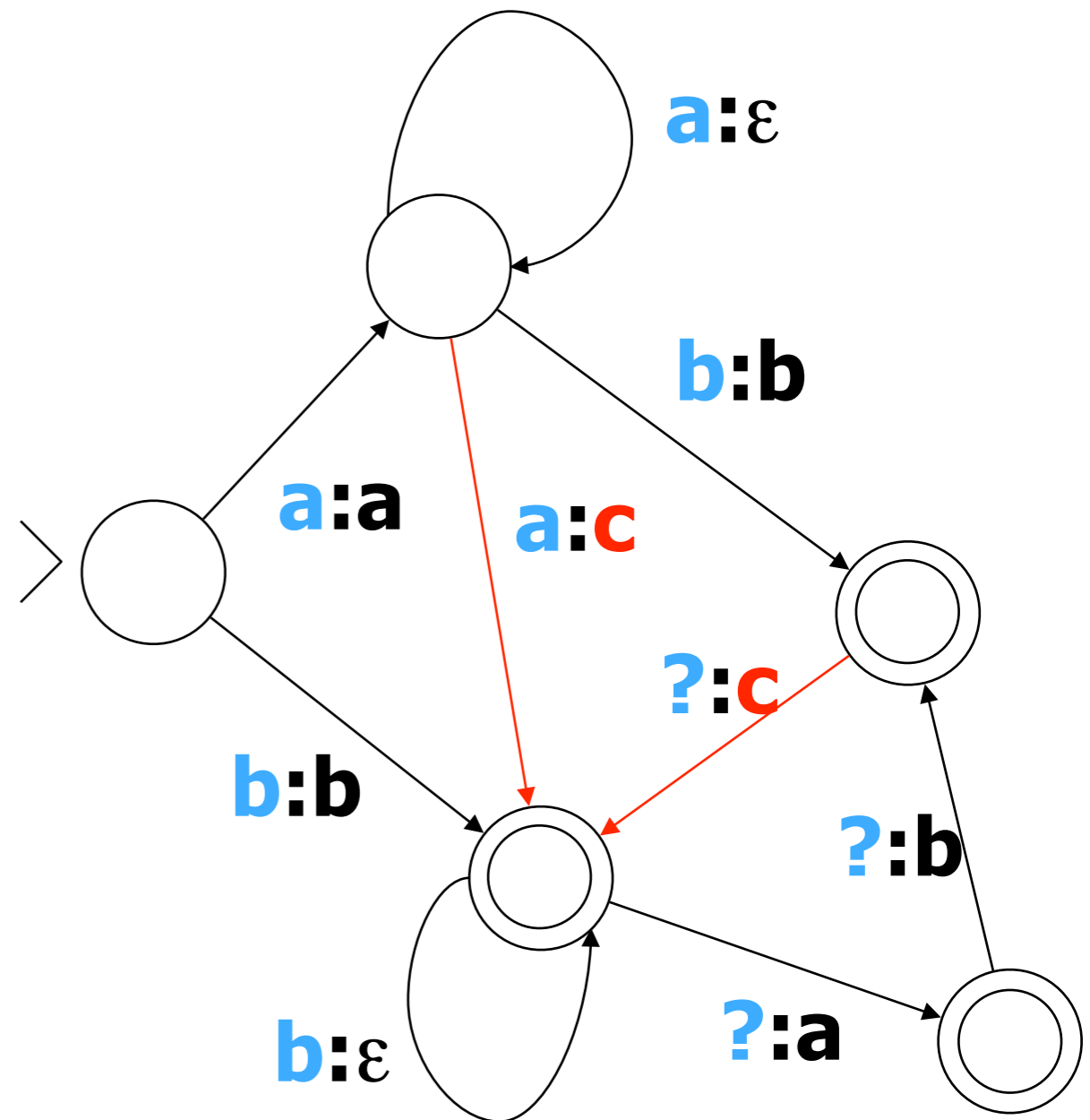

Regular Relation (of strings)

- Can weight the arcs: \rightarrow vs. \rightarrow

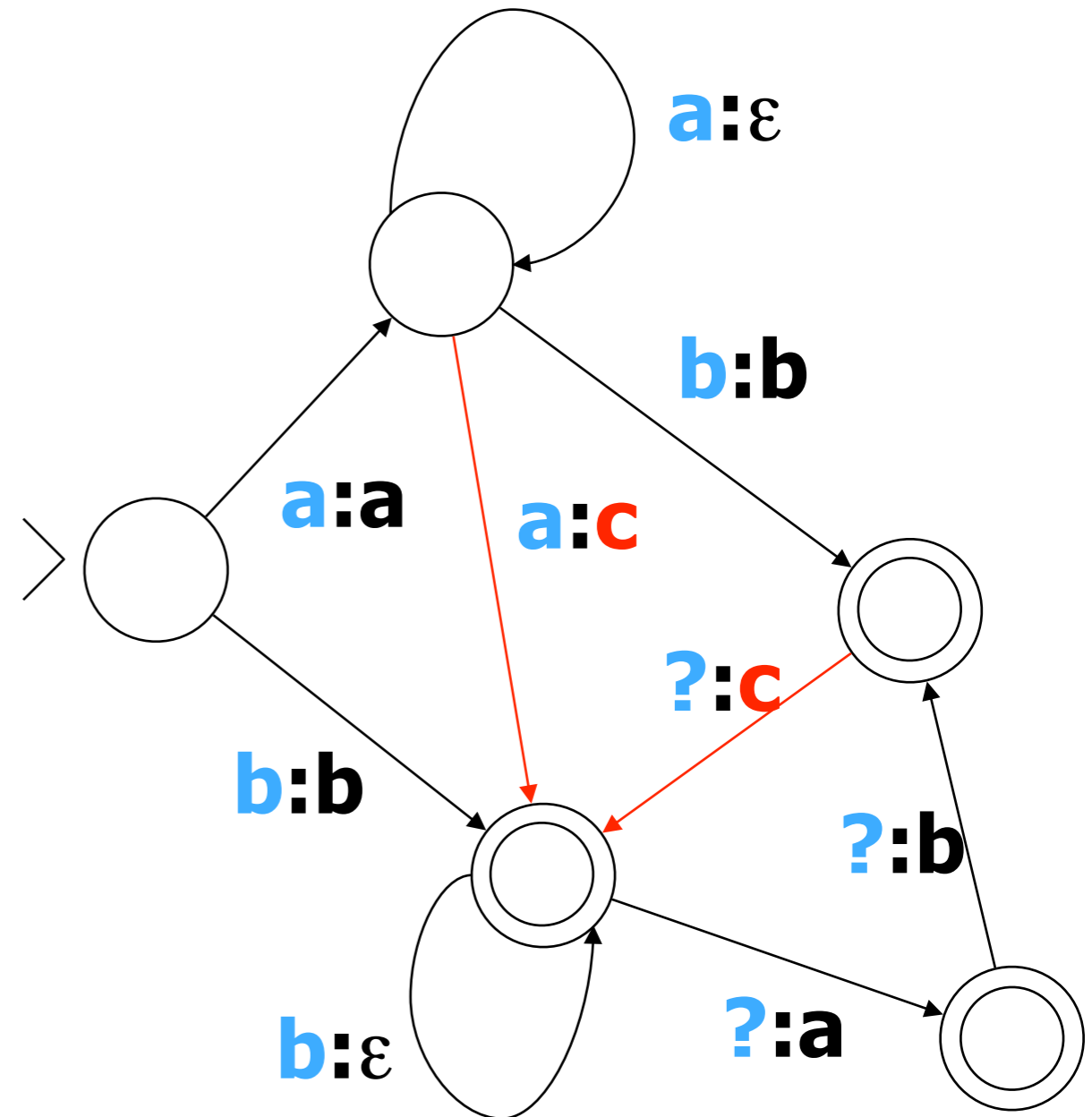

Regular Relation (of strings)

- Can weight the arcs: \rightarrow vs. \rightarrow
- $b \rightarrow \{b\}$ $a \rightarrow \{\}$

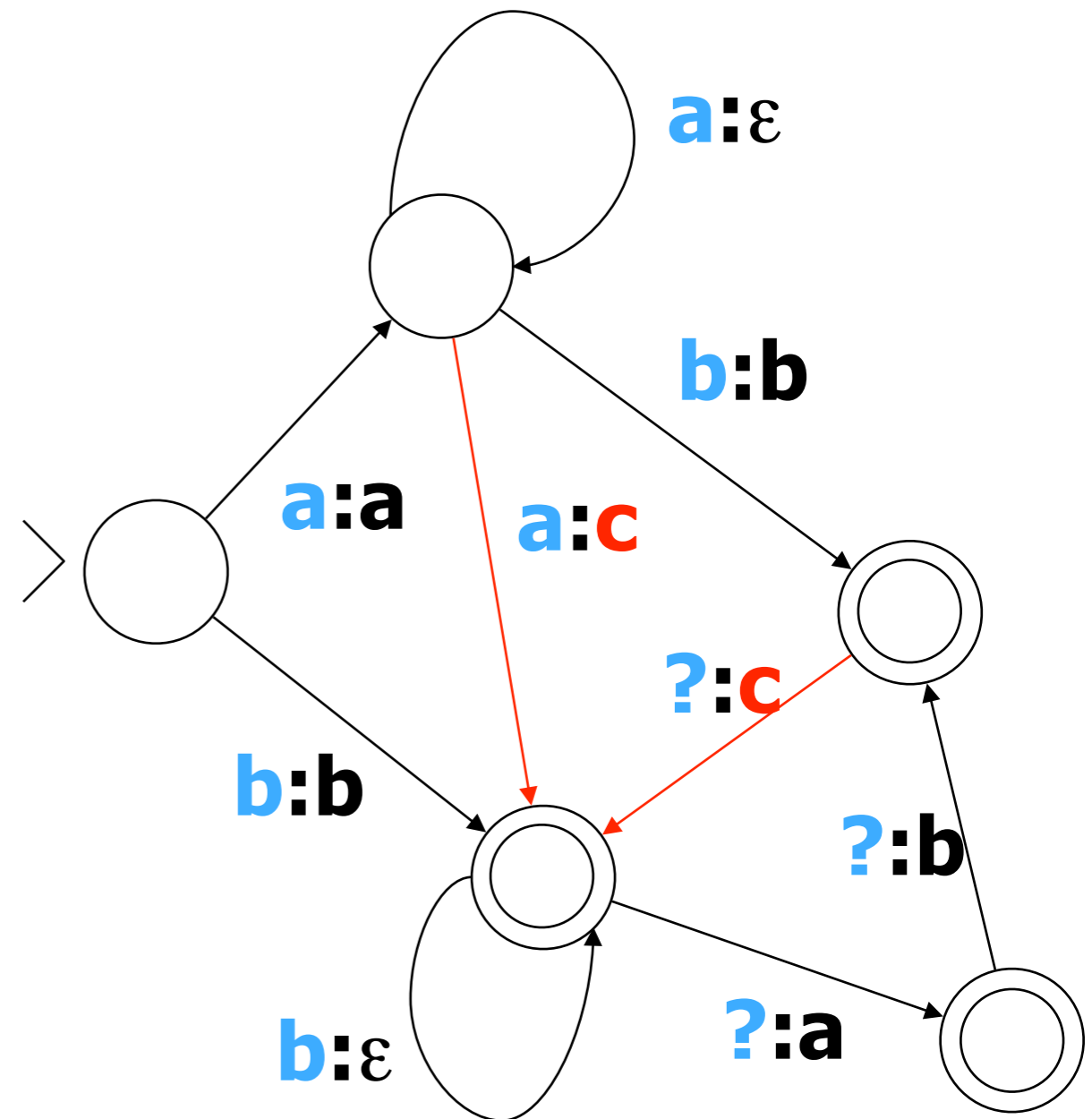

Regular Relation (of strings)

- Can weight the arcs: \rightarrow vs. \rightarrow
- $b \rightarrow \{b\}$ $a \rightarrow \{\}$
- $aaaaa \rightarrow \{ac, aca, acab, acabc\}$

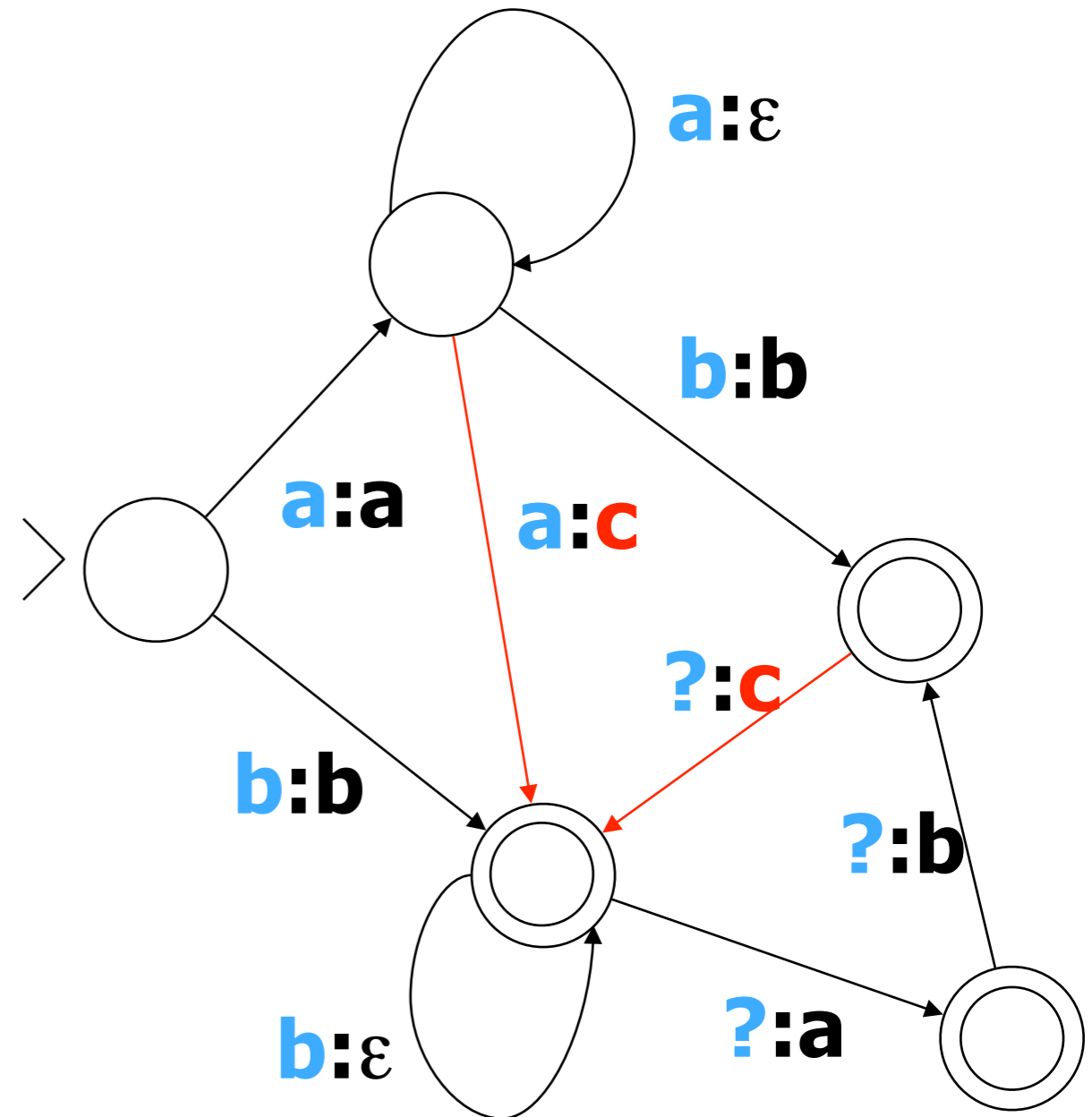

Regular Relation (of strings)

- Can weight the arcs: \rightarrow vs. \rightarrow

- $b \rightarrow \{b\}$ $a \rightarrow \{\}$

- $aaaaa \rightarrow \{ac, aca, acab, acabc\}$

- How to find best outputs?

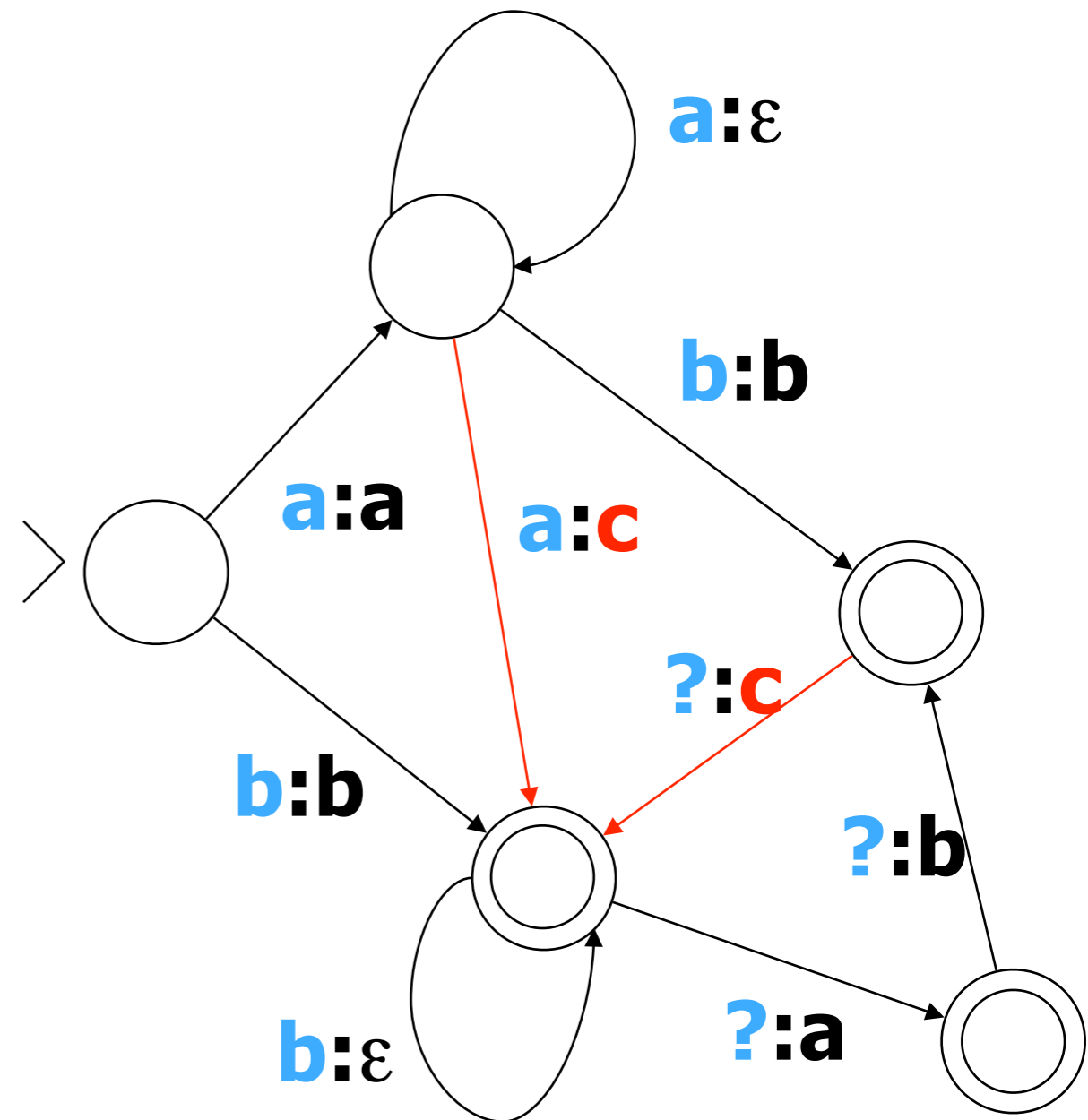

Function from strings to ...

Acceptors (FSAs)

Transducers (FSTs)

Unweighted

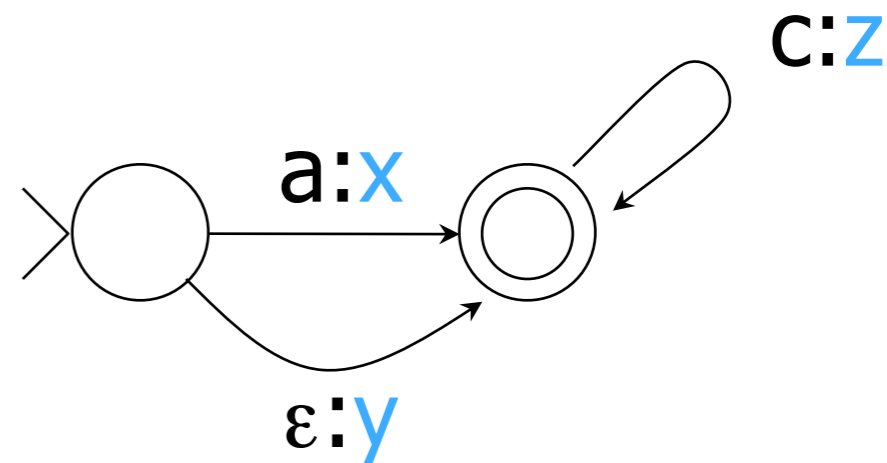
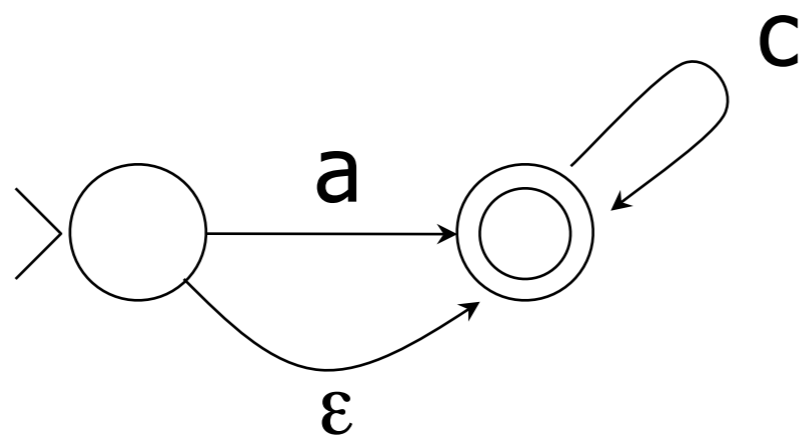

Weighted

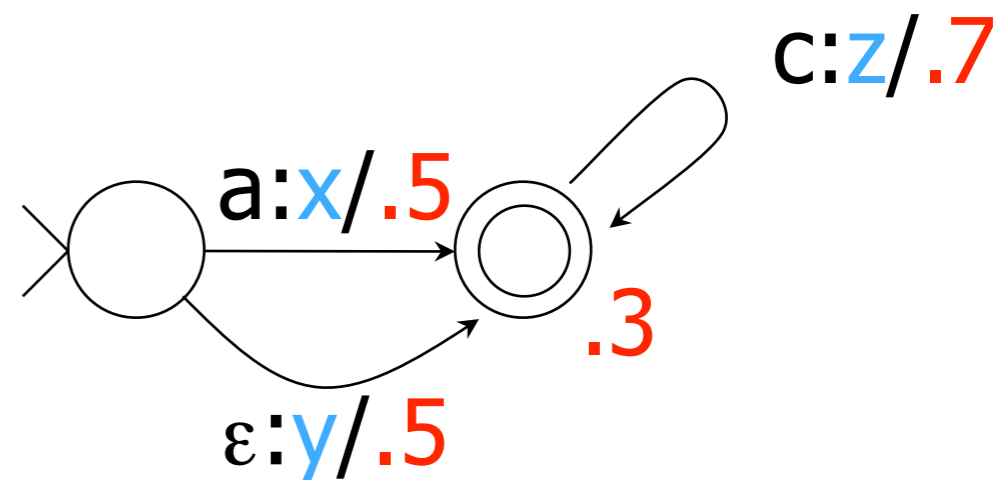
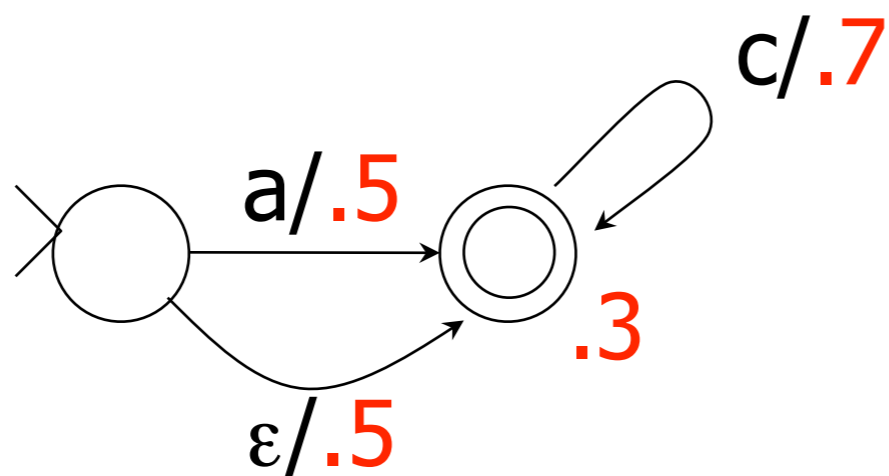

Function from strings to ...

Acceptors (FSAs)

Transducers (FSTs)

Unweighted

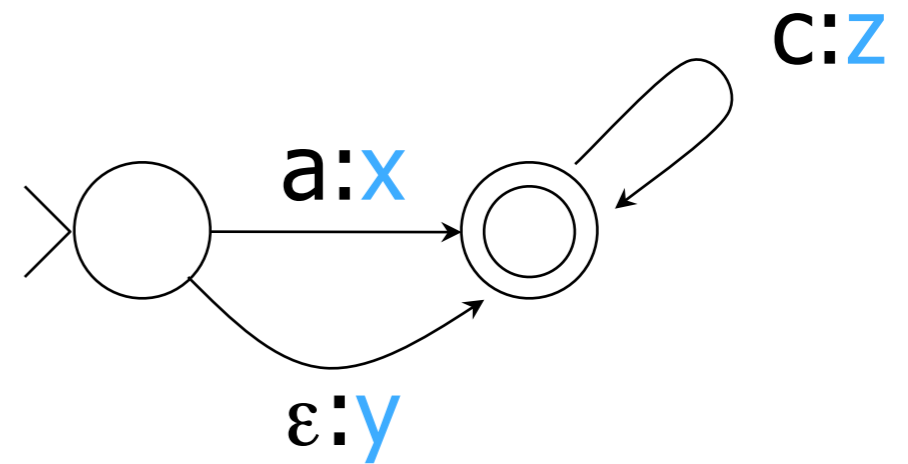
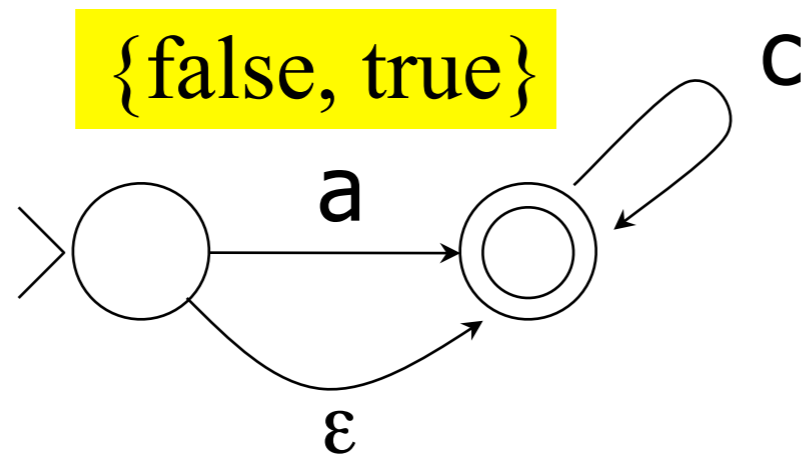

Weighted

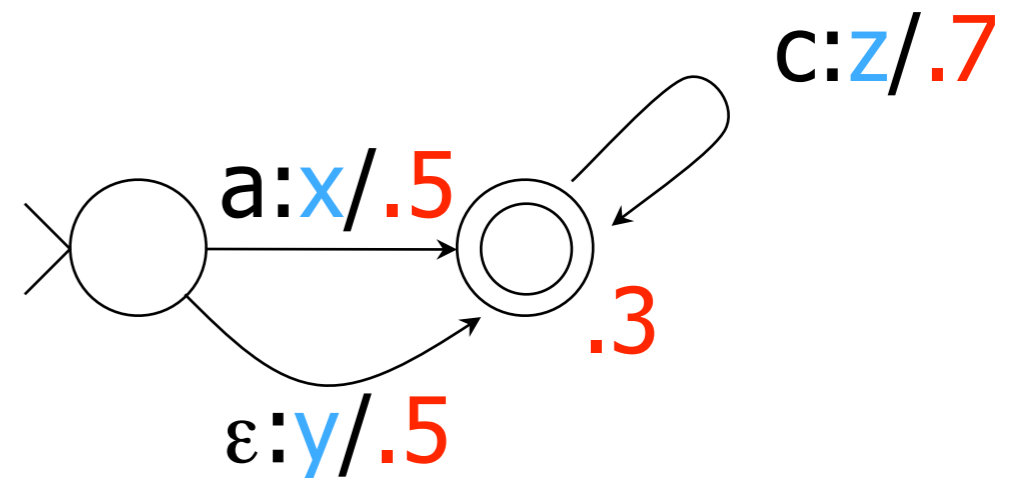
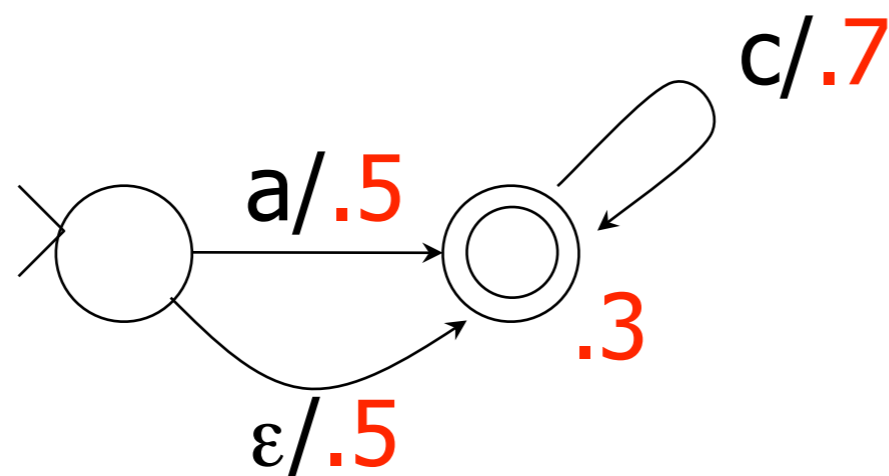

Function from strings to ...

Acceptors (FSAs)

Transducers (FSTs)

Unweighted

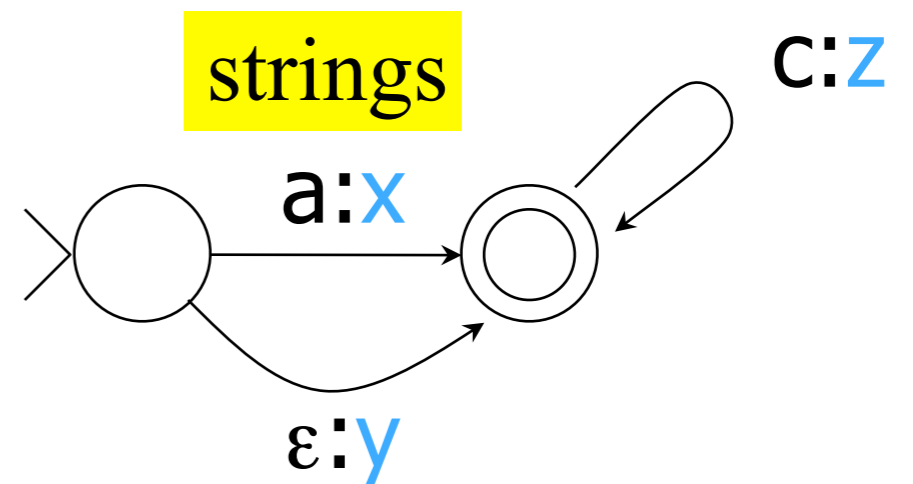
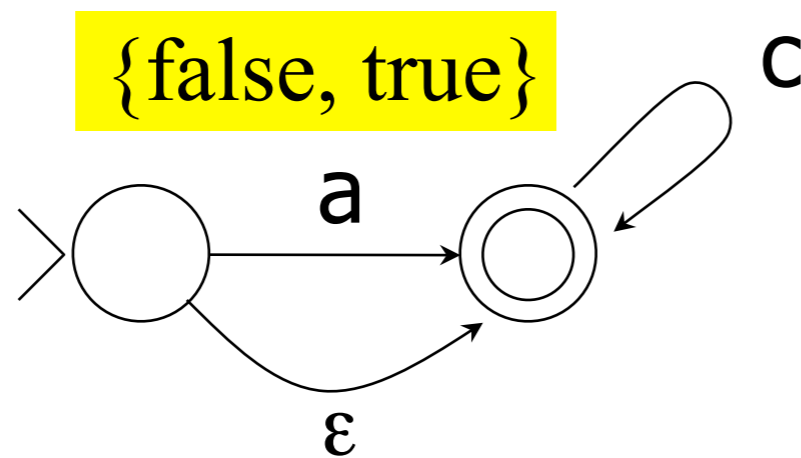

Weighted

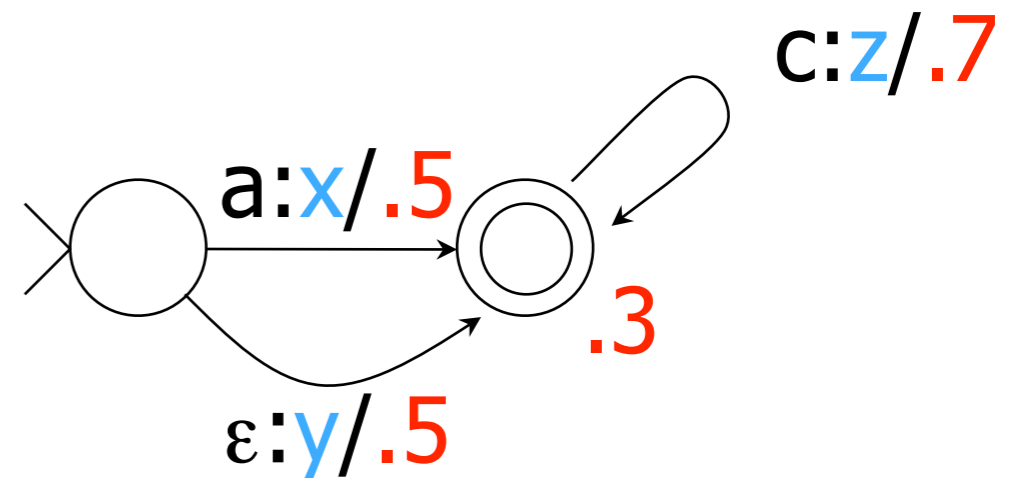
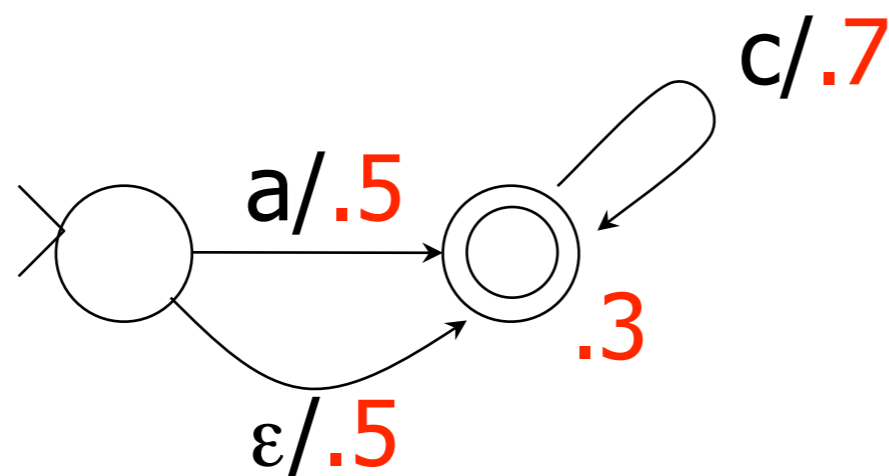

Function from strings to ...

Acceptors (FSAs)

Transducers (FSTs)

Unweighted

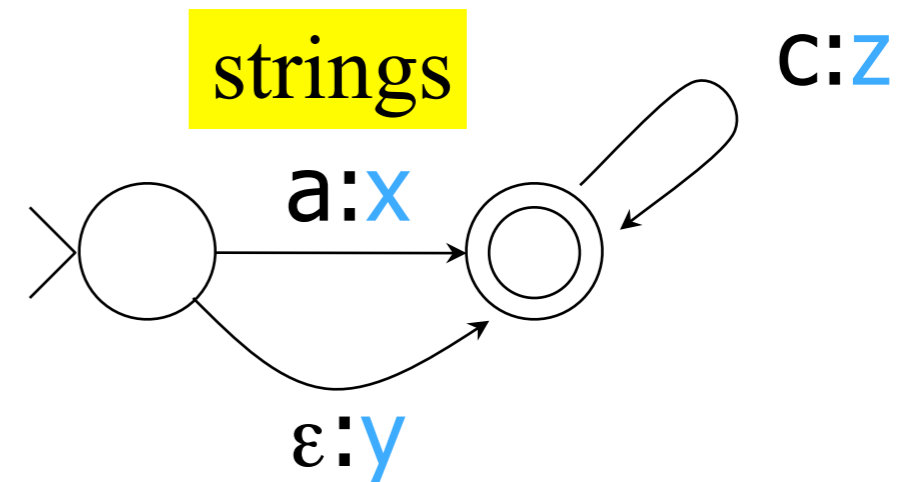
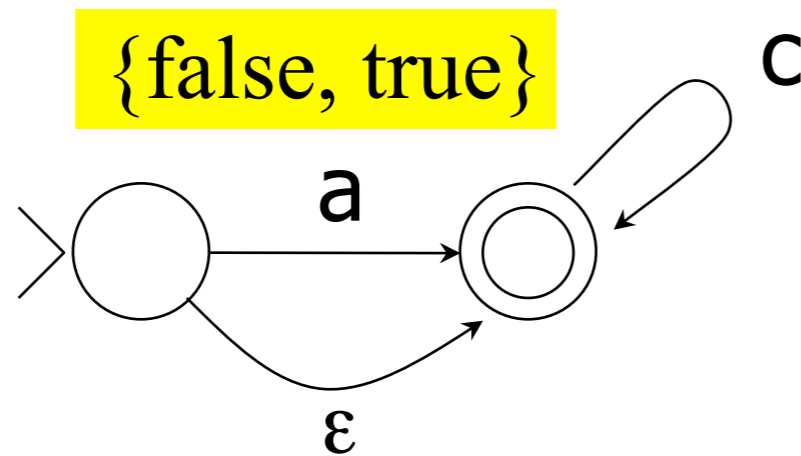

Weighted

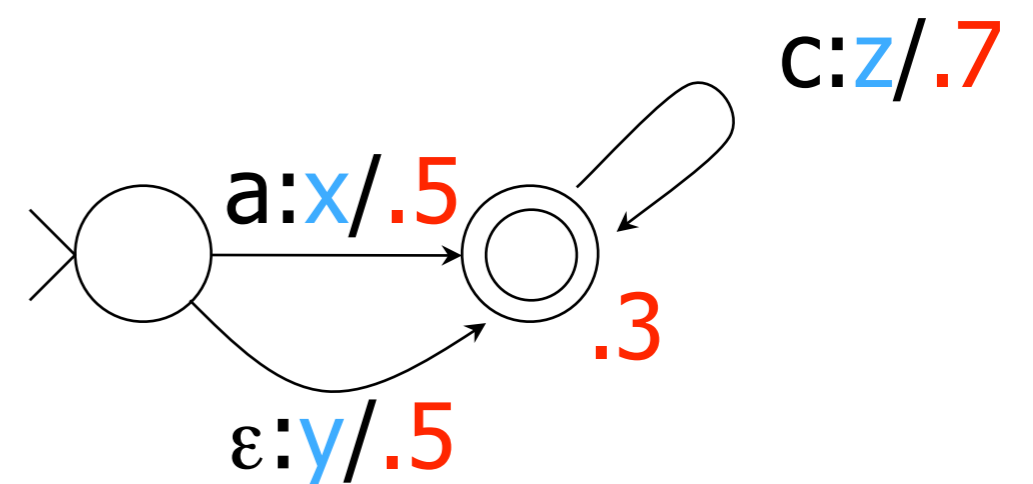
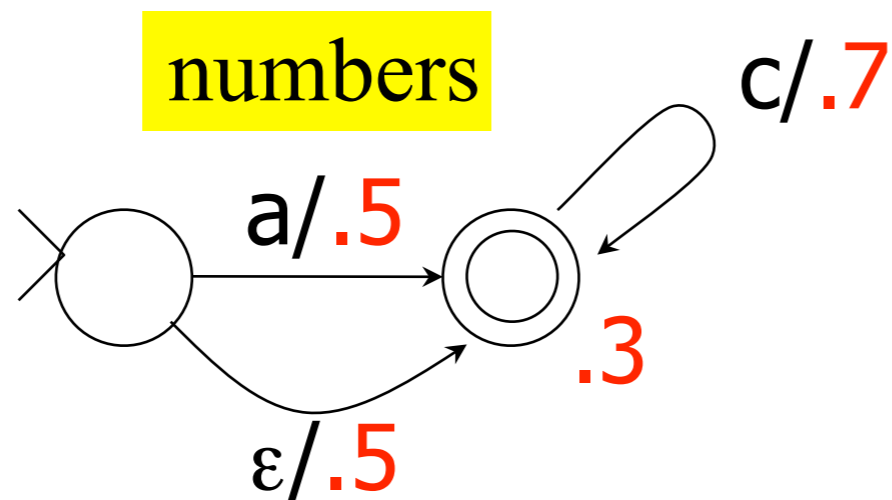

Function from strings to ...

Acceptors (FSAs)

Transducers (FSTs)

Unweighted

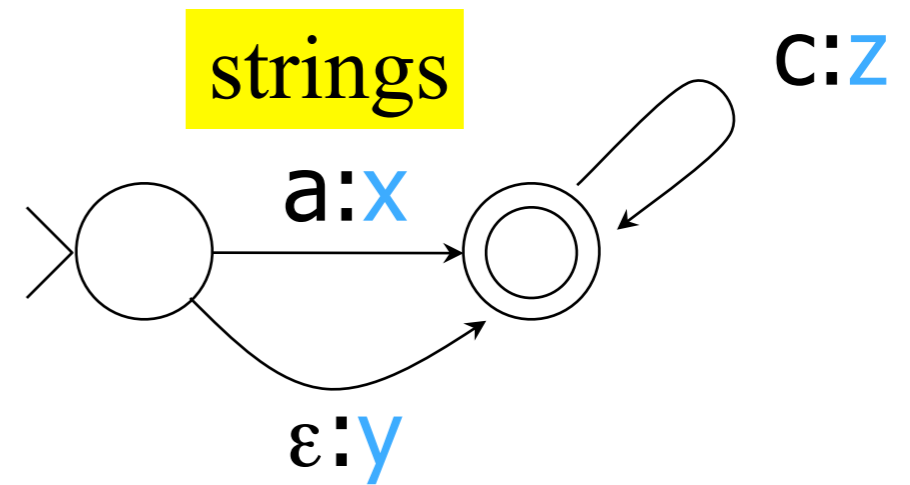
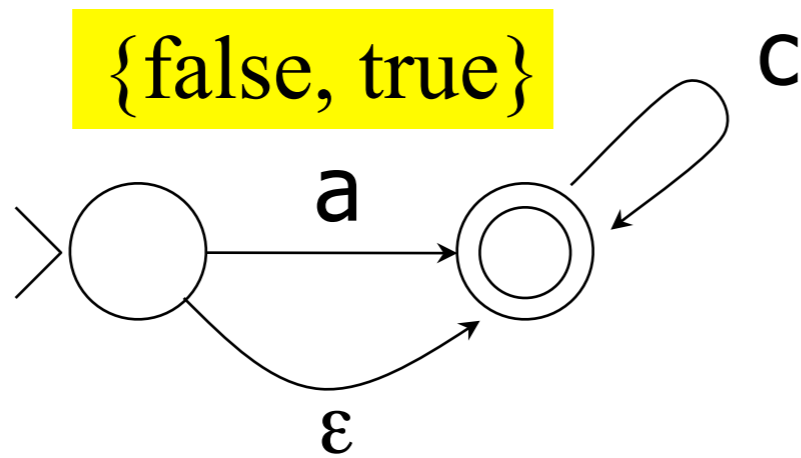

Weighted

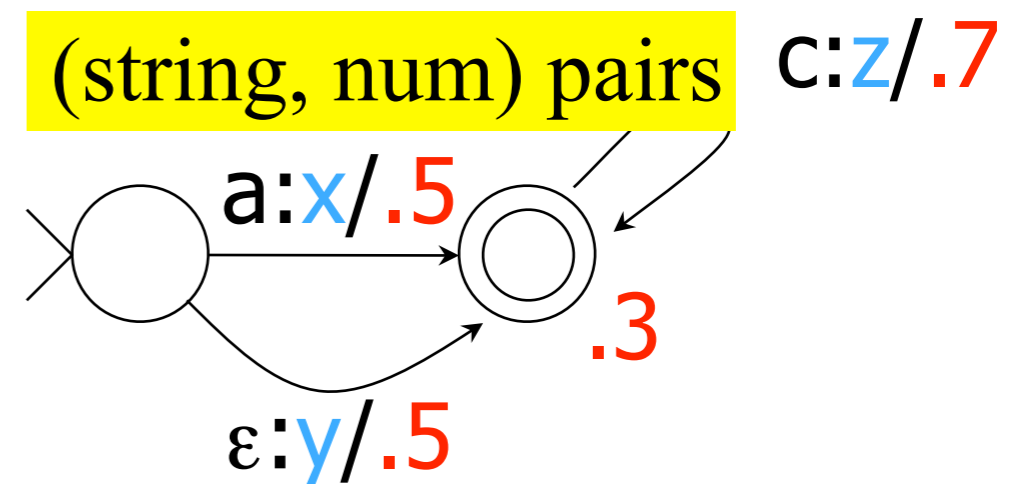
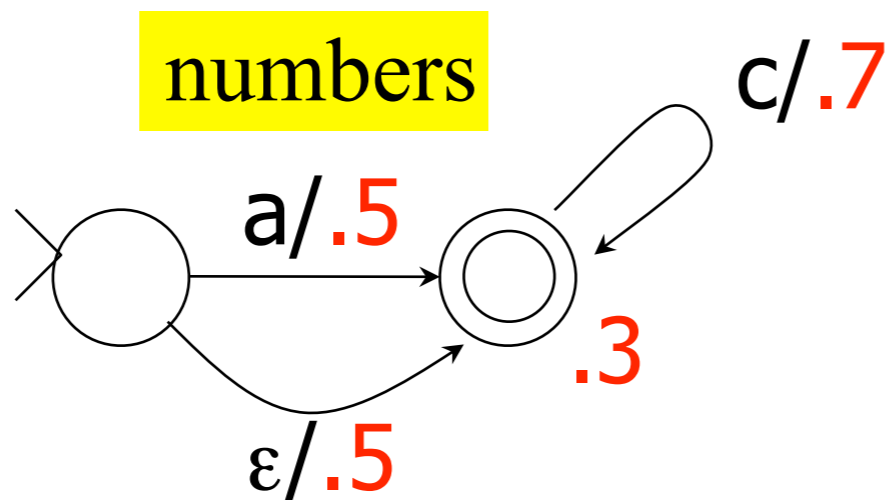

Sample functions

Acceptors (FSAs)

{false, true}

Unweighted

numbers

Weighted

Transducers (FSTs)

strings

(string, num) pairs

Sample functions

Acceptors (FSAs)

Transducers (FSTs)

{false, true}

strings

Unweighted

Grammatical?

numbers

(string, num) pairs

Weighted

Sample functions

Acceptors (FSAs)

Transducers (FSTs)

Unweighted

{false, true}

strings

Grammatical?

numbers

(string, num) pairs

Weighted

How grammatical?
Better, how likely?

Sample functions

Acceptors (FSAs)

Transducers (FSTs)

Unweighted

{false, true}

Grammatical?

strings

Markup
Correction
Translation

numbers

How grammatical?
Better, how likely?

(string, num) pairs

Weighted

Sample functions

Acceptors (FSAs)

Transducers (FSTs)

Unweighted

{false, true}

Grammatical?

strings

Markup
Correction
Translation

Weighted

numbers

How grammatical?
Better, how likely?

(string, num) pairs

Good markups
Good corrections
Good translations

Terminology (acceptors)

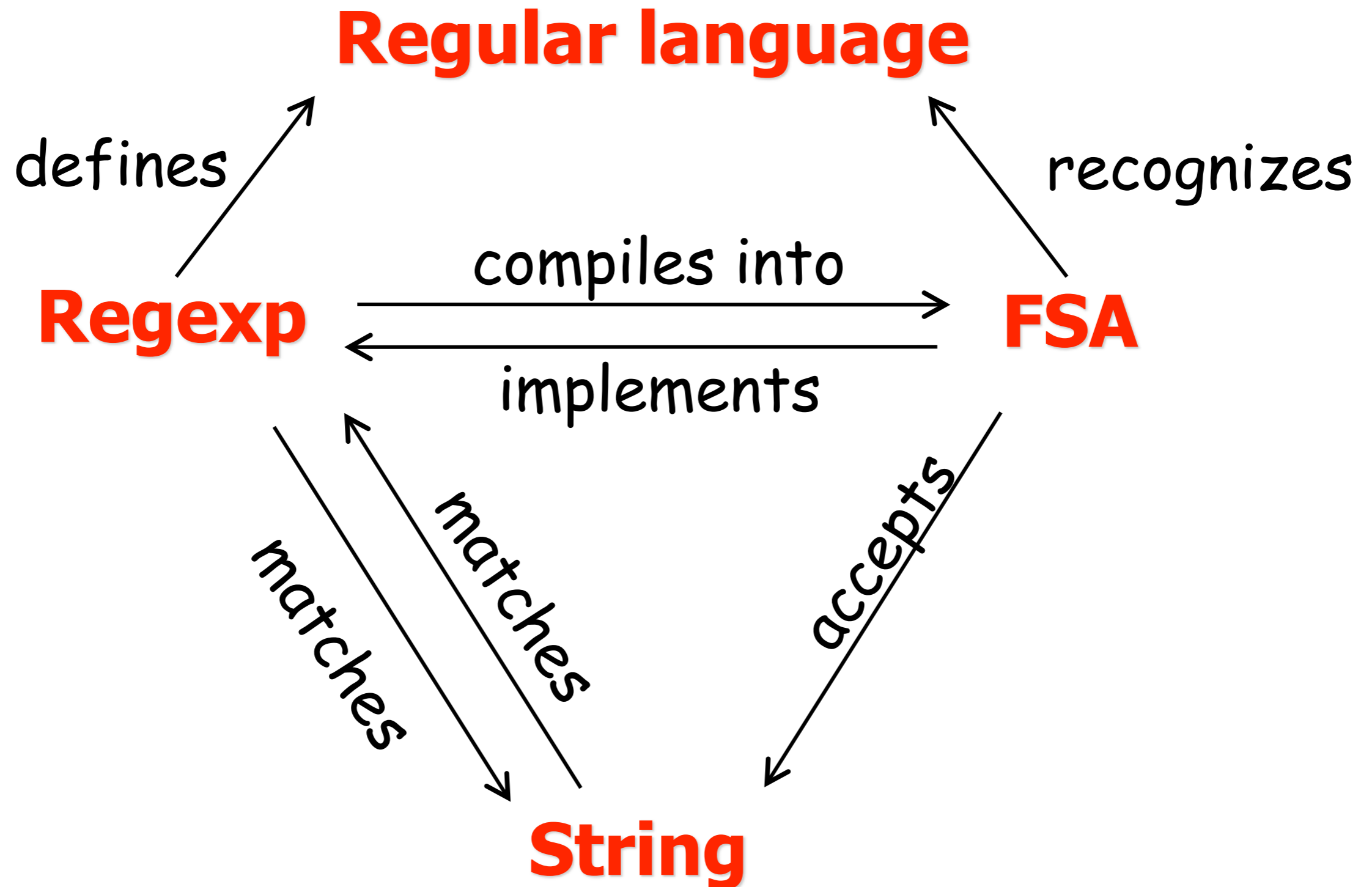

Terminology (acceptors)

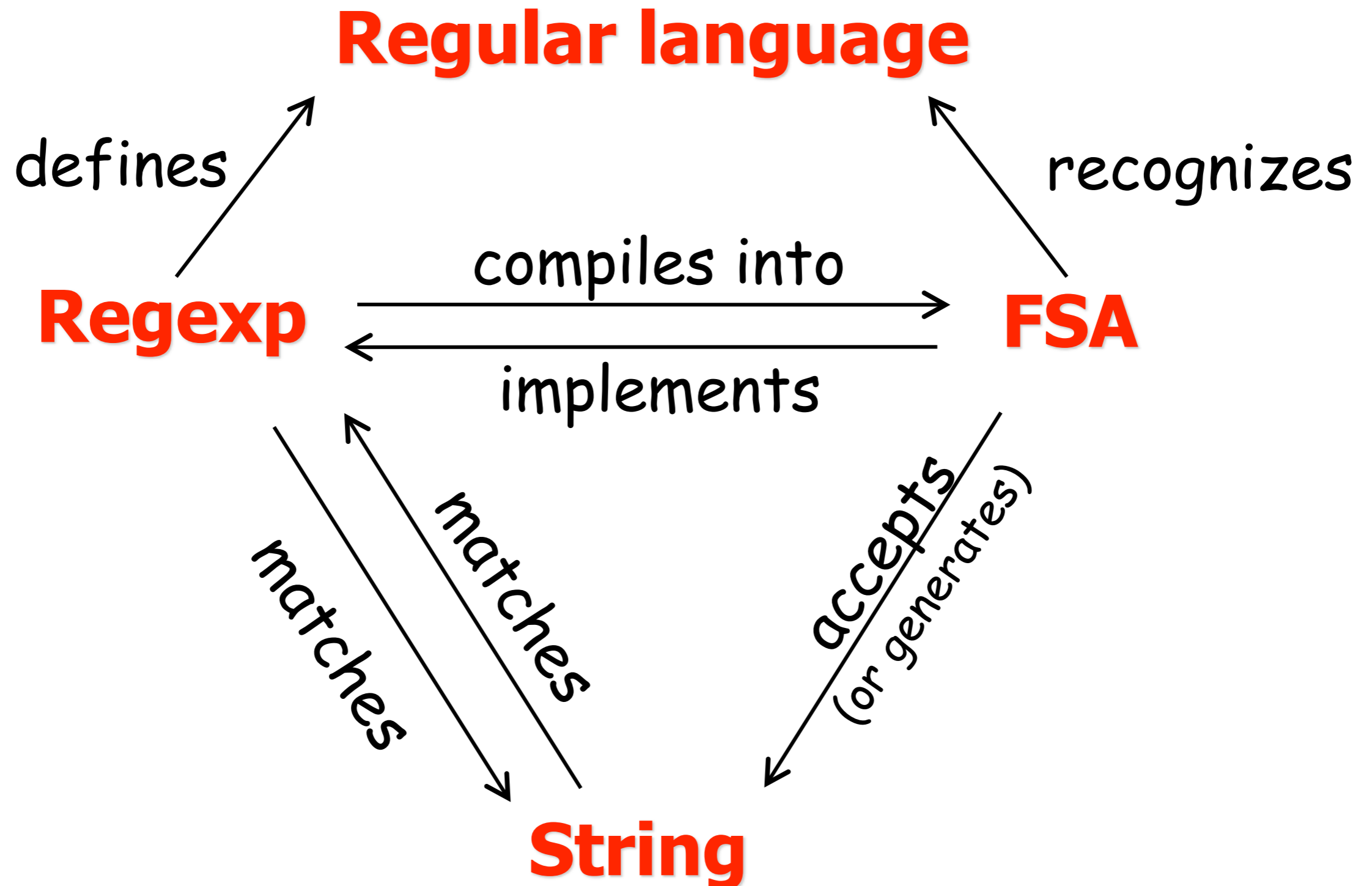

Terminology (transducers)

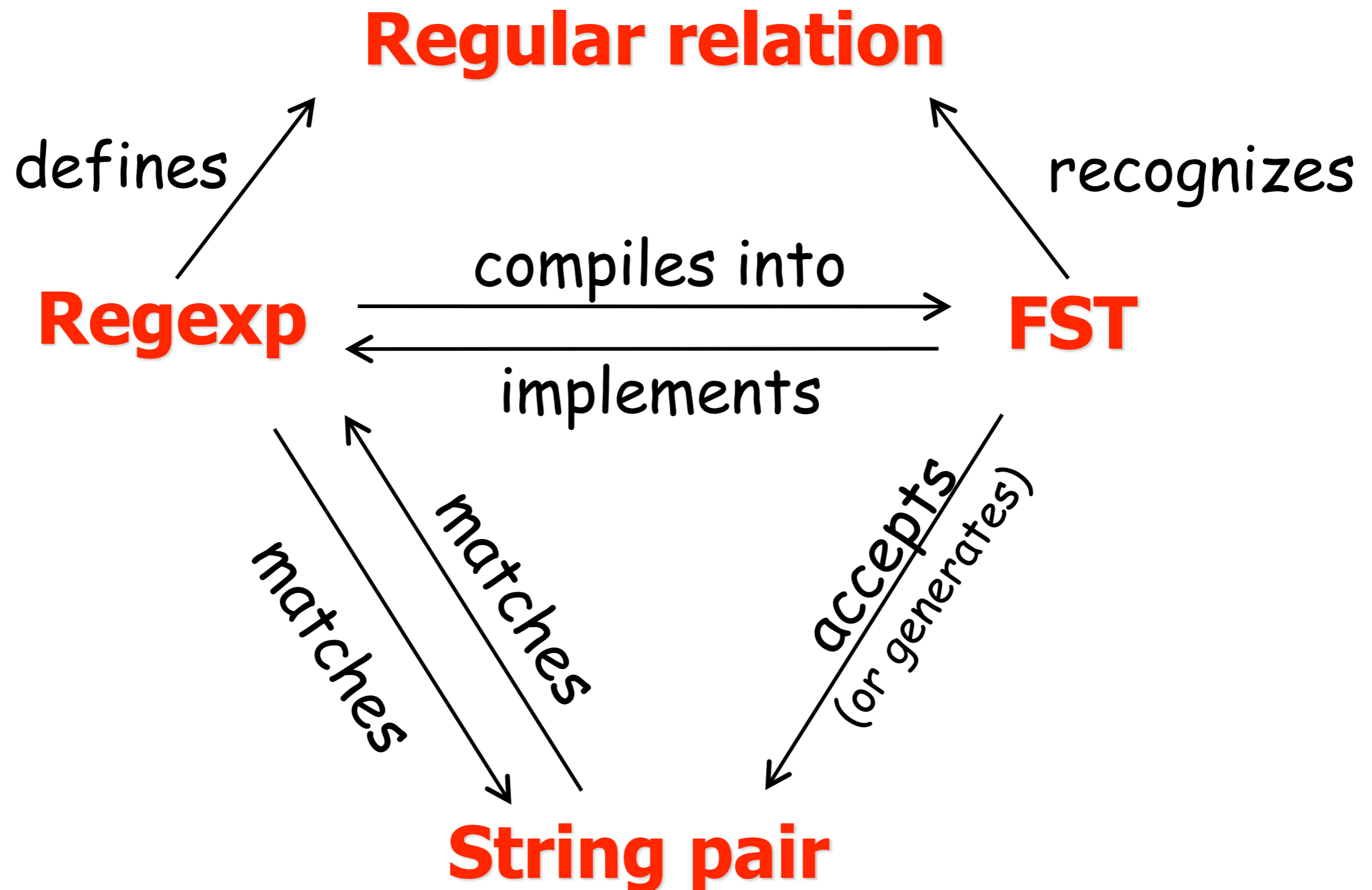

Terminology (transducers)

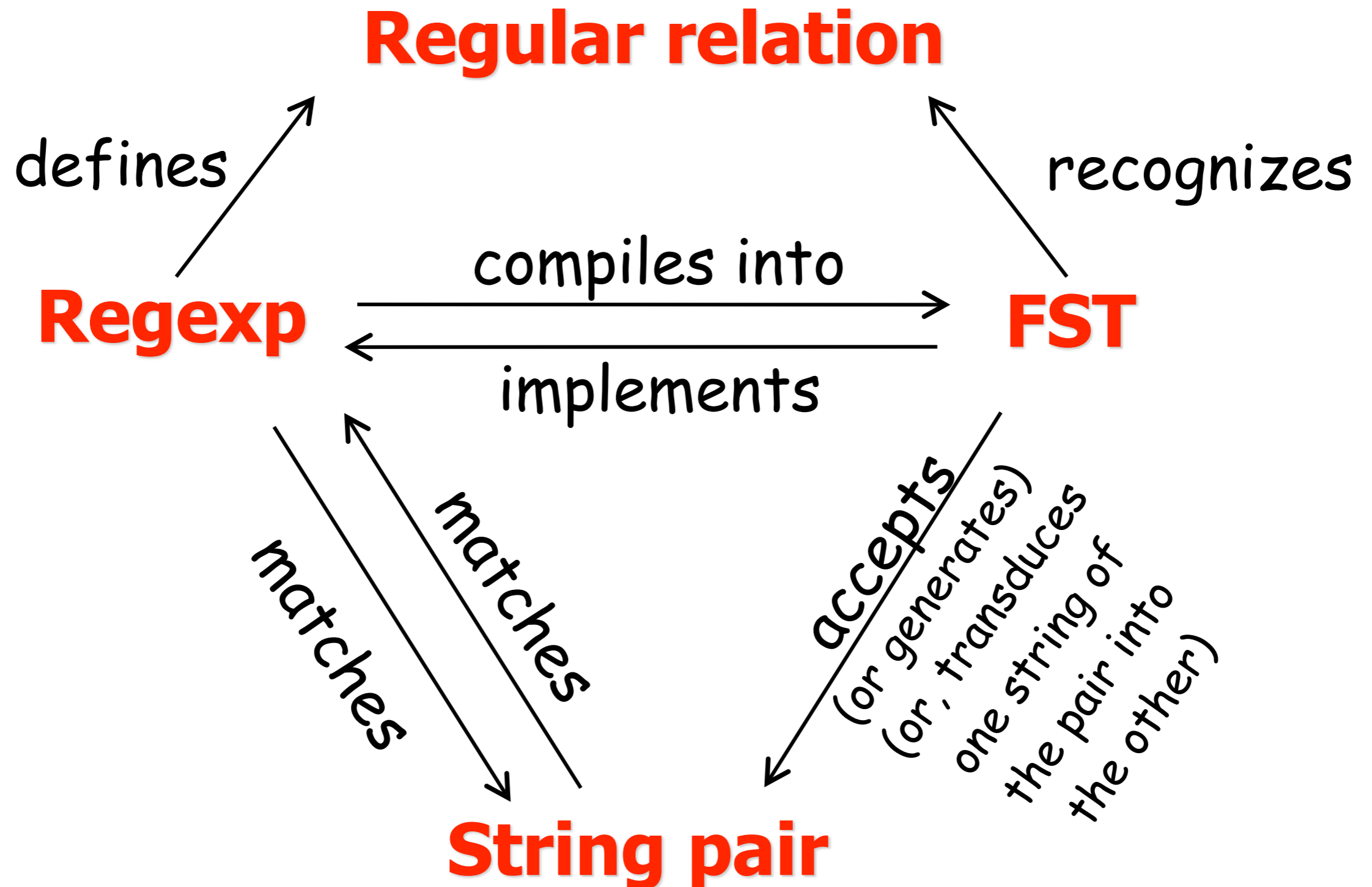

Terminology (transducers)

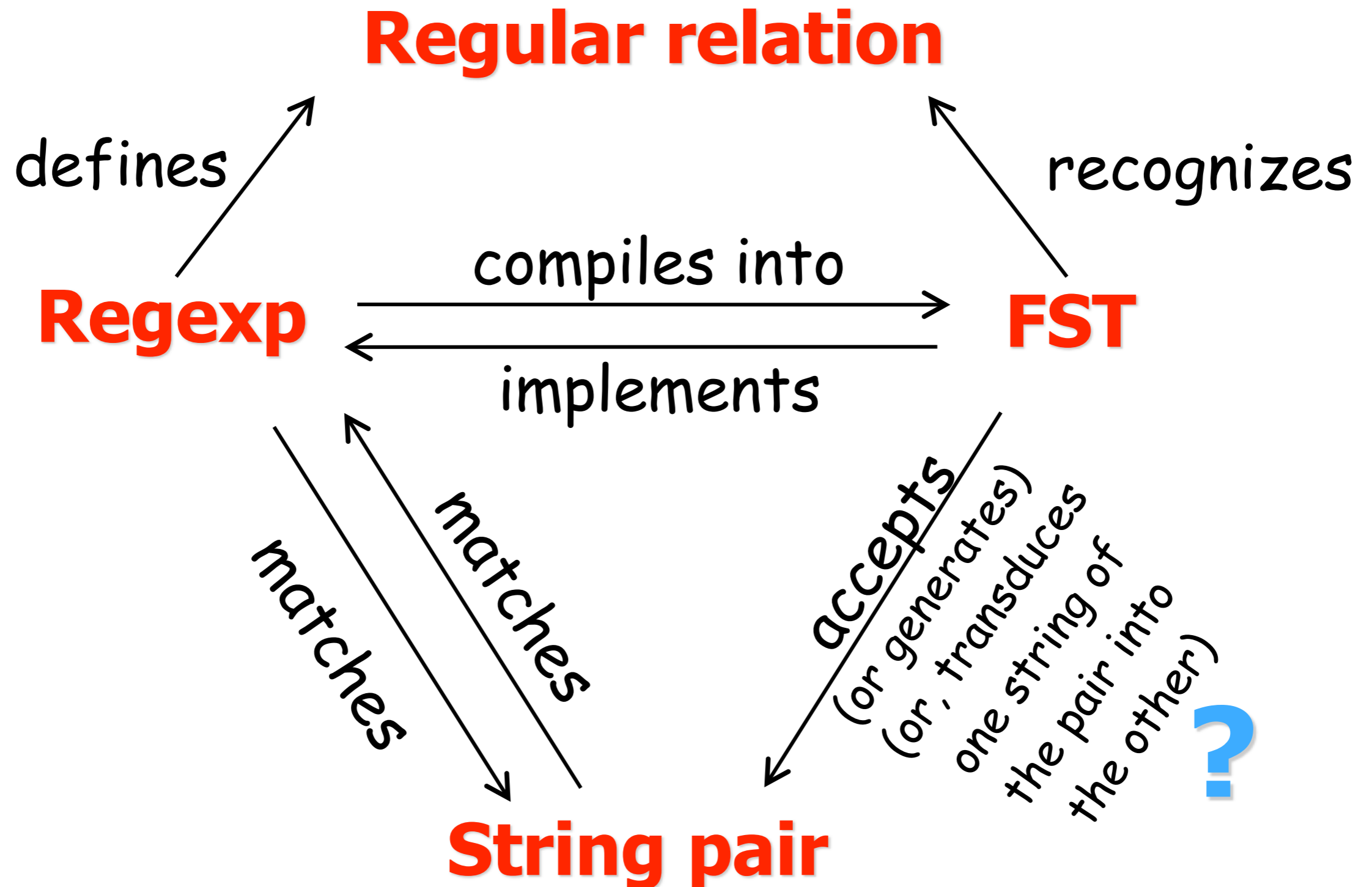

Perspectives on a Transducer

- Given **0** strings, **generate** a new string pair (by picking a path)
- Given **one** string (upper or lower), **transduce** it to the other kind
- Given **two** strings (upper & lower), **decide** whether to accept the pair

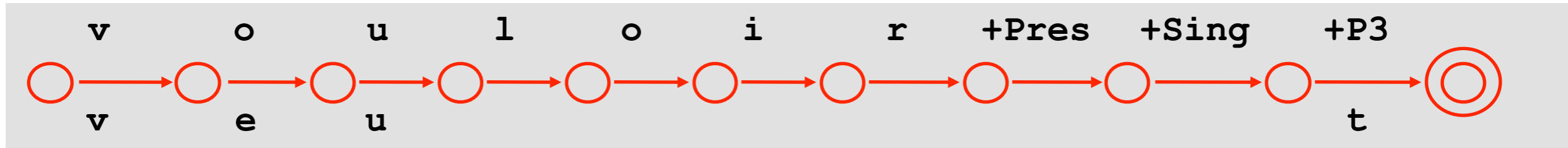

FST just defines the regular relation (mathematical object: set of pairs).

What's "input" and "output" depends on what one asks about the relation.

The 0, 1, or 2 given string(s) constrain which paths you can use.

Functions

ab?d →

Functions

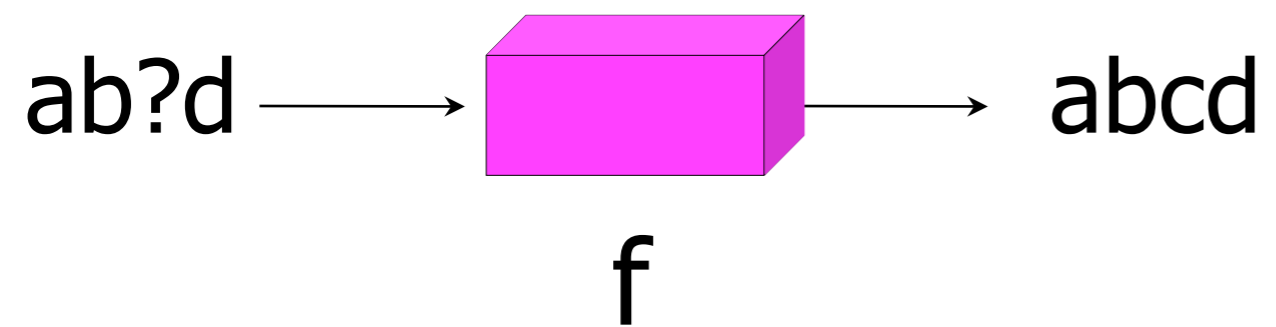

Functions

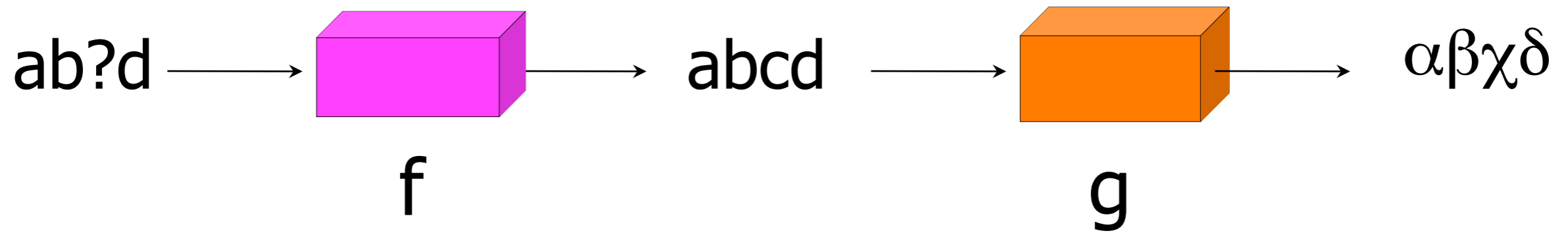

Functions



Function composition: $f \circ g$

Functions



Function composition: $f \circ g$

[first f , then g – intuitive notation, but opposite of the traditional math notation]

From Functions to Relations

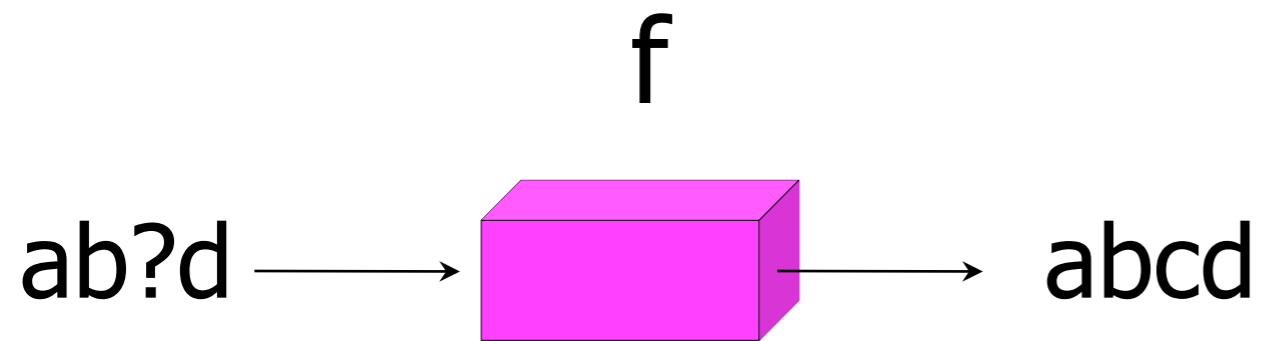

From Functions to Relations

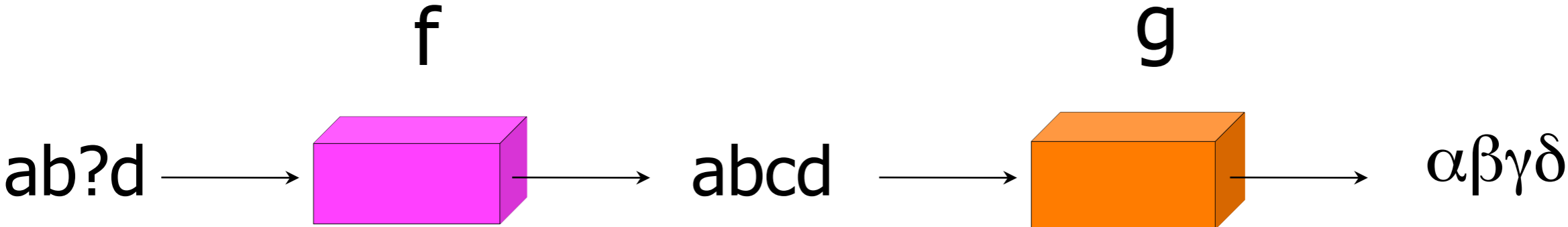

From Functions to Relations

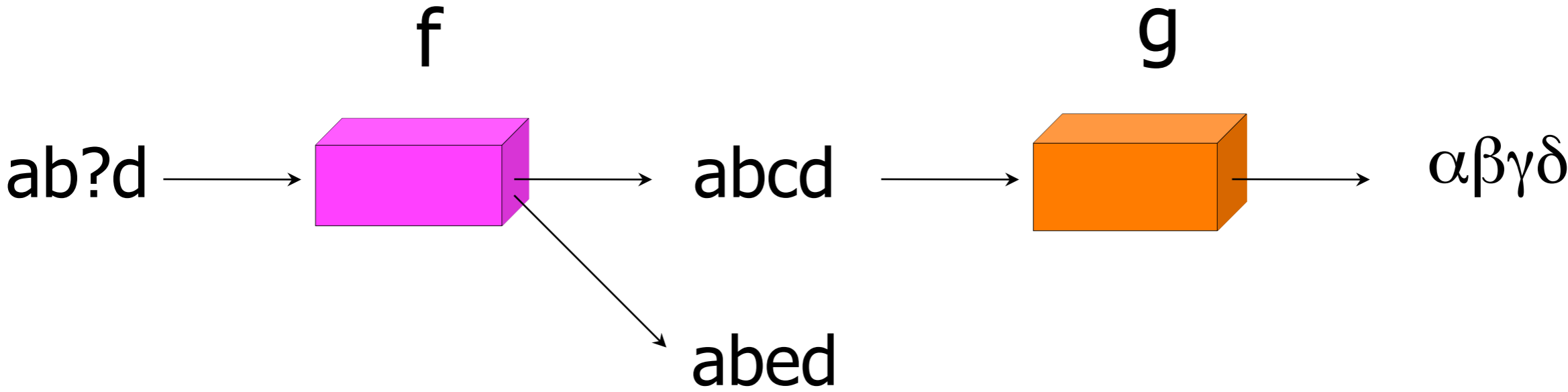

From Functions to Relations

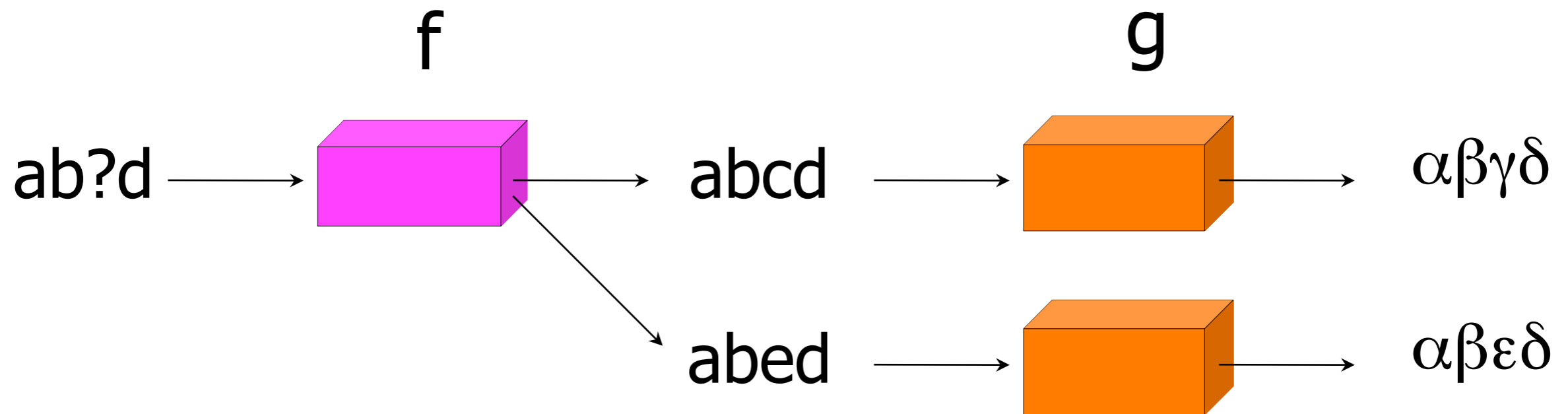

From Functions to Relations

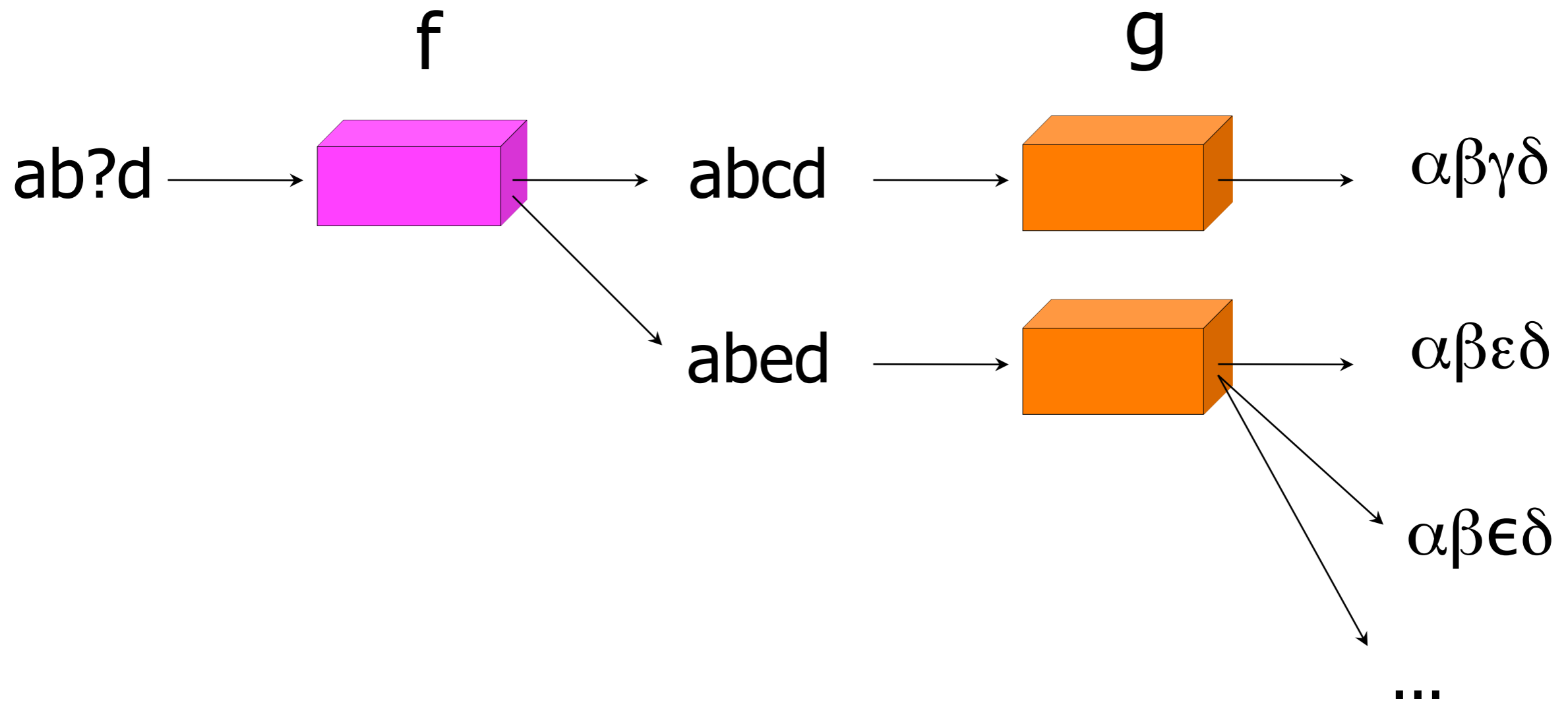

From Functions to Relations

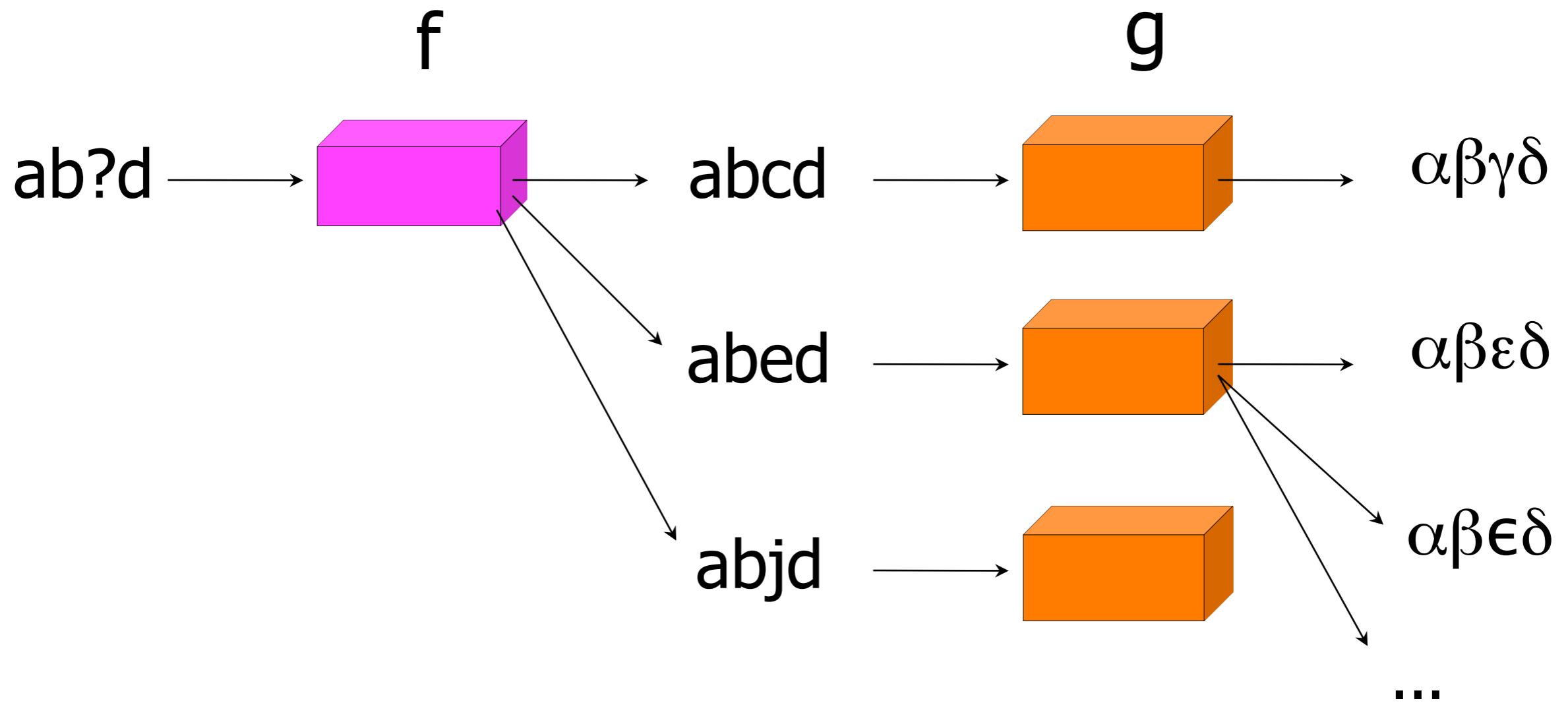

From Functions to Relations

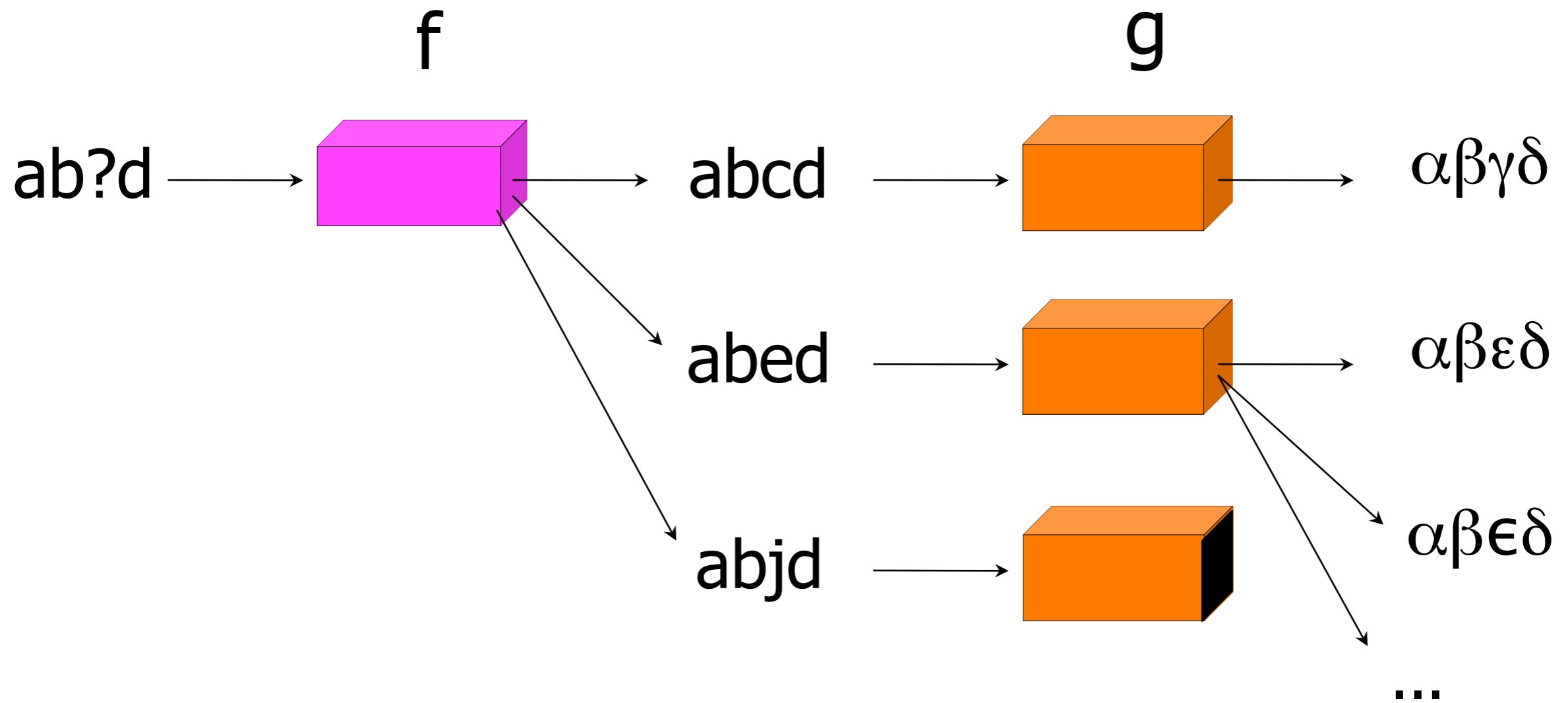

From Functions to Relations

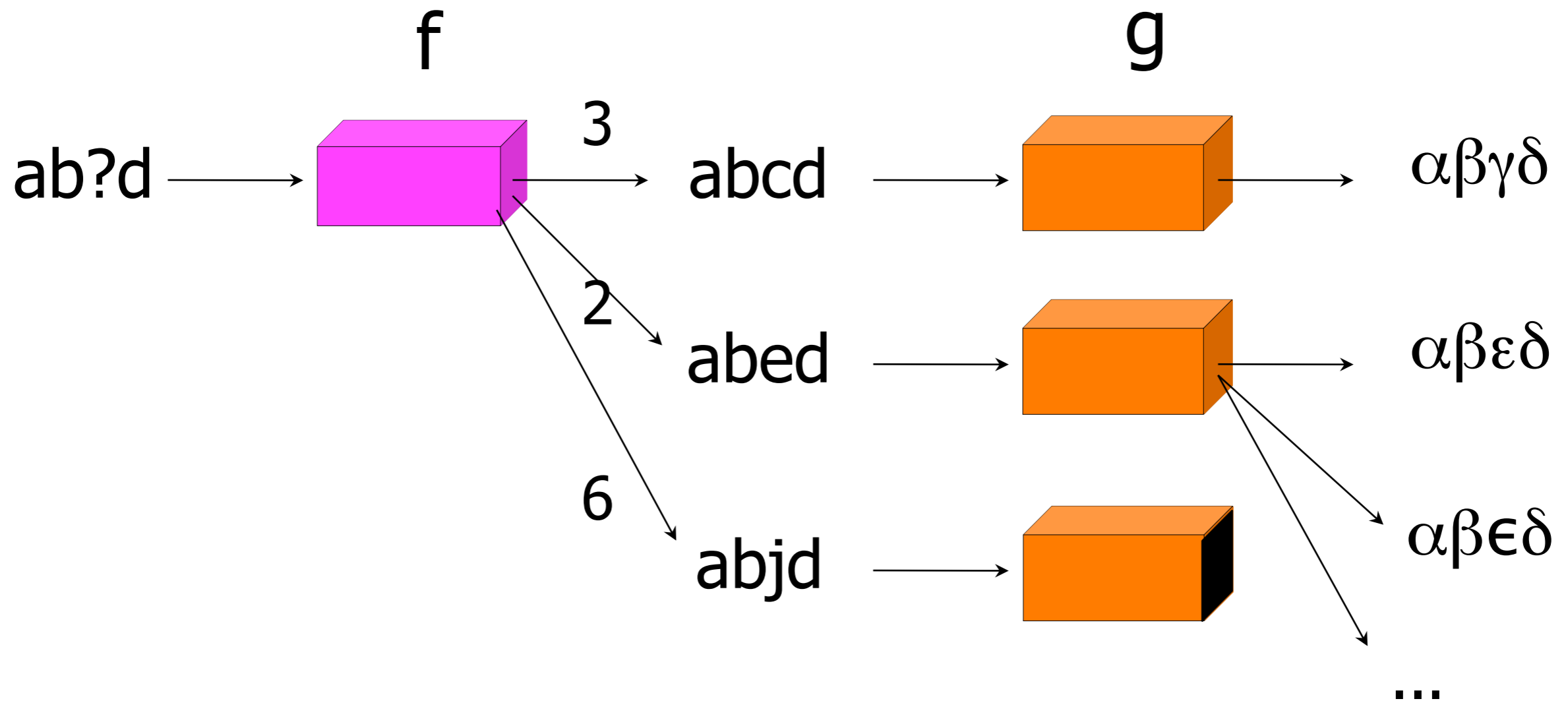

From Functions to Relations

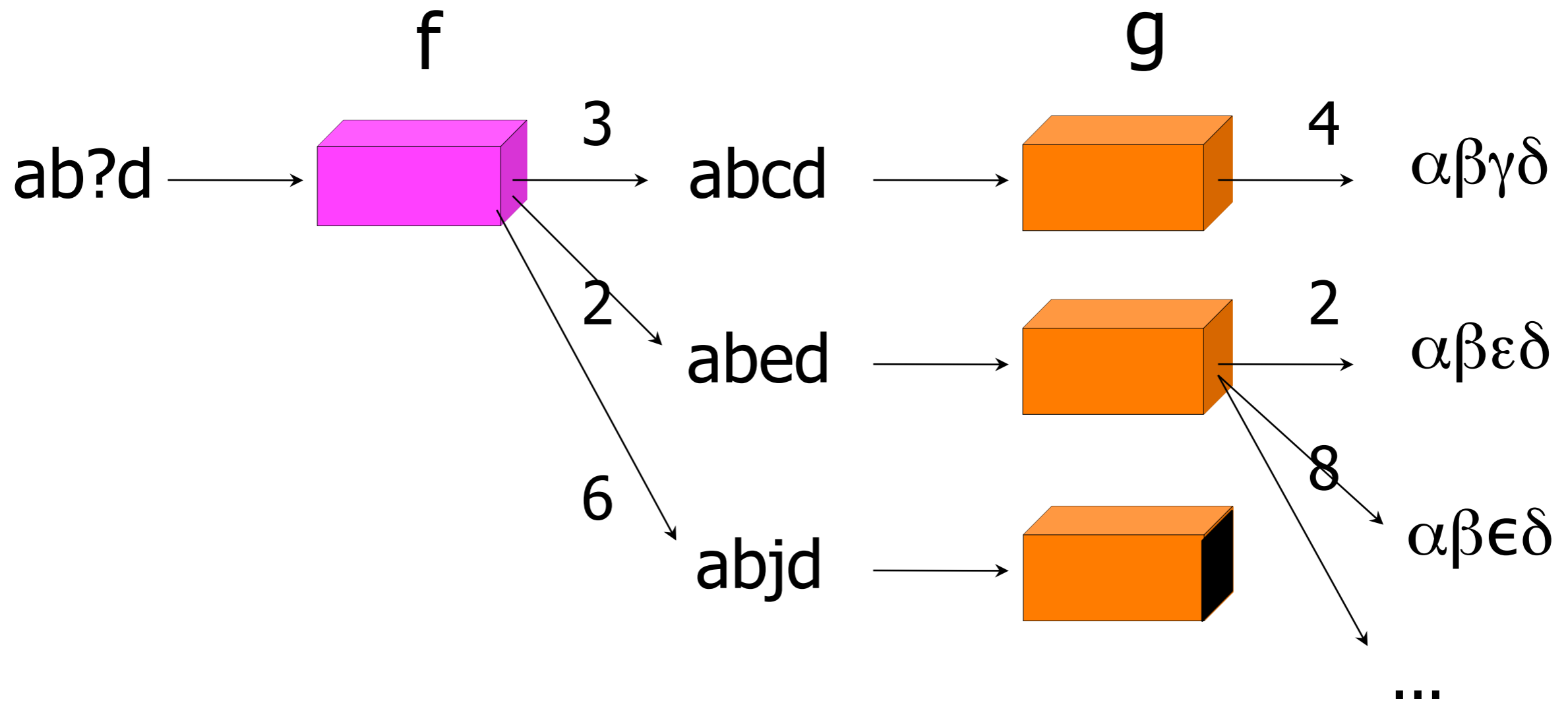

From Functions to Relations

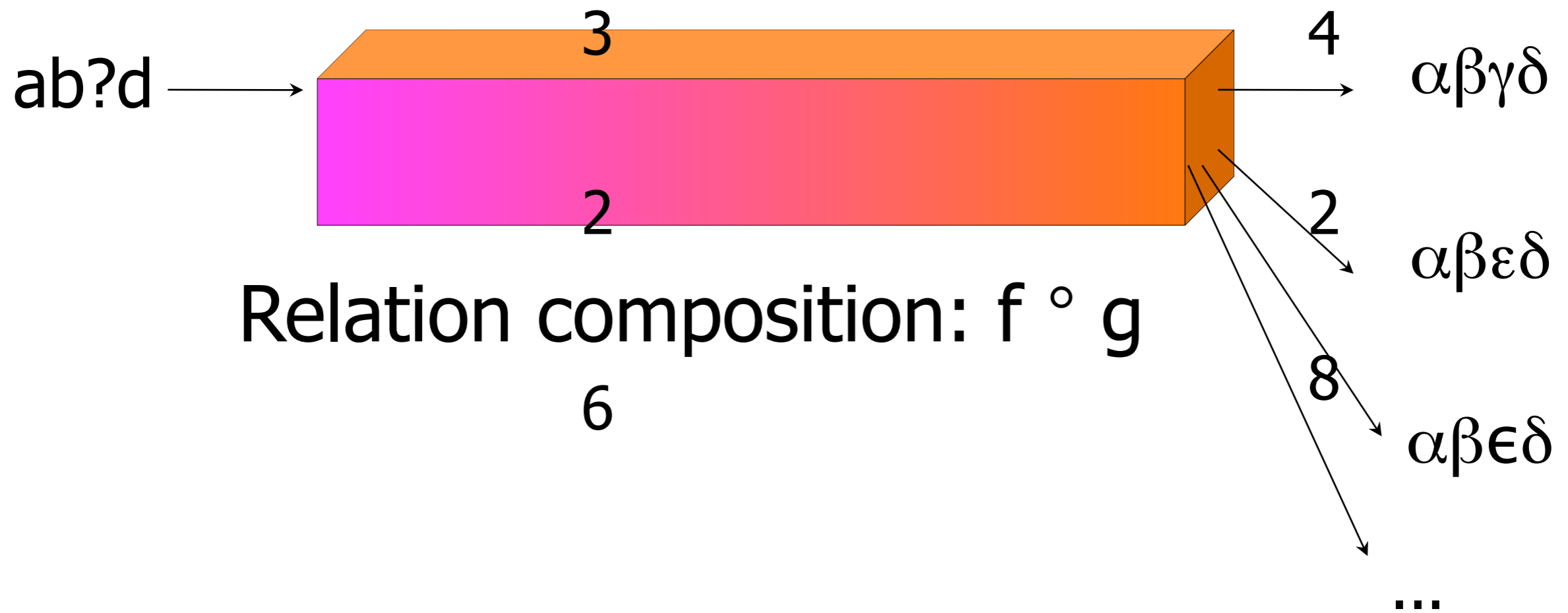

From Functions to Relations

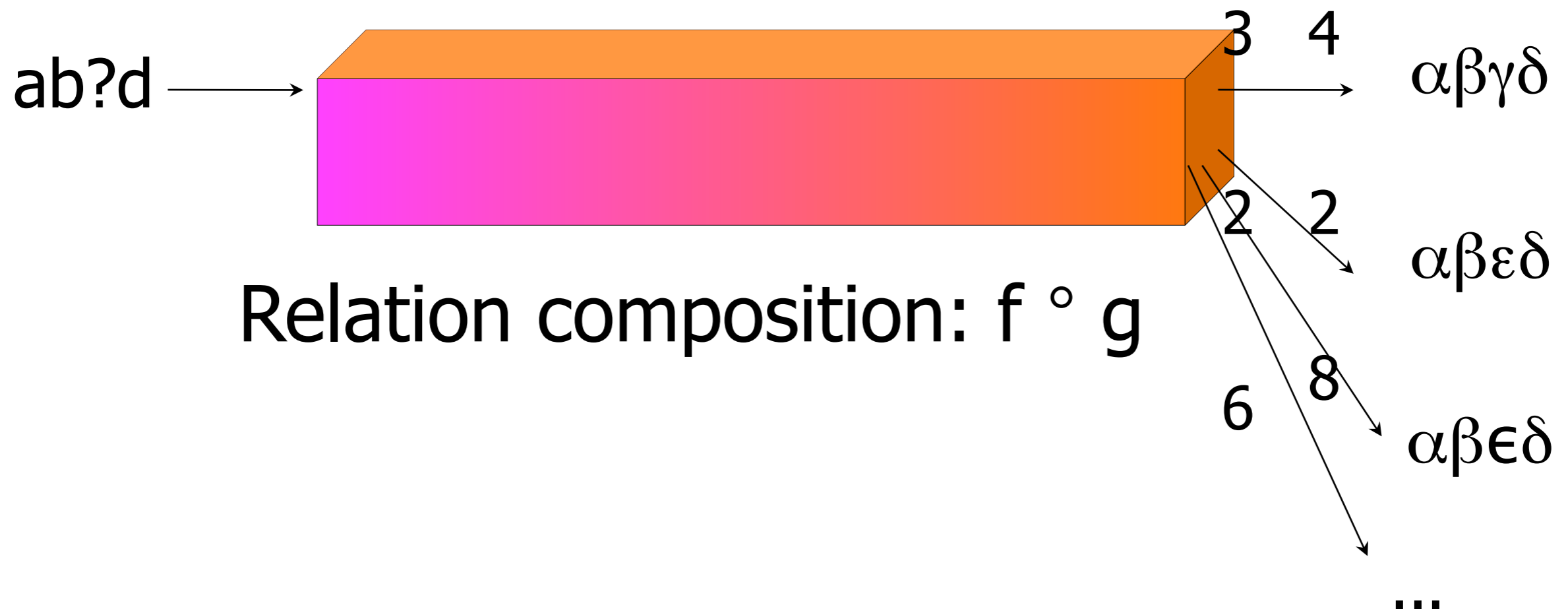

From Functions to Relations

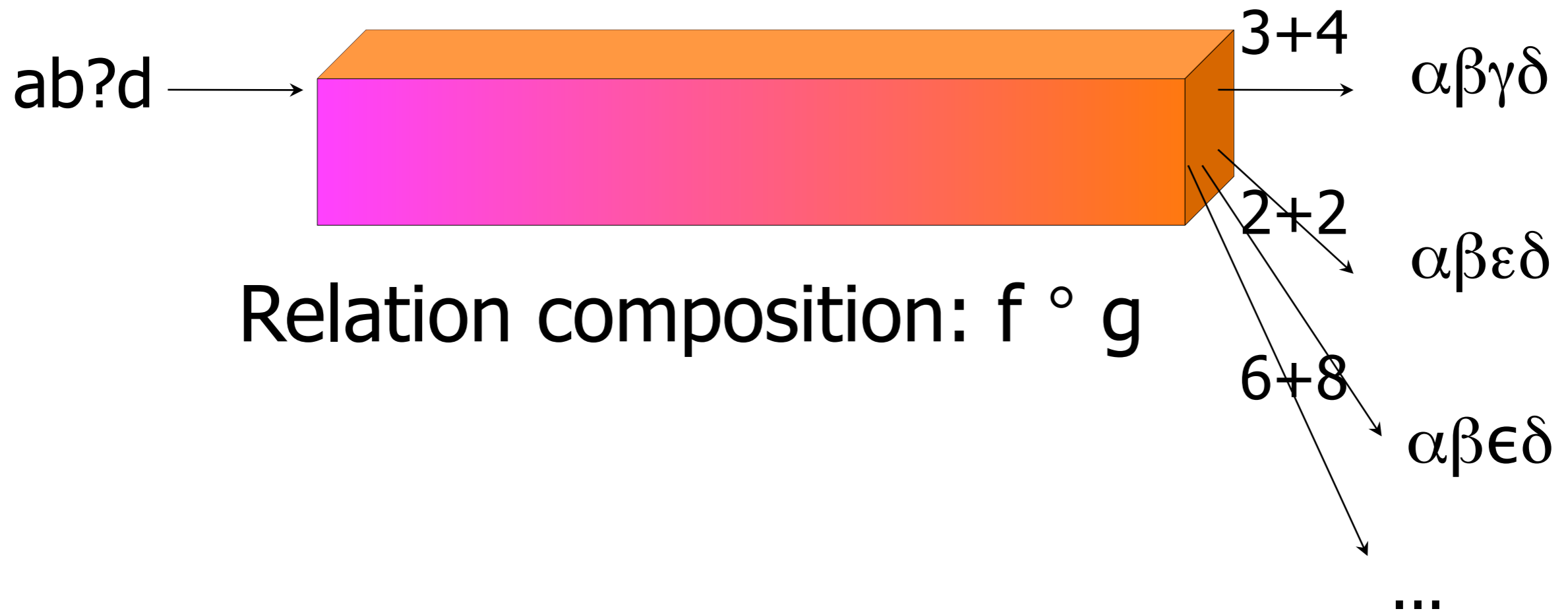

From Functions to Relations



From Functions to Relations

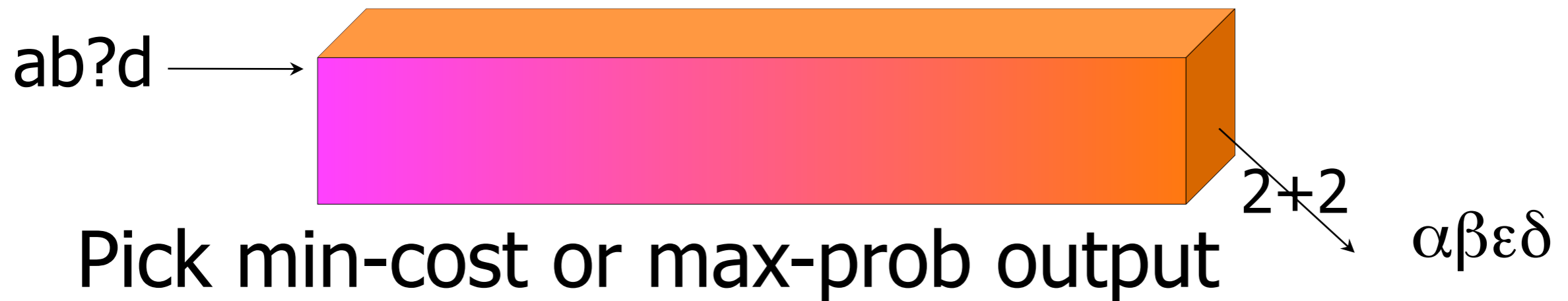

Often in NLP, all of the functions or relations involved can be described as finite-state machines, and manipulated using standard algorithms.

Inverting Relations

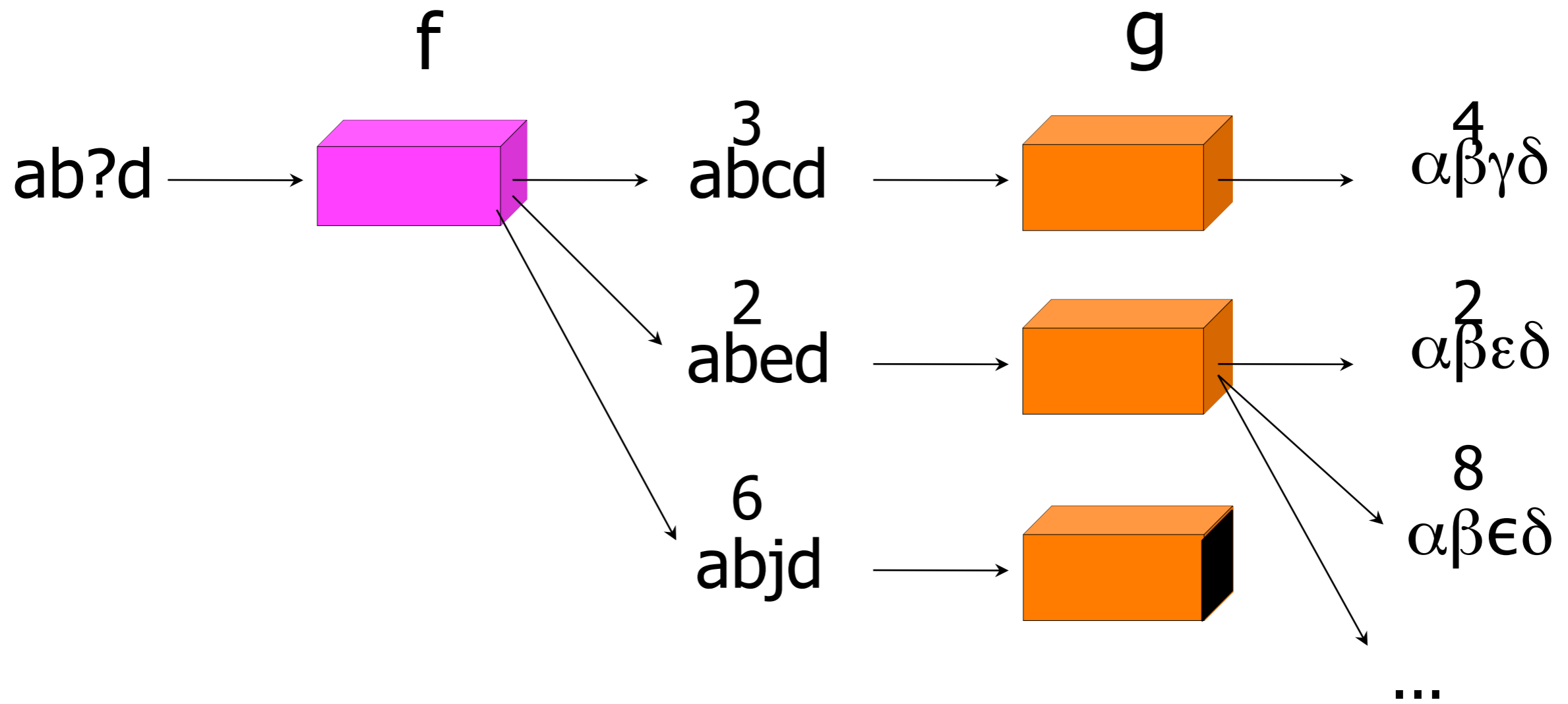

Inverting Relations

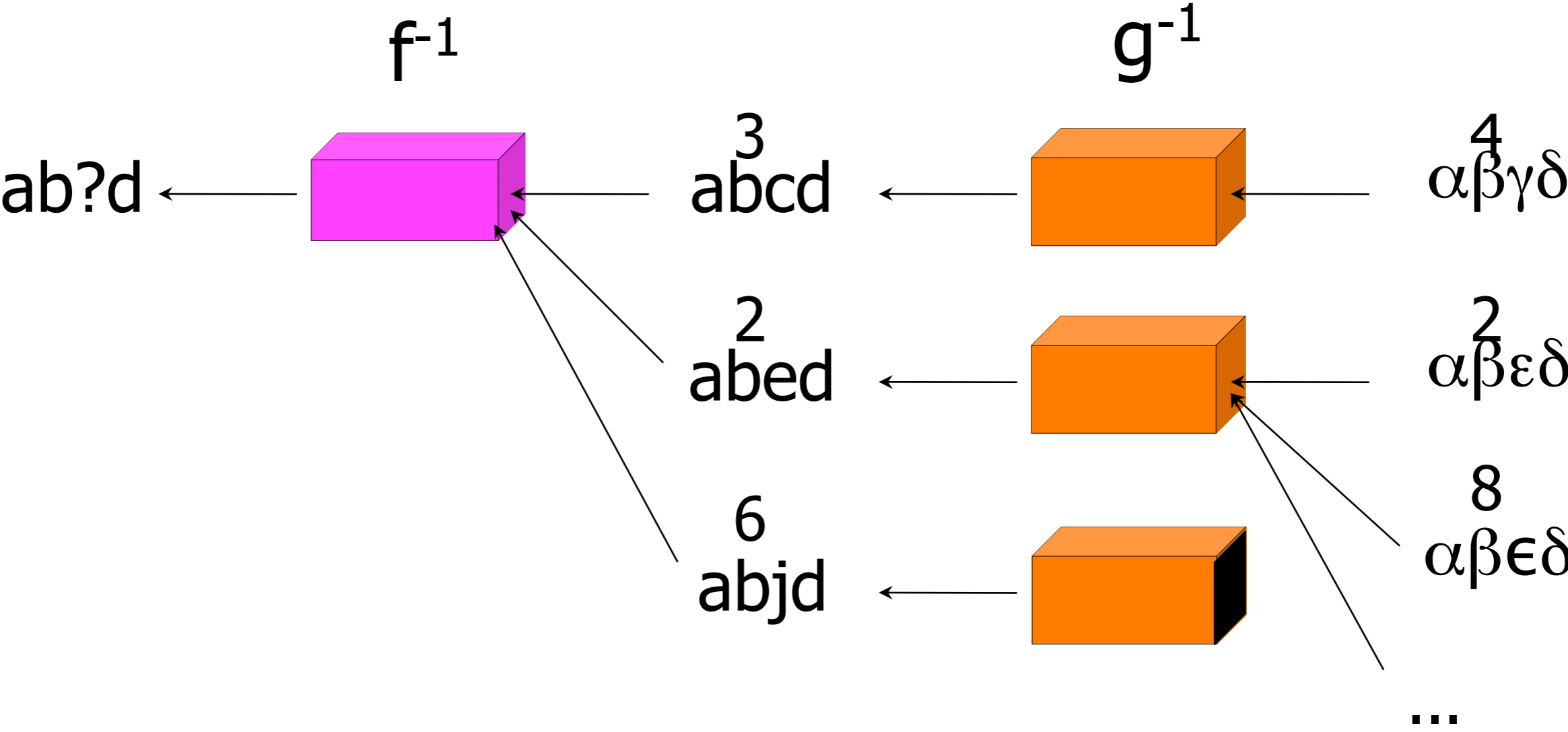

Inverting Relations

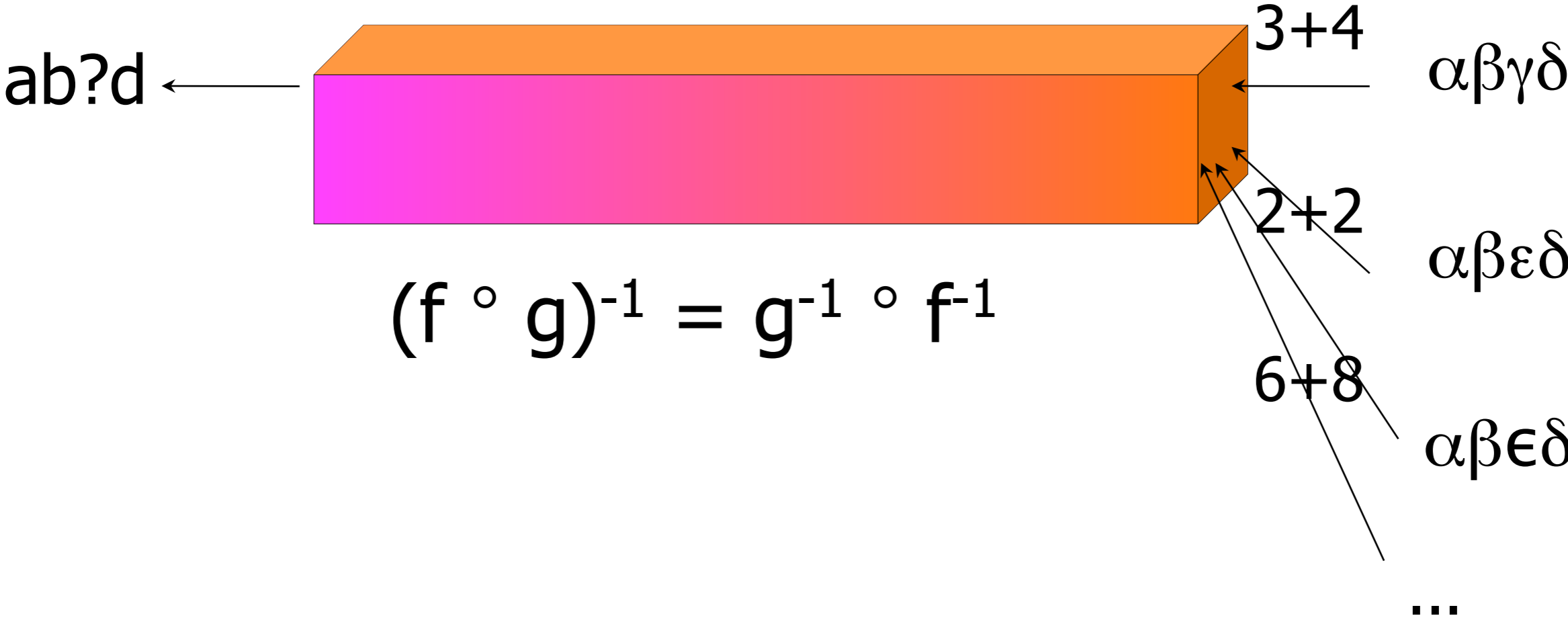

Building a lexical transducer

big | clear | clever | ear | fat | ...

Regular Expression
Lexicon

Building a lexical transducer

big | clear | clever | ear | fat | ...

Regular Expression
Lexicon

Compiler

Lexicon
FSA

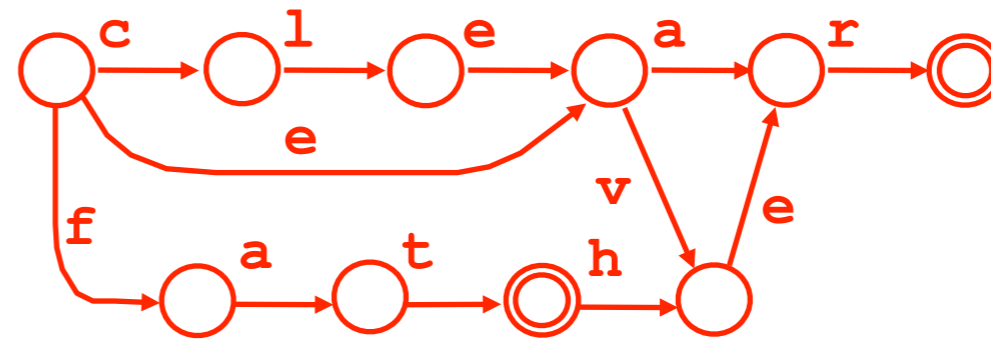

Building a lexical transducer

big | clear | clever | ear | fat | ...

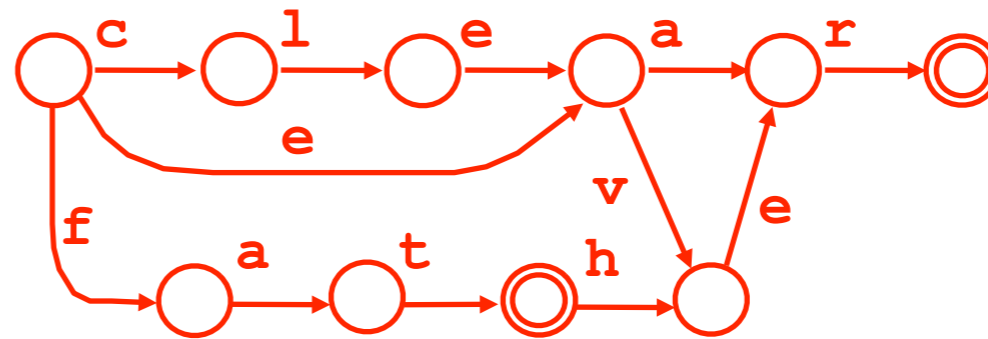

Regular Expression
Lexicon

Lexicon
FSA

Compiler

Regular Expressions
for Rules

Composed
Rule FSTs

Building a lexical transducer

big | clear | clever | ear | fat | ...

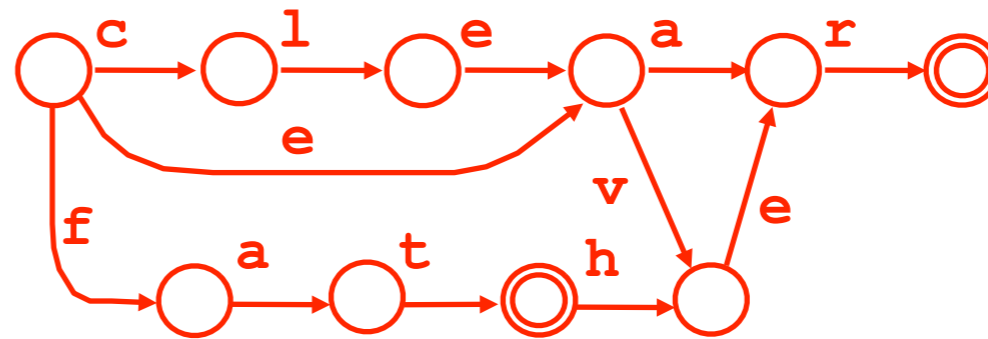

Regular Expression
Lexicon

Lexicon
FSA

Compiler

composition

Lexical Transducer
(a single FST)

Regular Expressions
for Rules

Composed
Rule FSTs

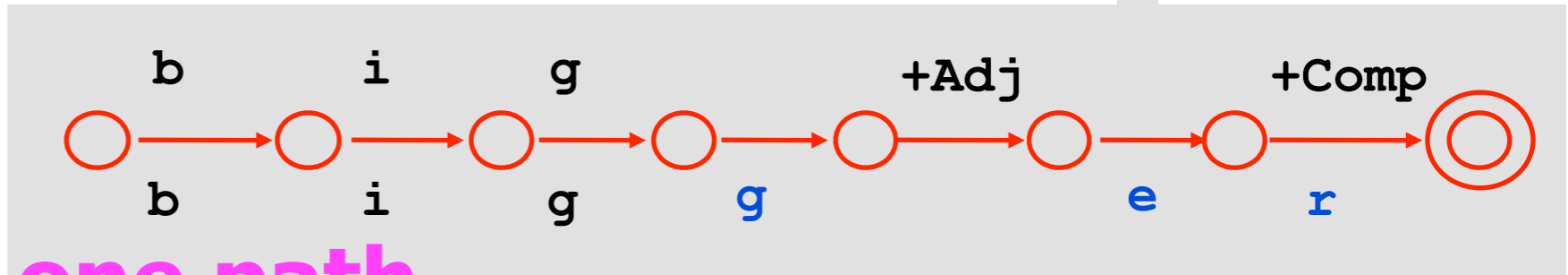

one path

Building a lexical transducer

big | clear | clever | ear | fat | ...

Regular Expression
Lexicon



Lexicon
FSA

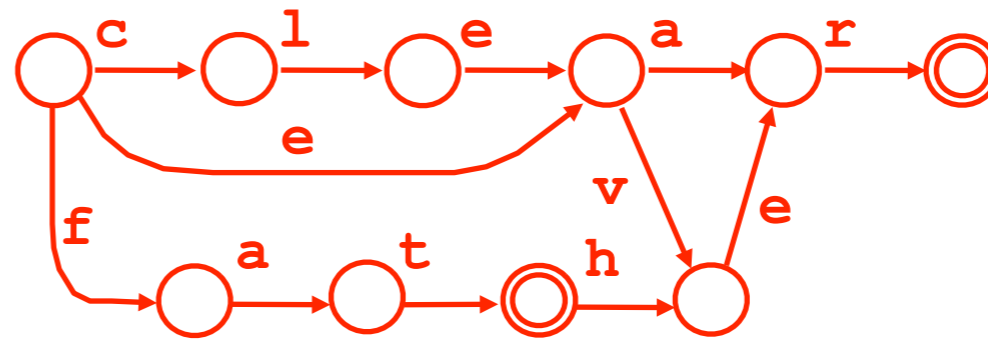

Building a lexical transducer

big | clear | clever | ear | fat | ...

Regular Expression
Lexicon

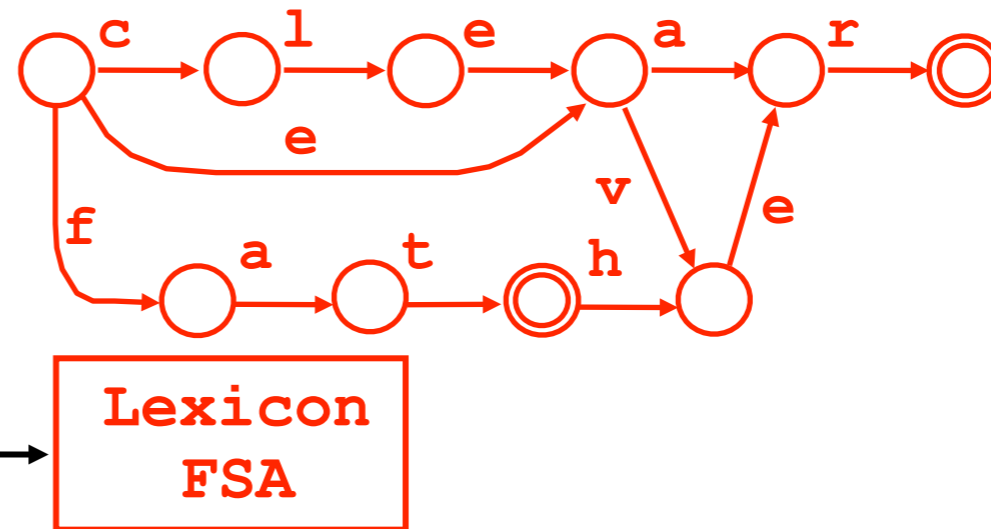

- Actually, the lexicon must contain elements like **big +Adj +Comp**

Building a lexical transducer

big | clear | clever | ear | fat | ...

Regular Expression
Lexicon

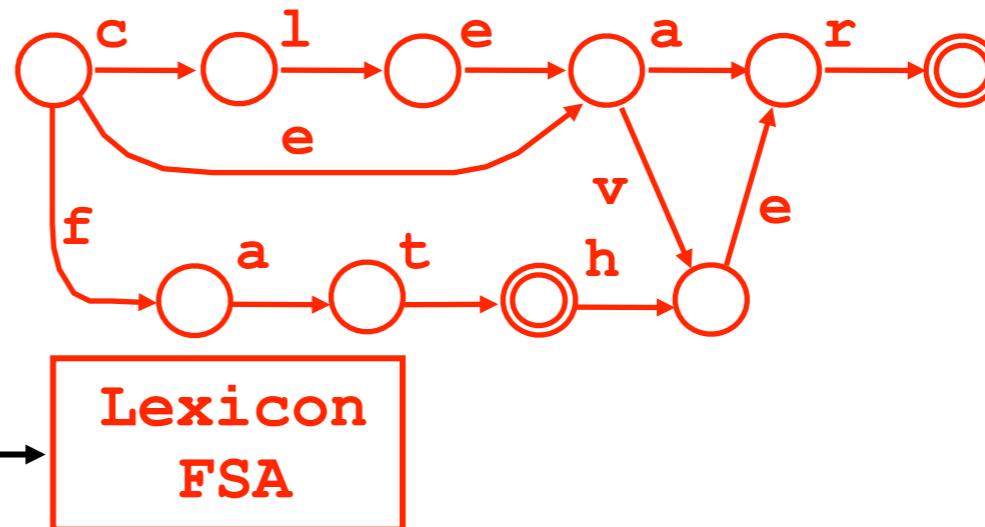

- Actually, the lexicon must contain elements like **big +Adj +Comp**

- So write it as a more complicated expression:

(big | clear | clever | fat | ...) +Adj (ϵ | +Comp | +Sup) ← *adjectives*
 | (ear | father | ...) +Noun (+Sing | +Pl) ← *nouns*
 | ... ← ...

Building a lexical transducer

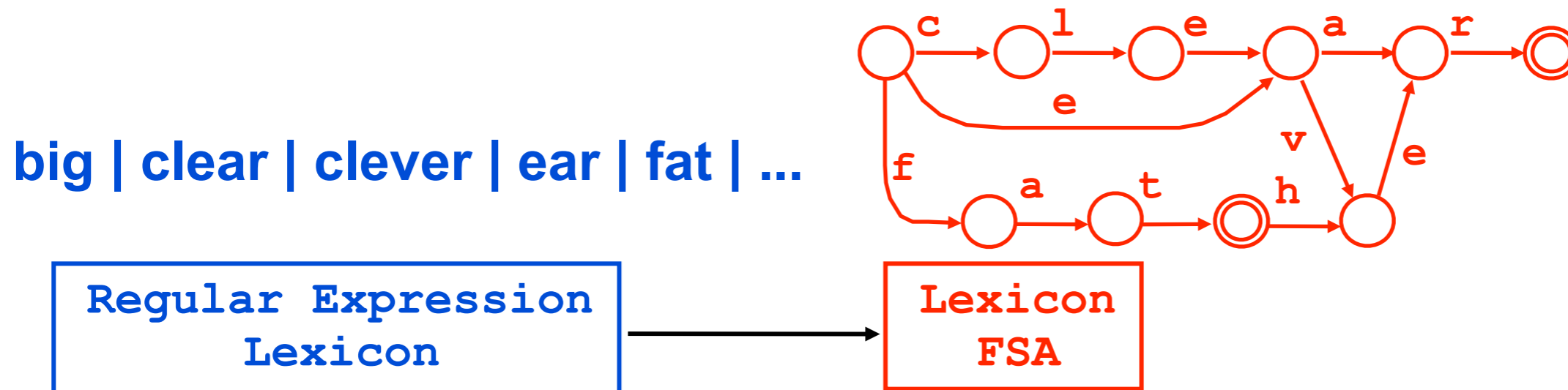

- Actually, the lexicon must contain elements like **big +Adj +Comp**
- So write it as a more complicated expression:
 (big | clear | clever | fat | ...) +Adj (ϵ | +Comp | +Sup) ← *adjectives*
 | (ear | father | ...) +Noun (+Sing | +Pl) ← *nouns*
 | ... ← *...*
- Q: Why do we need a lexicon at all?

Weighted version of transducer: Assigns a weight to each string pair

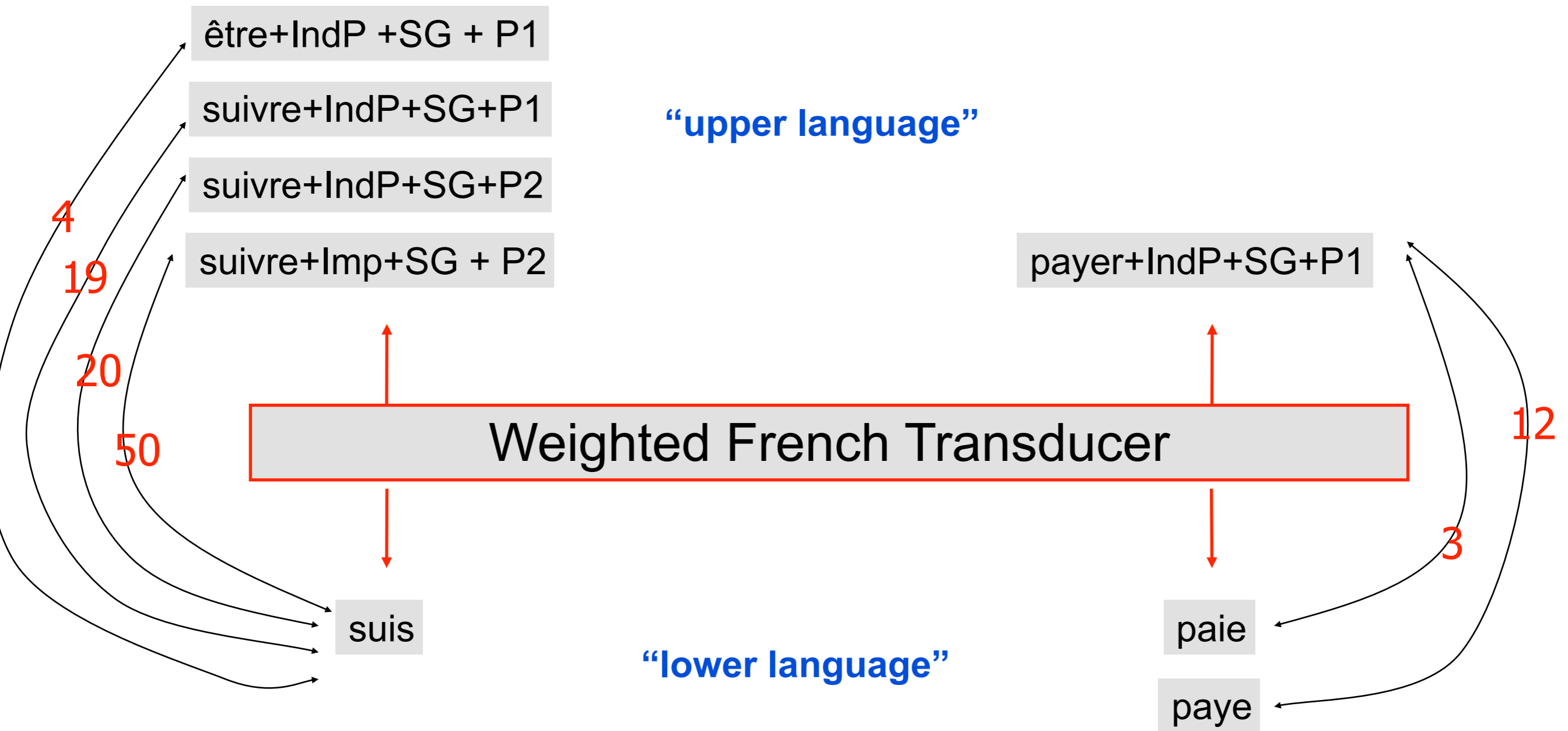

Constructing Regular Languages

Xerox Regex Notation (Paper)

	concatenation	EF
$*$ $+$	iteration	E^*, E^+
$ $	union	$E F$
$\&$	intersection	$E \& F$
\sim \backslash $-$	complementation, minus	$\sim E, \backslash x, F-E$
$.x.$	crossproduct	$E .x. F$
$.o.$	composition	$E .o. F$
$.u$	upper (input) language	$E.u$ "domain"
$.l$	lower (output) language	$E.l$ "range"

Common Regular Expression Operators (in XFST notation)

concatenation

EF

$$EF = \{ef: e \in E, f \in F\}$$

ef denotes the concatenation of 2 strings.

EF denotes the concatenation of 2 languages.

- To pick a string in EF , pick $e \in E$ and $f \in F$ and concatenate them.
- To find out whether $w \in EF$, look for at least one way to split w into two "halves," $w = ef$, such that $e \in E$ and $f \in F$.

A **language** is a set of strings.

It is a **regular language** if there exists an FSA that accepts all the strings in the language, and no other strings.

If E and F denote regular languages, then so does EF .
(We will have to prove this by finding the FSA for EF !)

Common Regular Expression Operators (in XFST notation)

concatenation EF

* + iteration E^*, E^+

$$E^* = \{e_1e_2 \dots e_n : n \geq 0, e_1 \in E, \dots e_n \in E\}$$

- To pick a string in E^* , pick any number of strings in E and concatenate them.
- To find out whether $w \in E^*$, look for at least one way to split w into 0 or more sections, $e_1e_2 \dots e_n$, all of which are in E .

$$E^+ = \{e_1e_2 \dots e_n : n > 0, e_1 \in E, \dots e_n \in E\} = EE^*$$

Common Regular Expression Operators (in XFST notation)

		concatenation	EF
$*$	$+$	iteration	E^*, E^+
$ $		union	$E F$

$$E | F = \{w: w \in E \text{ or } w \in F\} = E \cup F$$

- To pick a string in $E | F$, pick a string from either E or F .
- To find out whether $w \in E | F$, check whether $w \in E$ or $w \in F$.

Common Regular Expression Operators (in XFST notation)

	concatenation	EF
$*$ $+$	iteration	E^*, E^+
$ $	union	$E F$
$\&$	intersection	$E \& F$

$$E \& F = \{w: w \in E \text{ and } w \in F\} = E \cap F$$

- To pick a string in $E \& F$, pick a string from E that is also in F .
- To find out whether $w \in E \& F$, check whether $w \in E$ and $w \in F$.

Common Regular Expression Operators (in XFST notation)

	concatenation	EF
$*$ $+$	iteration	E^*, E^+
$ $	union	$E F$
$\&$	intersection	$E \& F$
\sim \backslash $-$	complementation, minus	$\sim E, \backslash x, F-E$

$$\sim E = \{e: e \notin E\} = \Sigma^* - E$$

$$E - F = \{e: e \in E \text{ and } e \notin F\} = E \& \sim F$$

$$\backslash E = \Sigma - E \quad (\text{any single character not in } E)$$

Σ is set of all letters; so Σ^* is set of all strings; $?^*$ in XFST

Regular Expressions

A **language** is a set of strings.

It is a **regular language** if there exists an FSA that accepts all the strings in the language, and no other strings.

If E and F denote regular languages, than so do EF , etc.

Regular expression: $EF^*|(F \& G)^+$

Syntax:

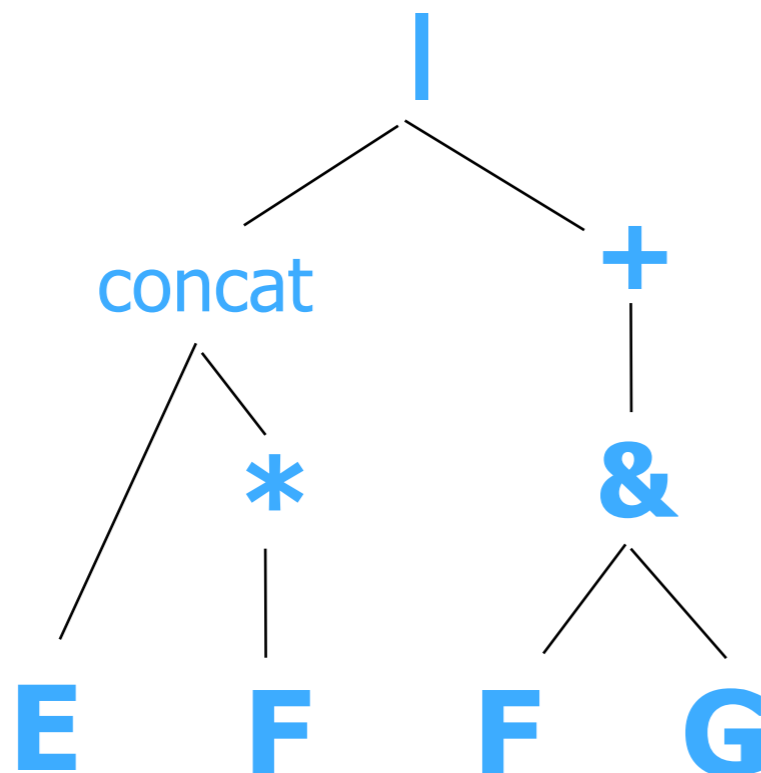

Semantics:

Denotes a regular language. As usual, can build semantics compositionally bottom-up. E, F, G must be regular languages. As a base case, e denotes $\{e\}$ (a language containing a single string), so $ef^*|(f\&g)^+$ is regular.

Regular Expressions for Regular Relations

A **language** is a set of strings.

It is a **regular language** if there exists an FSA that accepts all the strings in the language, and no other strings.

If E and F denote regular languages, then so do EF, etc.

A **relation** is a set of pairs – here, pairs of strings.

It is a **regular relation** if there exists an FST that accepts all the pairs in the language, and no other pairs.

If E and F denote regular relations, then so do EF, etc.

$$EF = \{(ef, e'f') : (e, e') \in E, (f, f') \in F\}$$

Can you guess the definitions for E^* , E^+ , $E \mid F$, $E \& F$ when E and F are regular relations?

Surprise: $E \& F$ isn't necessarily regular in the case of relations; so not supported.

Common Regular Expression Operators (in XFST notation)

	concatenation	EF
$*$ $+$	iteration	E^*, E^+
$ $	union	$E F$
$\&$	intersection	$E \& F$
\sim \backslash $-$	complementation, minus	$\sim E, \backslash x, F-E$
$.x.$	crossproduct	$E .x. F$

$$E .x. F = \{(e, f): e \in E, f \in F\}$$

- Combines two regular languages into a regular relation.

Common Regular Expression Operators (in XFST notation)

	concatenation	EF
$*$ $+$	iteration	E^*, E^+
$ $	union	$E F$
$\&$	intersection	$E \& F$
\sim \backslash $-$	complementation, minus	$\sim E, \backslash x, F-E$
$.x.$	crossproduct	$E .x. F$
$.o.$	composition	$E .o. F$

$$E .o. F = \{(e,f): \exists m. (e,m) \in E, (m,f) \in F\}$$

- Composes two regular relations into a regular relation.
- As we've seen, this generalizes ordinary function composition.

Common Regular Expression Operators (in XFST notation)

	concatenation	EF
$*$ $+$	iteration	E^*, E^+
$ $	union	$E F$
$\&$	intersection	$E \& F$
\sim \backslash $-$	complementation, minus	$\sim E, \backslash x, F-E$
$\cdot x \cdot$	crossproduct	$E \cdot x \cdot F$
$\cdot o \cdot$	composition	$E \cdot o \cdot F$
$\cdot u$	upper (input) language	$E \cdot u$ "domain"

$$E \cdot u = \{e: \exists m. (e, m) \in E\}$$

Common Regular Expression Operators (in XFST notation)

	concatenation	EF
$*$ $+$	iteration	E^*, E^+
$ $	union	$E F$
$\&$	intersection	$E \& F$
\sim \backslash $-$	complementation, minus	$\sim E, \backslash x, F-E$
$.x.$	crossproduct	$E .x. F$
$.o.$	composition	$E .o. F$
$.u$	upper (input) language	$E.u$ "domain"
$.l$	lower (output) language	$E.l$ "range"

Finite-State Programming

Finite-state “programming”

Function	Function on (set of) strings
Source code Object code	Regular expression Finite state machine
Compiler Optimization of object code	Regex compiler Determinization, minimization, pruning

Finite-state “programming”

Function composition

(Weighted) composition

Higher-order function

Operator

Function inversion
(available in Prolog)

Function inversion

Structured
programming

Ops + small regexps

Finite-state “programming”

Parallelism

Apply to set of strings

Nondeterminism

Nondeterminism

Stochasticity

Prob.-weighted arcs

Some Xerox Extensions

\$ containment

=> restriction

-> @-> replacement

Make it easier to describe complex languages and relations without extending the formal power of finite-state systems.

Containment

Containment

`$[ab*c]`

“Must contain a substring
that matches `ab*c`.”

Accepts `xxxacyy`

Rejects `bcba`

Containment

$\$[ab^*c]$

“Must contain a substring that matches ab^*c .”

Accepts **xxxacyy**

Rejects **bcba**

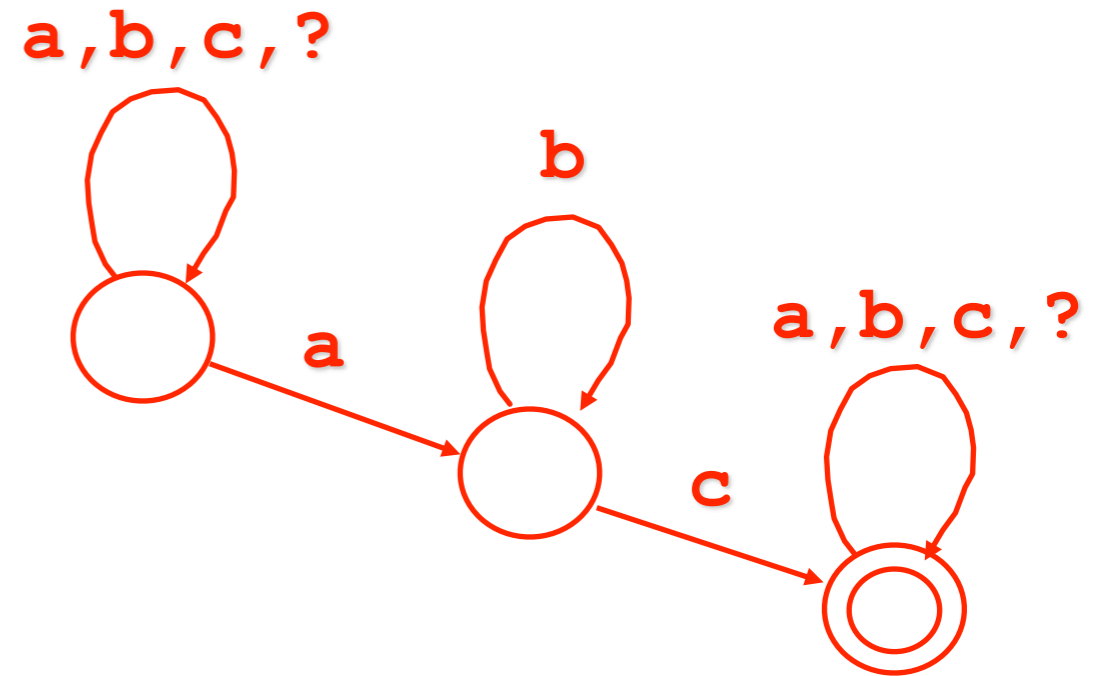

Containment

$\$[ab^*c]$

“Must contain a substring that matches ab^*c .”

Accepts **xxxacyy**

Rejects **bcba**

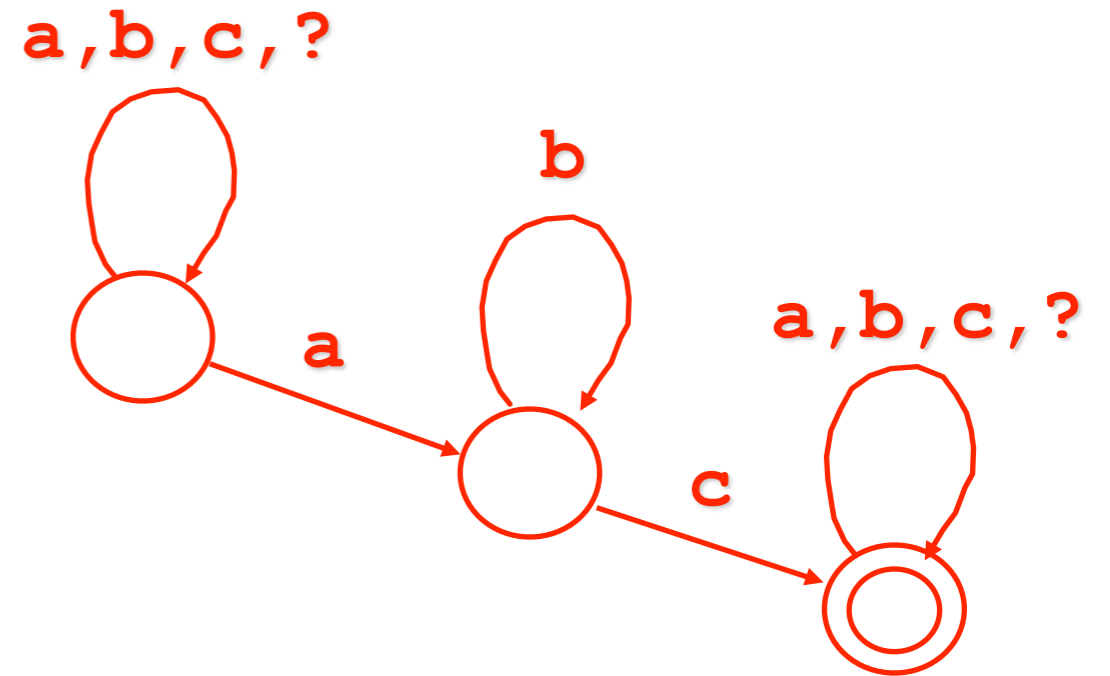

$?*[ab^*c]?*$

Equivalent expression

Containment

`$[ab*c]`

“Must contain a substring that matches `ab*c`.”

Accepts `xxxacyy`
Rejects `bcba`

`?*[ab*c]?*`

Equivalent expression

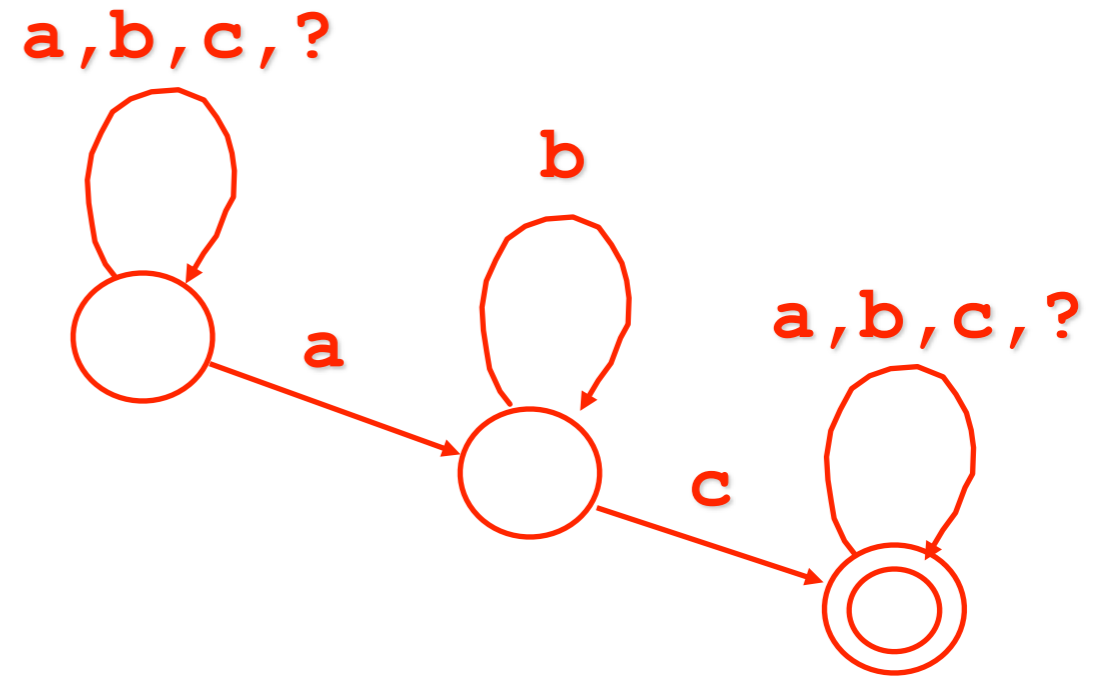

Warning: `?` in regexps means “any character at all.”
But `?` in machines means “any character not explicitly mentioned anywhere in the machine.”

Restriction

Restriction

a => **b** **c**

“Any **a** must be preceded by **b**
and followed by **c**.”

Accepts **bacbbacde**

Rejects **baca**

Restriction

$a \Rightarrow b _ c$

“Any **a** must be preceded by **b**
and followed by **c**.”

Accepts **bacbbacde**

Rejects **baca**

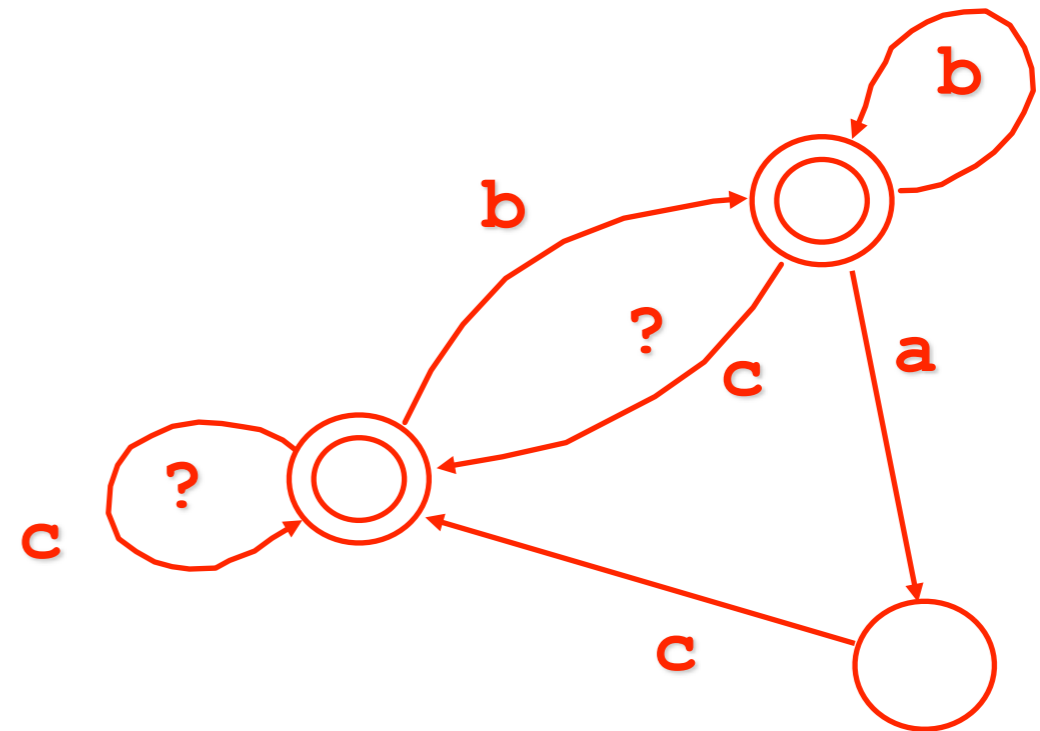

Restriction

$a \Rightarrow b _ c$

“Any **a** must be preceded by **b**
and followed by **c**.”

Accepts **bacbbacde**

Rejects **baca**

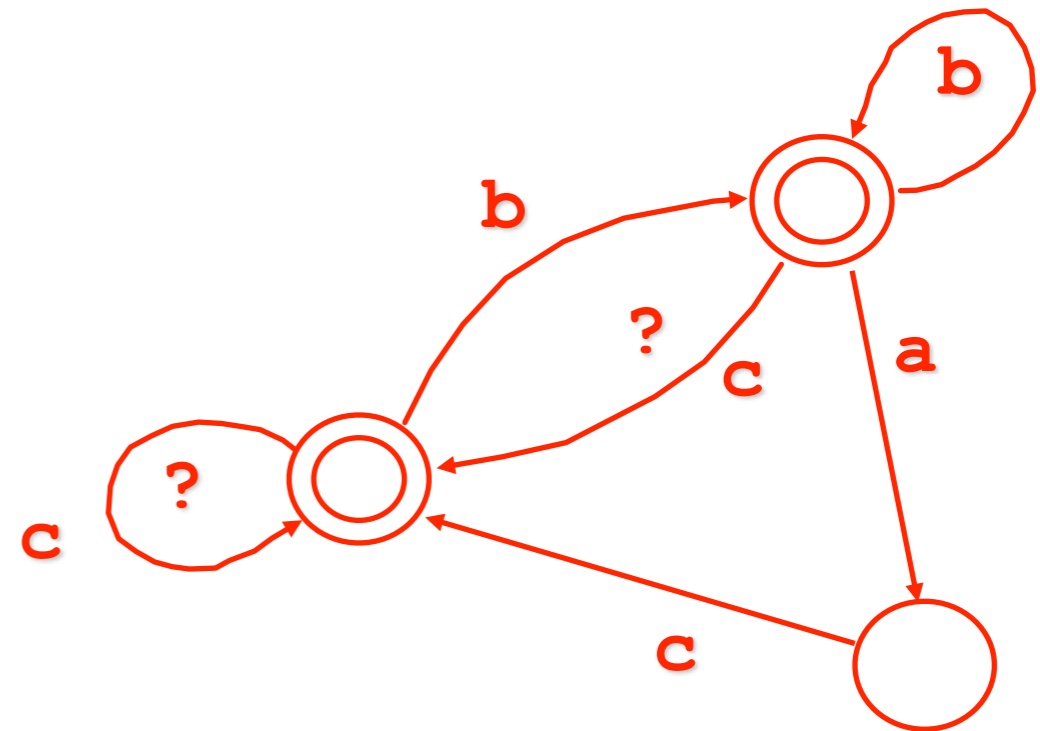

$\sim [\sim [?^* b] a ?^*] \ \& \ \sim [?^* a \sim [c ?^*]]$

Equivalent expression

Restriction

$a \Rightarrow b _ c$

“Any **a** must be preceded by **b**
and followed by **c**.”

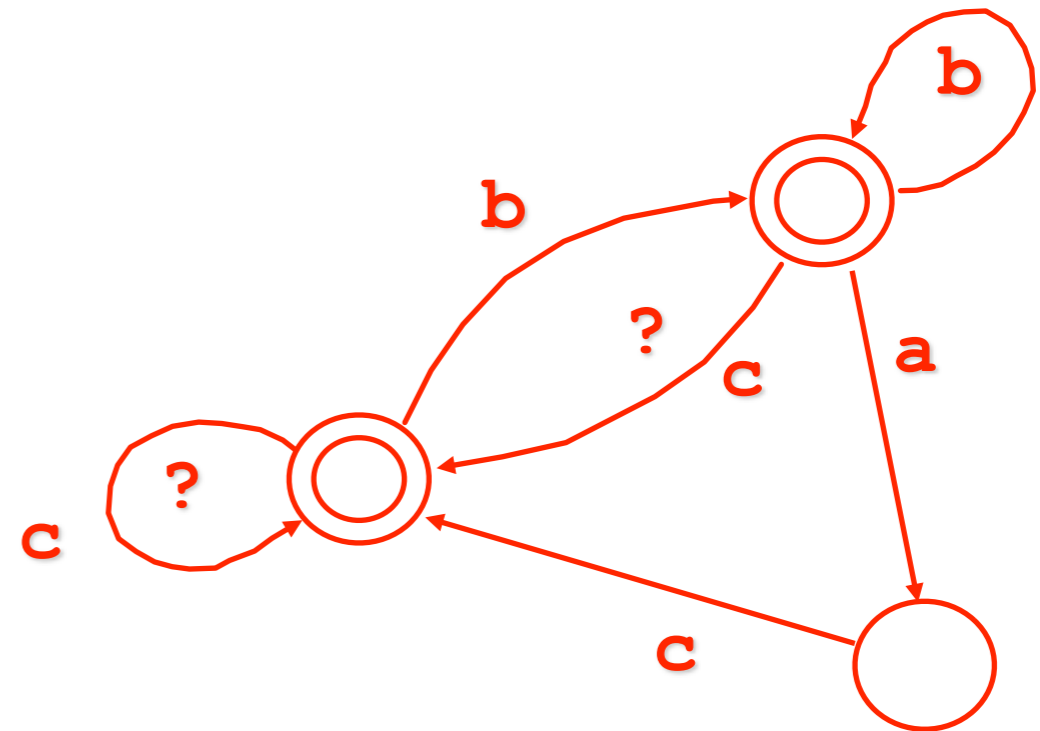

Accepts **bacbbacde**

Rejects **baca**

contains a not preceded by b

$\sim [\sim [?^* b] a ?^*] \ \& \ \sim [?^* a \sim [c ?^*]]$

Equivalent expression

Restriction

$a \Rightarrow b _ c$

“Any **a** must be preceded by **b**
and followed by **c**.”

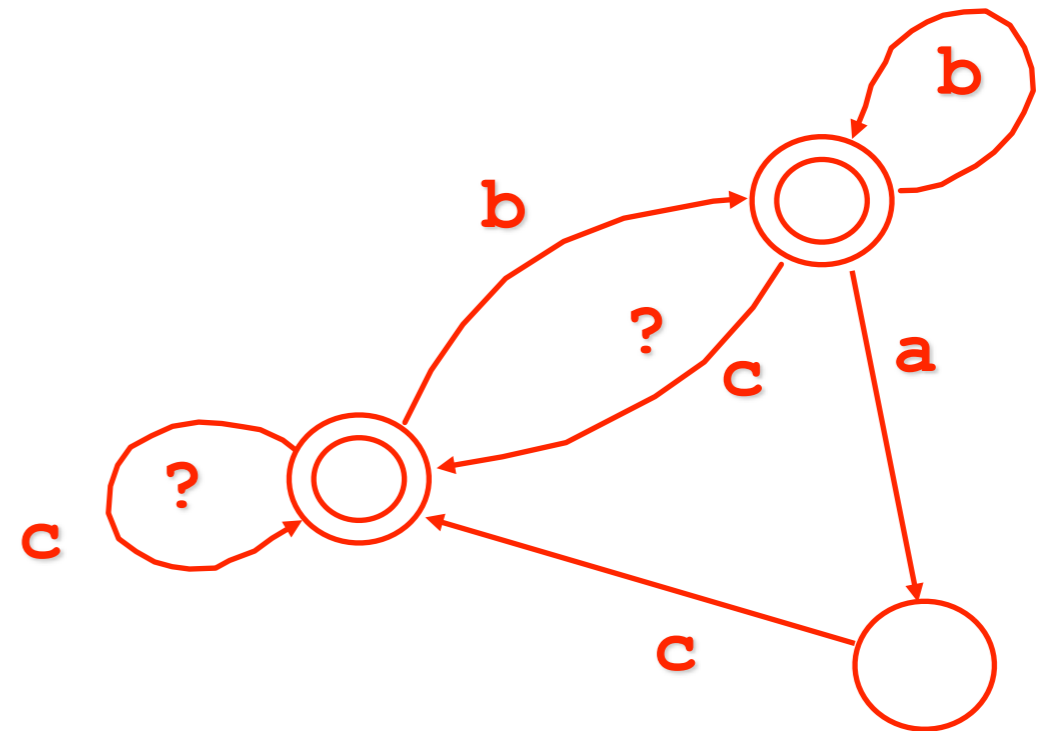

Accepts **bacbbacde**

Rejects **baca**

contains a not preceded by b

contains a not followed by c

$\sim [\sim [?^* b] a ?^*] \ \& \ \sim [?^* a \sim [c ?^*]]$

Equivalent expression

Replacement

Replacement

a b -> b a

“Replace ‘ab’ by ‘ba’.”

Transduces abcdba
to bacdba

Replacement

a b -> b a

“Replace ‘ab’ by ‘ba’.”

Transduces abcdba
to bacdba

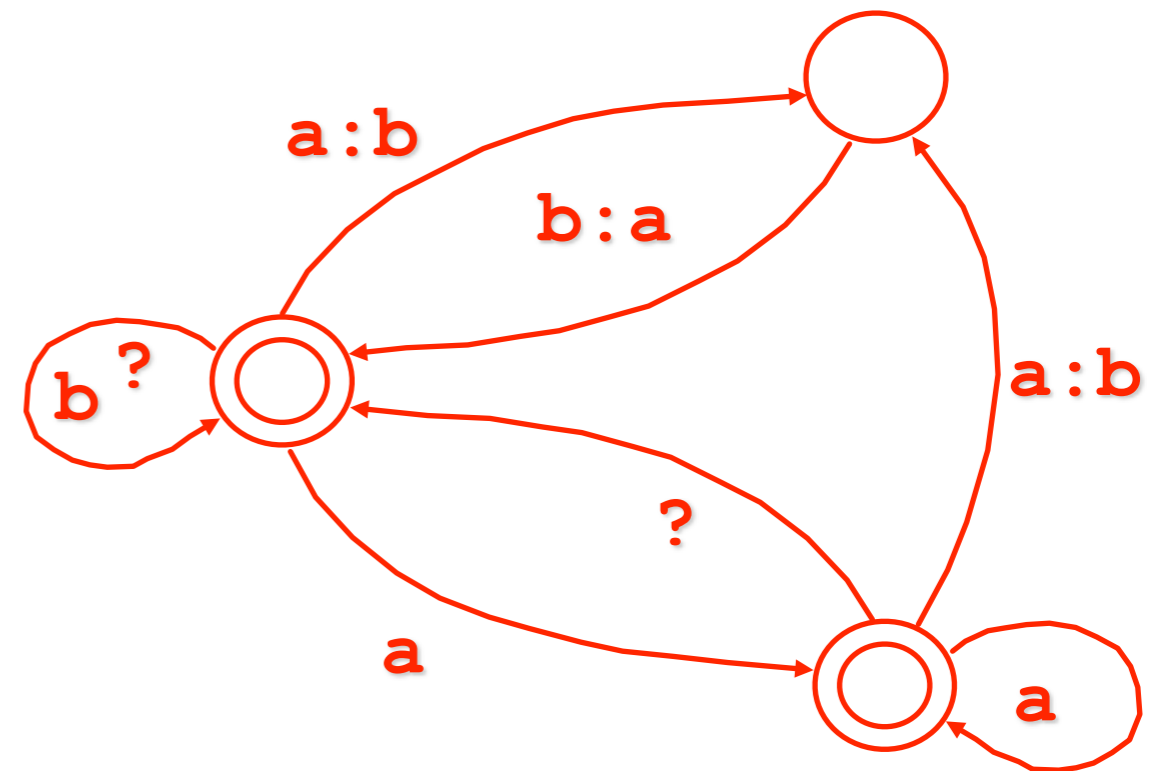

Replacement

a b -> b a

“Replace ‘ab’ by ‘ba’.”

Transduces abcdba
to bacdba

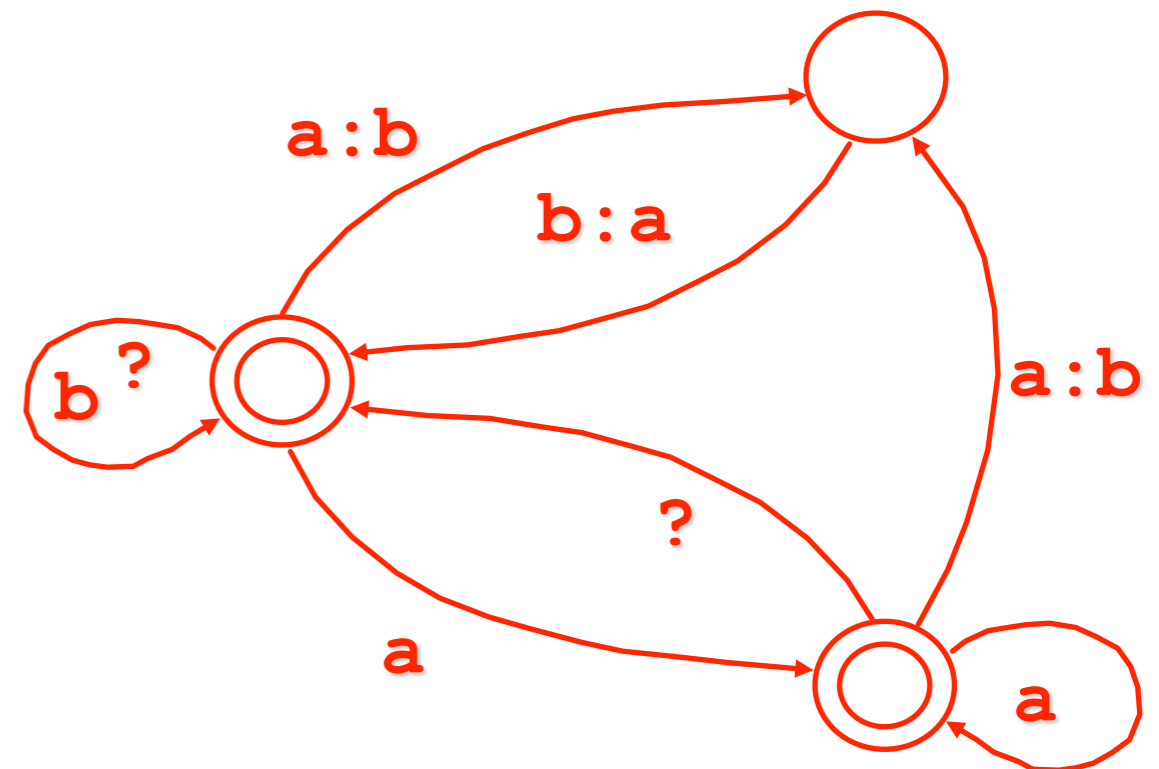

$[\sim \$ [a b] [[a b] .x. [b a]] * \sim \$ [a b]$

Equivalent expression

Replacement is Nondeterministic

Replacement is Nondeterministic

a b -> b a | x

“Replace ‘ab’ by ‘ba’ or ‘x’, nondeterministically.”

Transduces abcdbabaa
to {bacdbbaa, bacdbxa, xcdbbaa, xcdbxa}

Replacement is Nondeterministic

[a b -> b a | x] .o. [x => _ c]

“Replace ‘ab’ by ‘ba’ or ‘x’, nondeterministically.”

Transduces abcdbaba
to {bacdbbaa, bacdbxa, xcdbbaa, xcdbxa}

Replacement is Nondeterministic

[a b -> b a | x] .o. [x => _ c]

“Replace ‘ab’ by ‘ba’ or ‘x’, nondeterministically.”

Transduces abcdbaba
to {bacdbbaa, ~~bacdbxa~~, xcdbbaa, ~~xcdbxa~~}

More Replace Operators

- Optional replacement: $a b (->) b a$
- Directed replacement
 - guarantees a unique result by constraining the factorization of the input string by
 - Direction of the match (rightward or leftward)
 - Length (longest or shortest)

@-> Left-to-right, Longest-match Replacement

a b | b | b a | a b a @-> x

applied to "aba"

a b a	a b a	a b a	_____
<u>a b a</u>	_____	_____	_____
a x a	a x	x a	

^x@-> **left-to-right, longest match (cf. perl s///)**

@> **left-to-right, shortest match**

->@ **right-to-left, longest match**

>@ **right-to-left, shortest match**

Using “...” for marking

a|e|i|o|u -> [...]

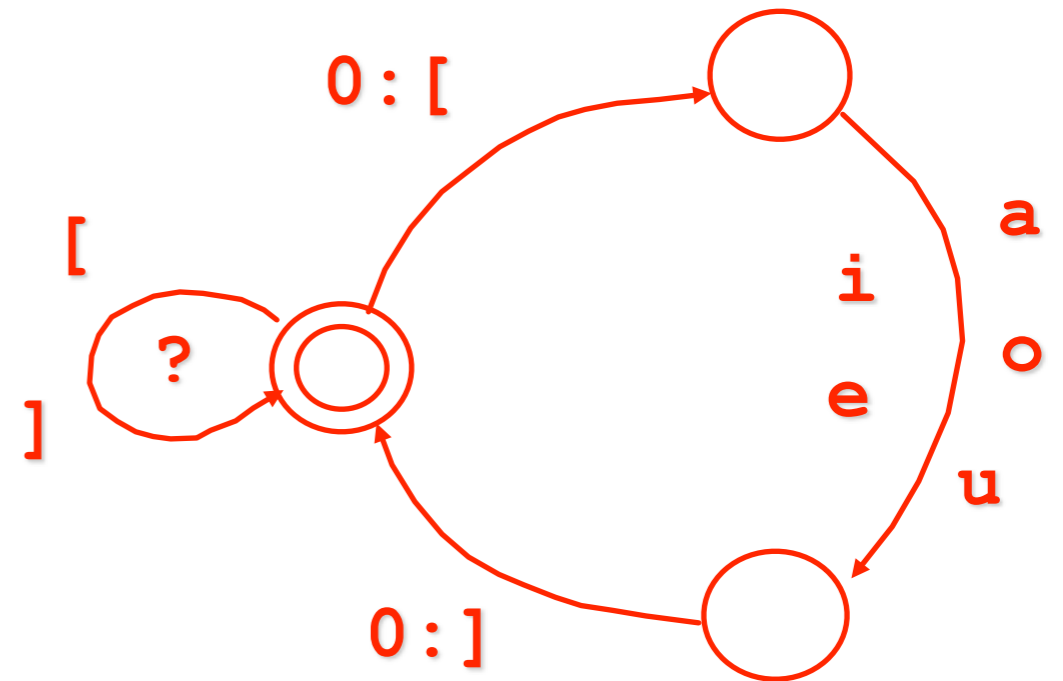

Using “...” for marking

a|e|i|o|u -> [...]

p o t a t o
p[o]t[a]t[o]

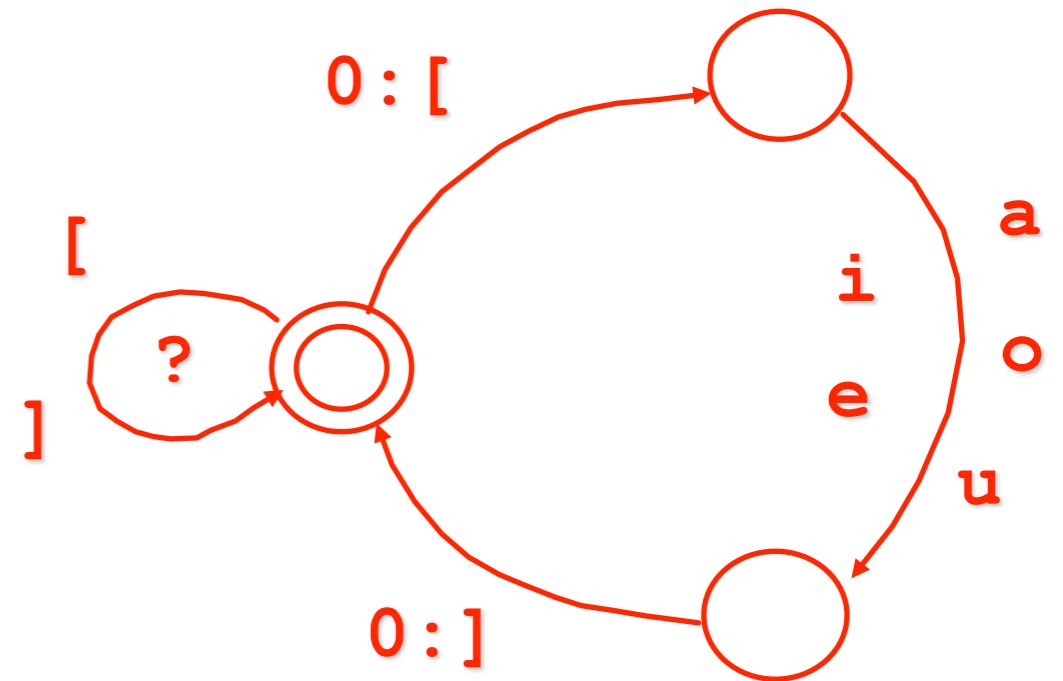

Using “...” for marking

`a|e|i|o|u -> [...]`

`p o t a t o`
`p[o]t[a]t[o]`

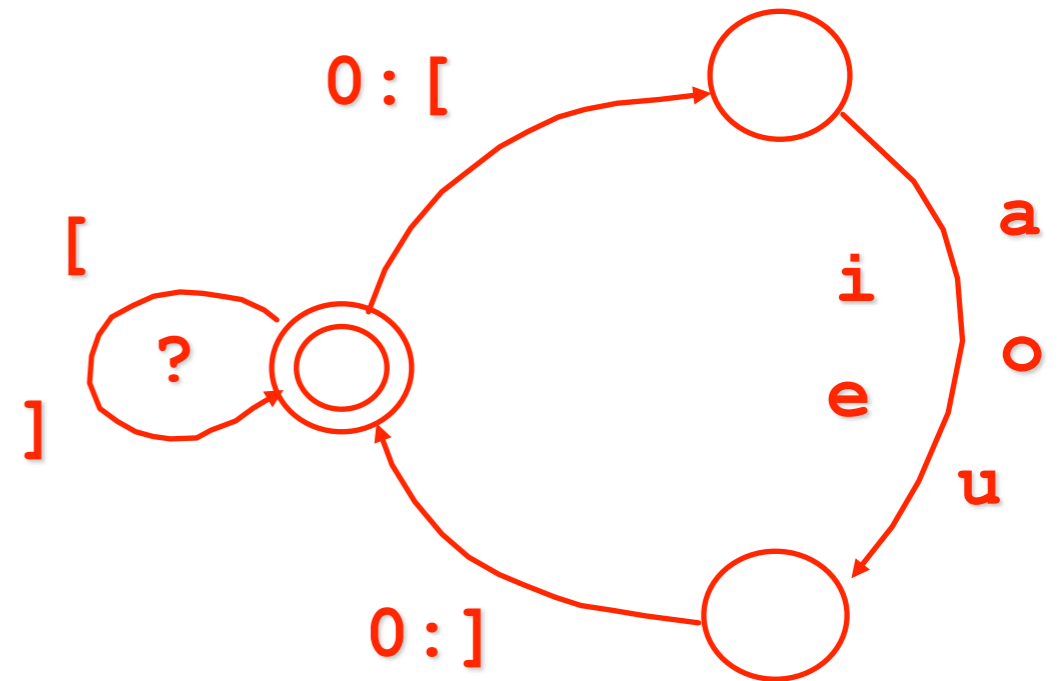

Note: actually have to write as `-> %[... %]`
or `-> "[...]"`
since `[]` are parens in the regexp language

Using “...” for marking

a|e|i|o|u -> [...]

p o t a t o
p[o]t[a]t[o]

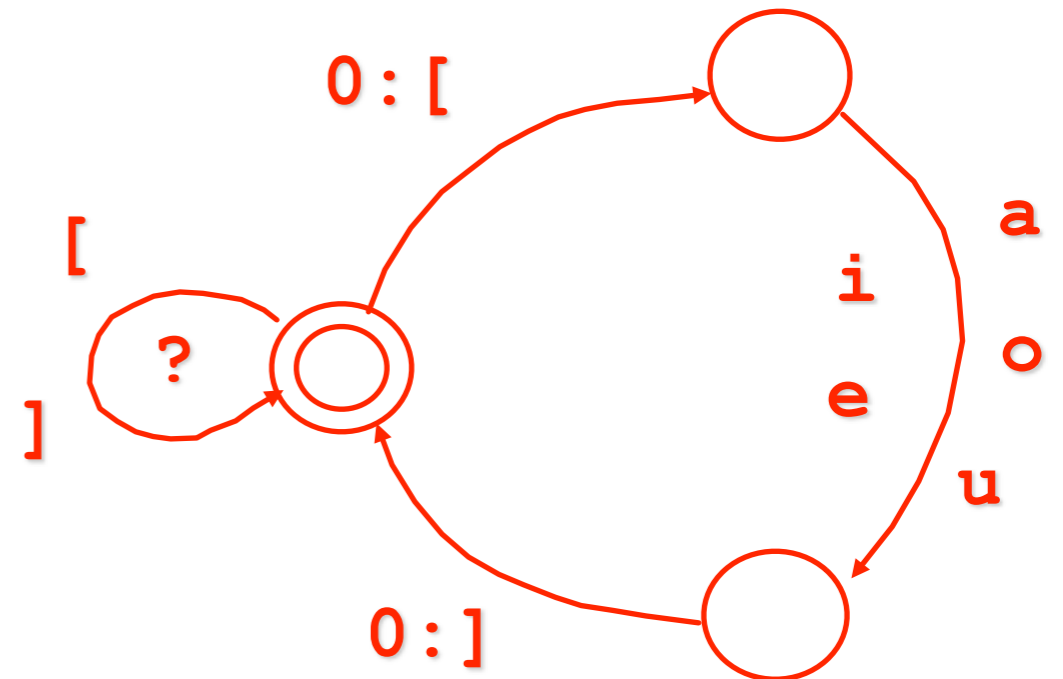

Which way does the FST transduce potatoe?

p o t a t o e
p[o]t[a]t[o][e]

vs.

p o t a t o e
p[o]t[a]t[o e]

Using “...” for marking

a|e|i|o|u -> [...]

p o t a t o
p[o]t[a]t[o]

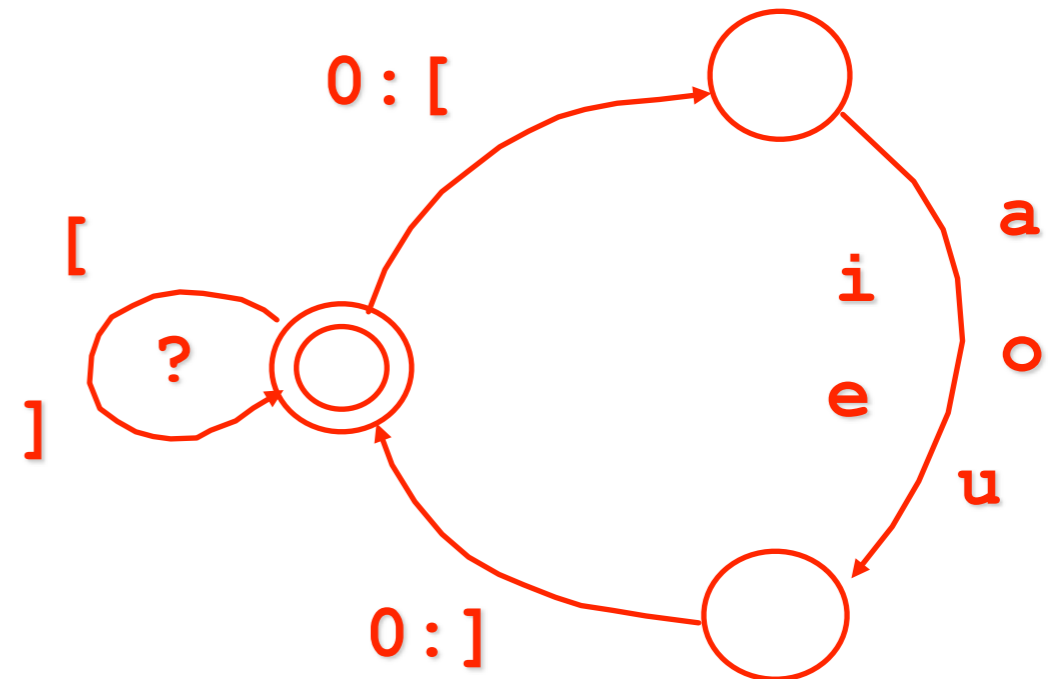

Which way does the FST transduce potatoe?

p o t a t o e
p[o]t[a]t[o][e]

vs.

p o t a t o e
p[o]t[a]t[o e]

How would you change it to get the other answer?

Example: Finnish Syllabification

Example: Finnish Syllabification

define C [b | c | d | f ...

define V [a | e | i | o | u | y | ä | ...

Example: Finnish Syllabification

```
define C [ b | c | d | f ...
define V [ a | e | i | o | u | y | ä | ...
```

```
[C* V+ C*] @-> ... "-" | | _ [C V]
```

“Insert a hyphen after the longest instance of the
C* V+ C* pattern in front of a **C V** pattern.”

Example: Finnish Syllabification

```
define C [ b | c | d | f ...
```

```
define V [ a | e | i | o | u | y | ä | ...
```

```
[C* V+ C*] @-> ... "-" | | _ [C V]
```

“Insert a hyphen after the longest instance of the
C* V+ C* pattern in front of a **C V** pattern.”

```
s t r u k      t u      r a      l i s      m i
s t r u k - t u - r a - l i s - m i
```

Example: Finnish Syllabification

```
define C [ b | c | d | f ...
```

```
define V [ a | e | i | o | u | y | ä | ...
```

```
[C* V+ C*] @-> ... "-" | | _ [C V]
```

“Insert a hyphen after the longest instance of the
~~C* V+ C*~~ pattern in front of a ~~C V~~ pattern.” why?

```
s t r u k      t u      r a      l i s      m i
s t r u k - t u - r a - l i s - m i
```

Conditional Replacement

Conditional Replacement

A \rightarrow **B**

Replacement

L $_$ **R**

Context

The relation that replaces **A** by **B** between **L** and **R** leaving everything else unchanged.

Conditional Replacement

A \rightarrow **B**

Replacement

L $_$ **R**

Context

The relation that replaces **A** by **B** between **L** and **R** leaving everything else unchanged.

Sources of complexity:

- Replacements and contexts may overlap
- Alternative ways of interpreting “between left and right.”

Hand-Coded Example: slide courtesy of L. Karttunen Parsing Dates

Today is [Tuesday, July 25, 2000].

Hand-Coded Example: slide courtesy of L. Karttunen Parsing Dates

Today is [Tuesday, July 25, 2000].

Best result

Today is Tuesday, [July 25, 2000].

Today is [Tuesday, July 25], 2000.

Today is Tuesday, [July 25], 2000.

Today is [Tuesday], July 25, 2000.

Bad results

Hand-Coded Example: slide courtesy of L. Karttunen Parsing Dates

Today is [Tuesday, July 25, 2000].

Best result

Today is Tuesday, [July 25, 2000].

Today is [Tuesday, July 25], 2000.

Today is Tuesday, [July 25], 2000.

Today is [Tuesday], July 25, 2000.

Bad results

**Need left-to-right, longest-match
constraints.**

Source code: Language of Dates

Source code: Language of Dates

```
Day = Monday | Tuesday | ... | Sunday
Month = January | February | ... | December
Date = 1 | 2 | 3 | ... | 31
Year = %0To9 (%0To9 (%0To9 (%0To9))) - %0?*
      from 1 to 9999
```

Source code: Language of Dates

```
Day = Monday | Tuesday | ... | Sunday
Month = January | February | ... | December
Date = 1 | 2 | 3 | ... | 31
Year = %0To9 (%0To9 (%0To9 (%0To9))) - %0?*
      from 1 to 9999
```

```
AllDates = Day | (Day ", ") Month " " Date (" ,
              " Year)
```

Object code:

slide courtesy of L. Karttunen

All Dates from 1/1/1 to 12/31/9999

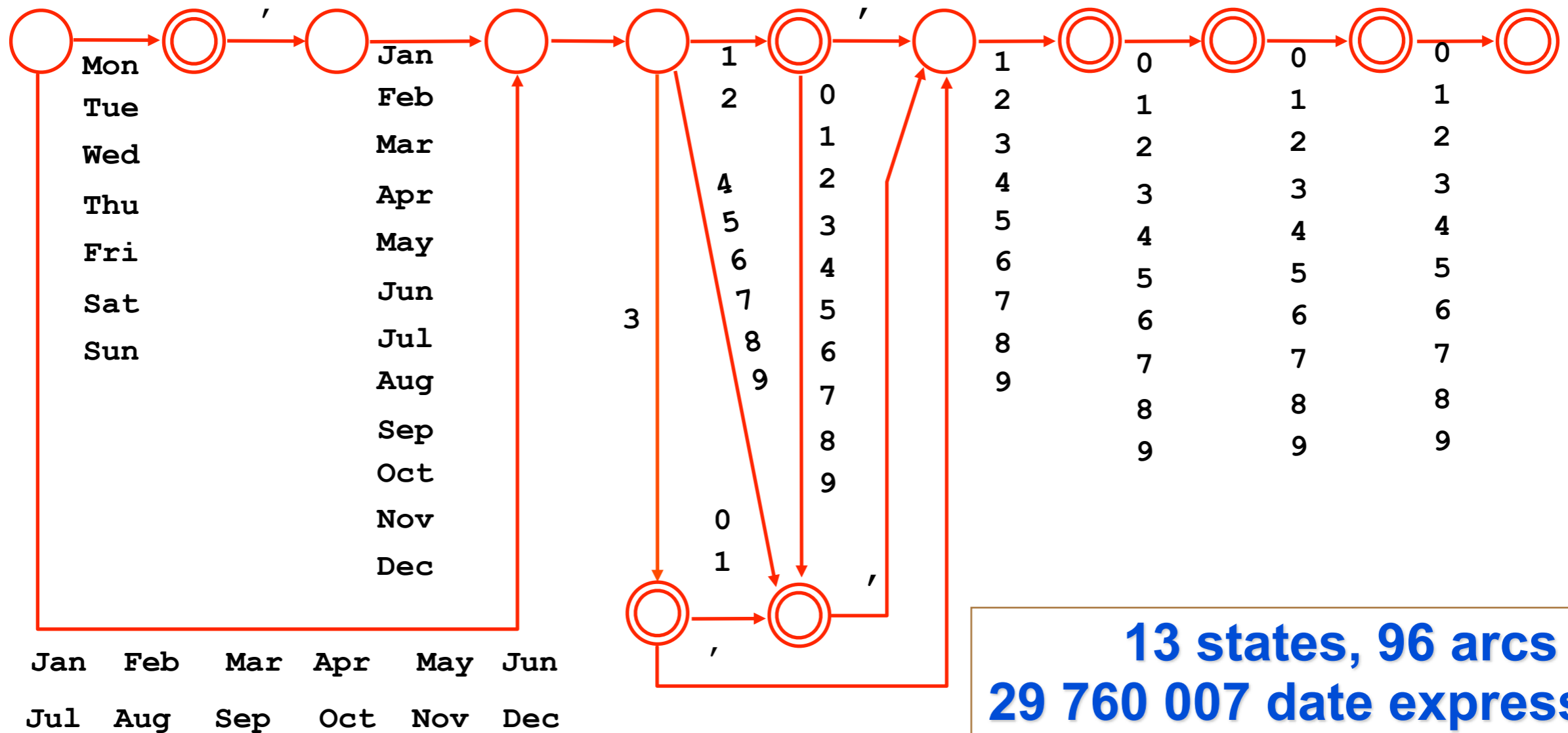

Object code:

slide courtesy of L. Karttunen

All Dates from 1/1/1 to 12/31/9999

actually represents 7 arcs, each labeled by a string

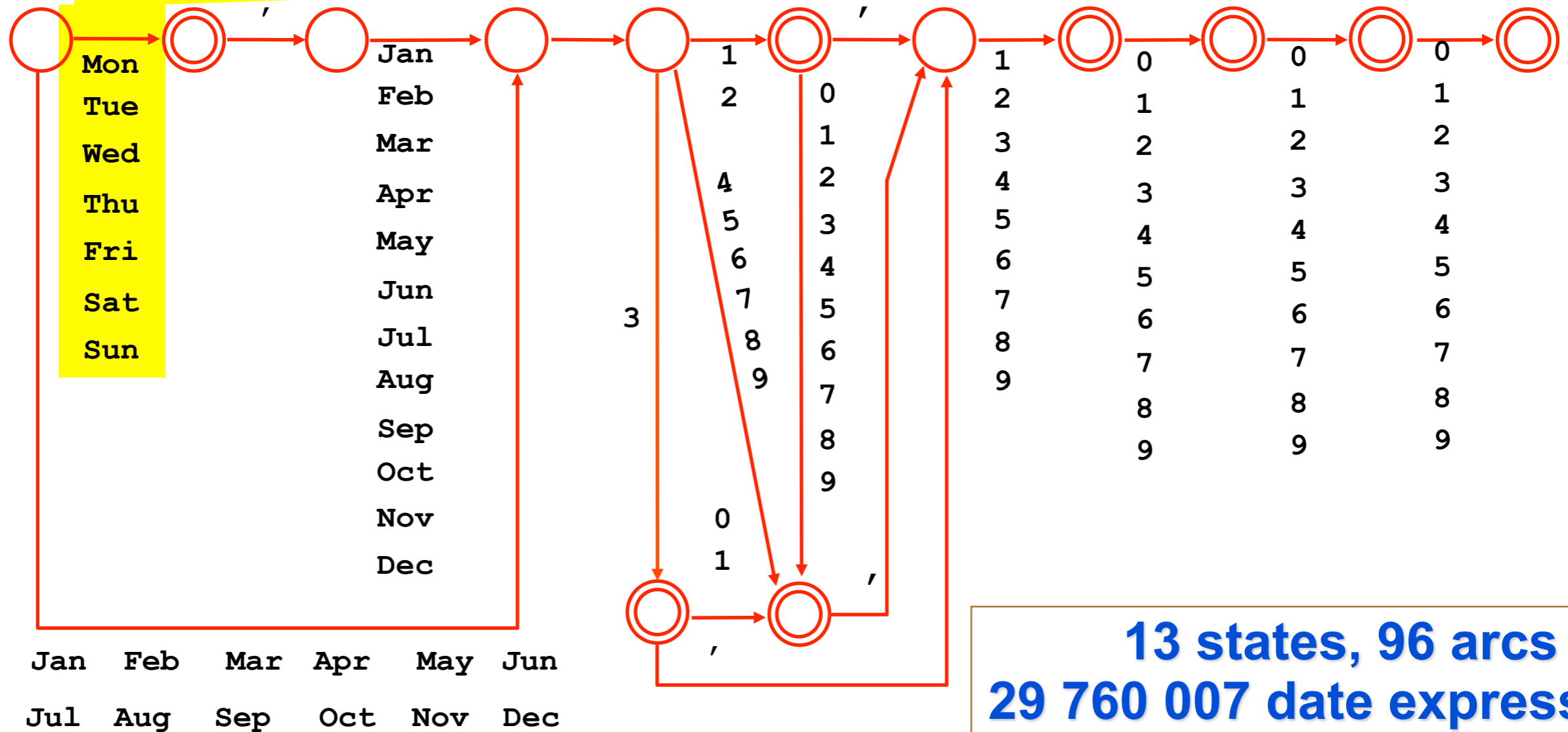

Parser for Dates

Parser for Dates

AllDates @-> "[DT " ... "]"

Parser for Dates

AllDates @-> "[DT " ... "]"

Compiles into an
unambiguous transducer
(23 states, 332 arcs).

Parser for Dates

AllDates @-> "[DT " ... "]"

Compiles into an
unambiguous transducer
(23 states, 332 arcs).

Today is [DT Tuesday, July 25, 2000] because yesterday was [DT Monday] and it was [DT July 24] so tomorrow must be [DT Wednesday, July 26] and not [DT July 27] as it says on the program.

Parser for Dates

AllDates @-> "[DT " ... "]"

Compiles into an
unambiguous transducer
(23 states, 332 arcs).

 Xerox left-to-right replacement operator

Today is [DT Tuesday, July 25, 2000] because yesterday was [DT Monday] and it was [DT July 24] so tomorrow must be [DT Wednesday, July 26] and not [DT July 27] as it says on the program.

Problem of Reference

Valid dates

Tuesday, July 25, 2000

Tuesday, February 29, 2000

Monday, September 16, 1996

Invalid dates

Wednesday, April 31, 1996

Thursday, February 29, 1900

Tuesday, July 26, 2000

Refinement by Intersection

Refinement by Intersection

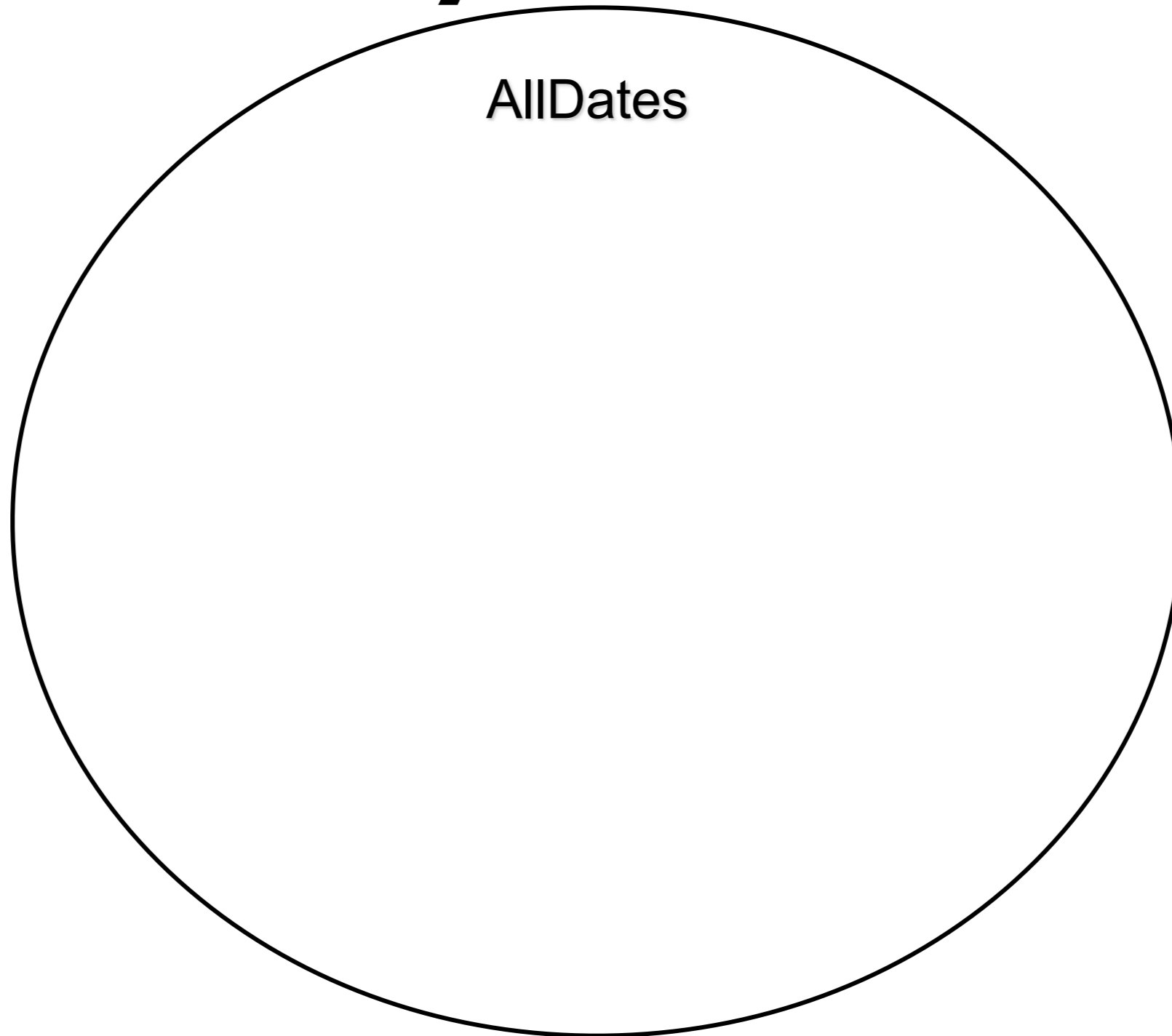

Refinement by Intersection

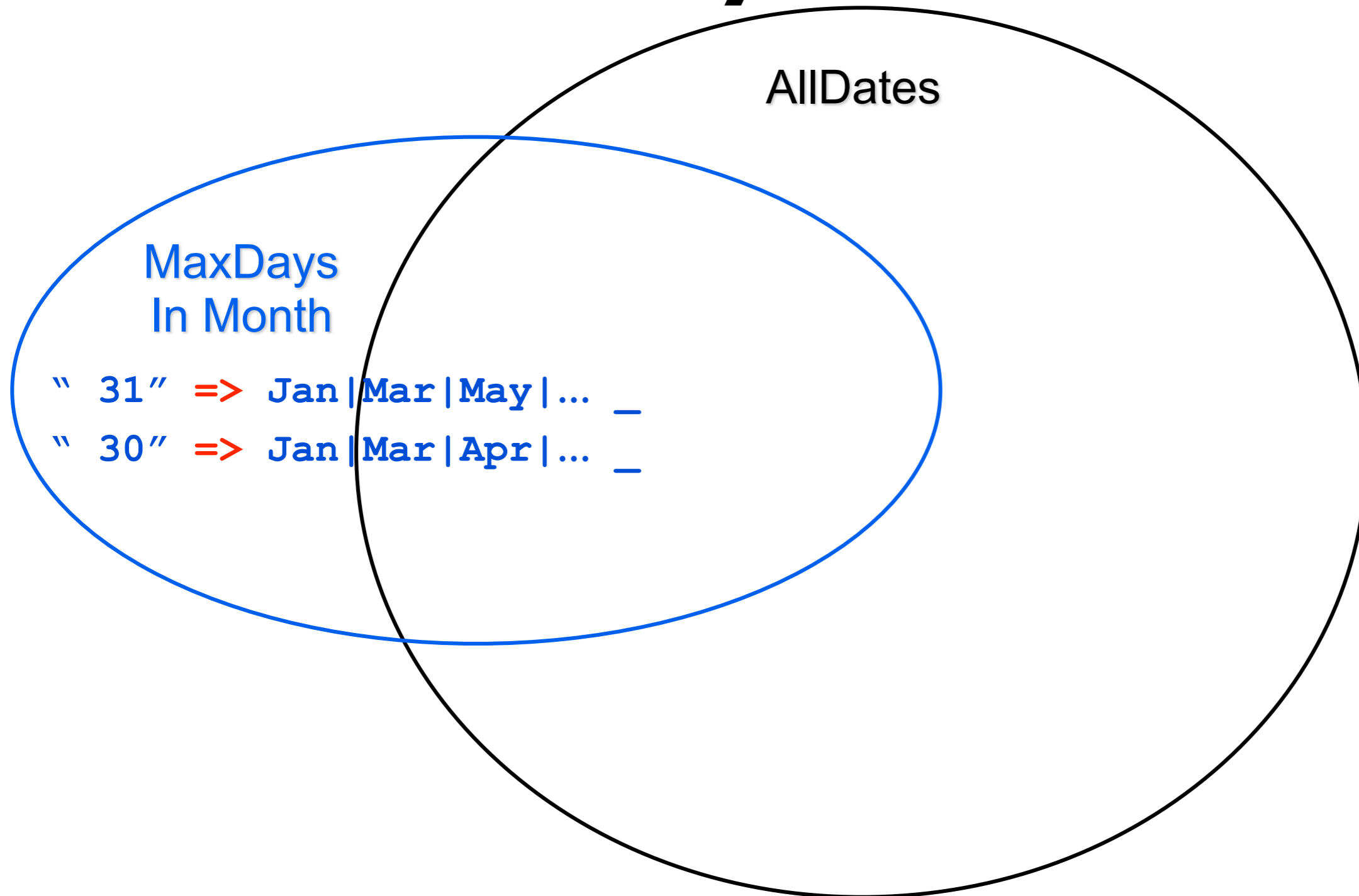

AllDates

MaxDays
In Month

" 31" => Jan | Mar | May | ... _

" 30" => Jan | Mar | Apr | ... _

Refinement by Intersection

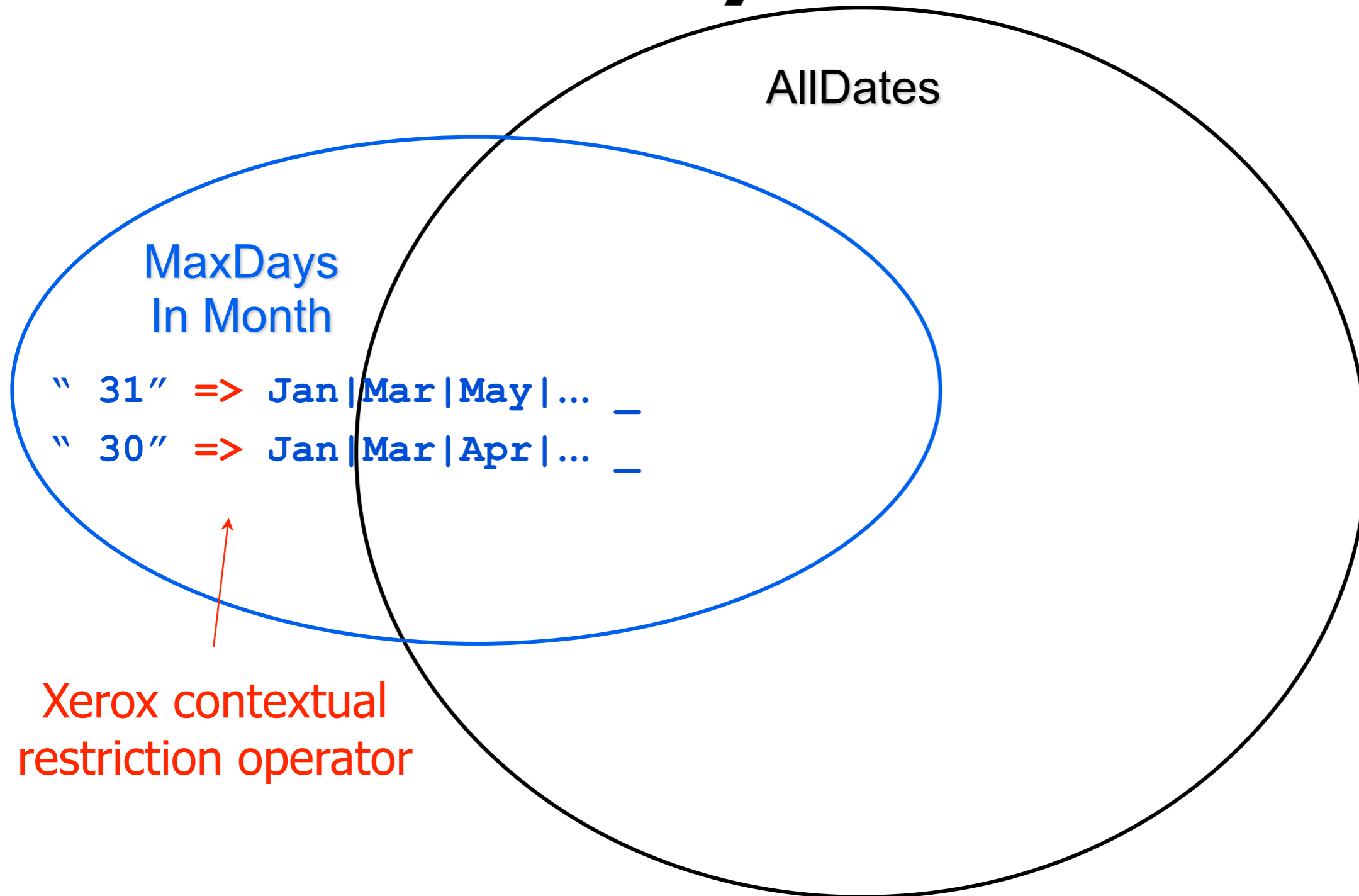

MaxDays
In Month

" 31" => Jan | Mar | May | ... _
" 30" => Jan | Mar | Apr | ... _

Xerox contextual
restriction operator

Refinement by Intersection

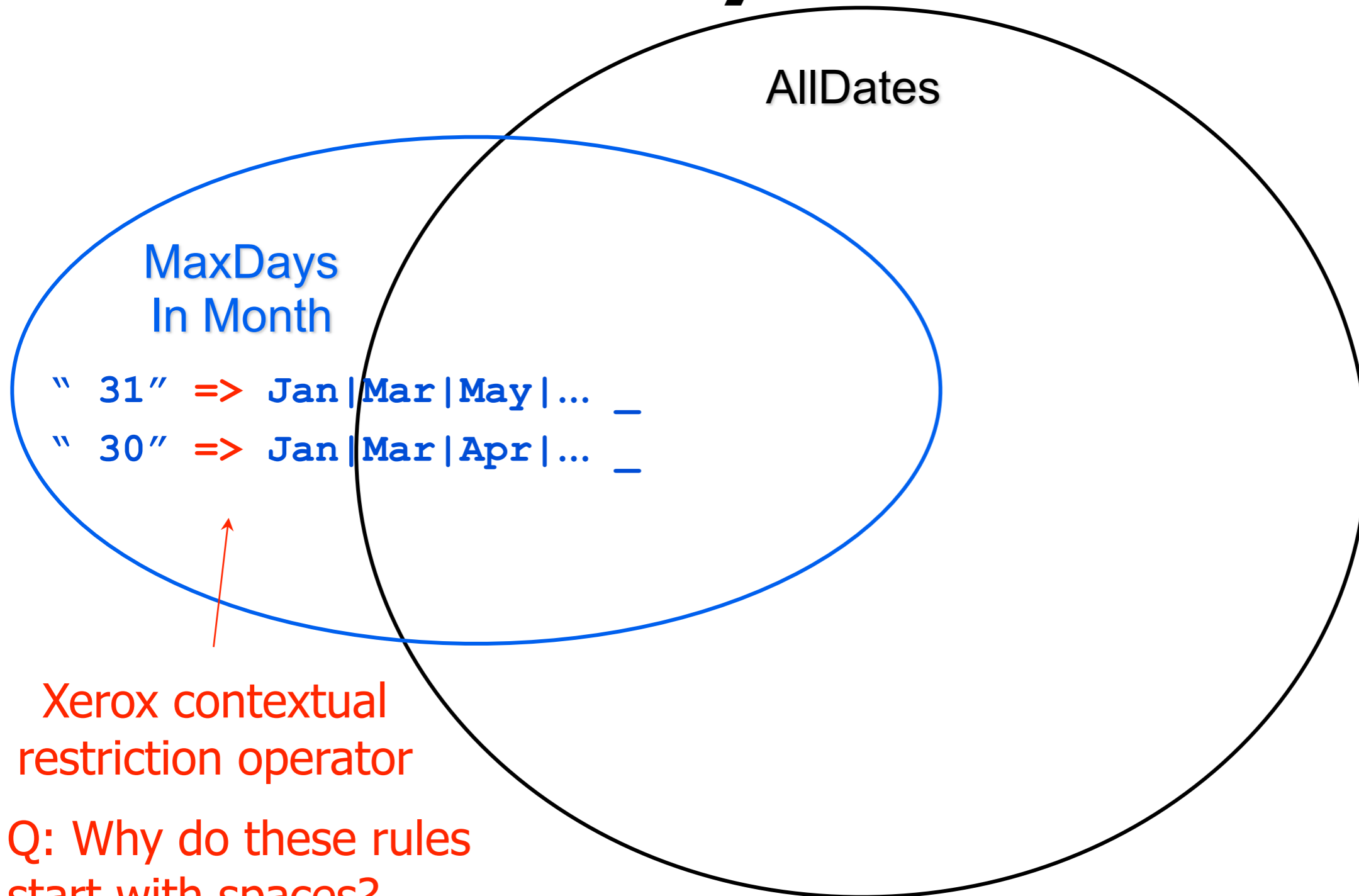

Xerox contextual
restriction operator

Q: Why do these rules
start with spaces?
(And is it enough?)

Refinement by Intersection

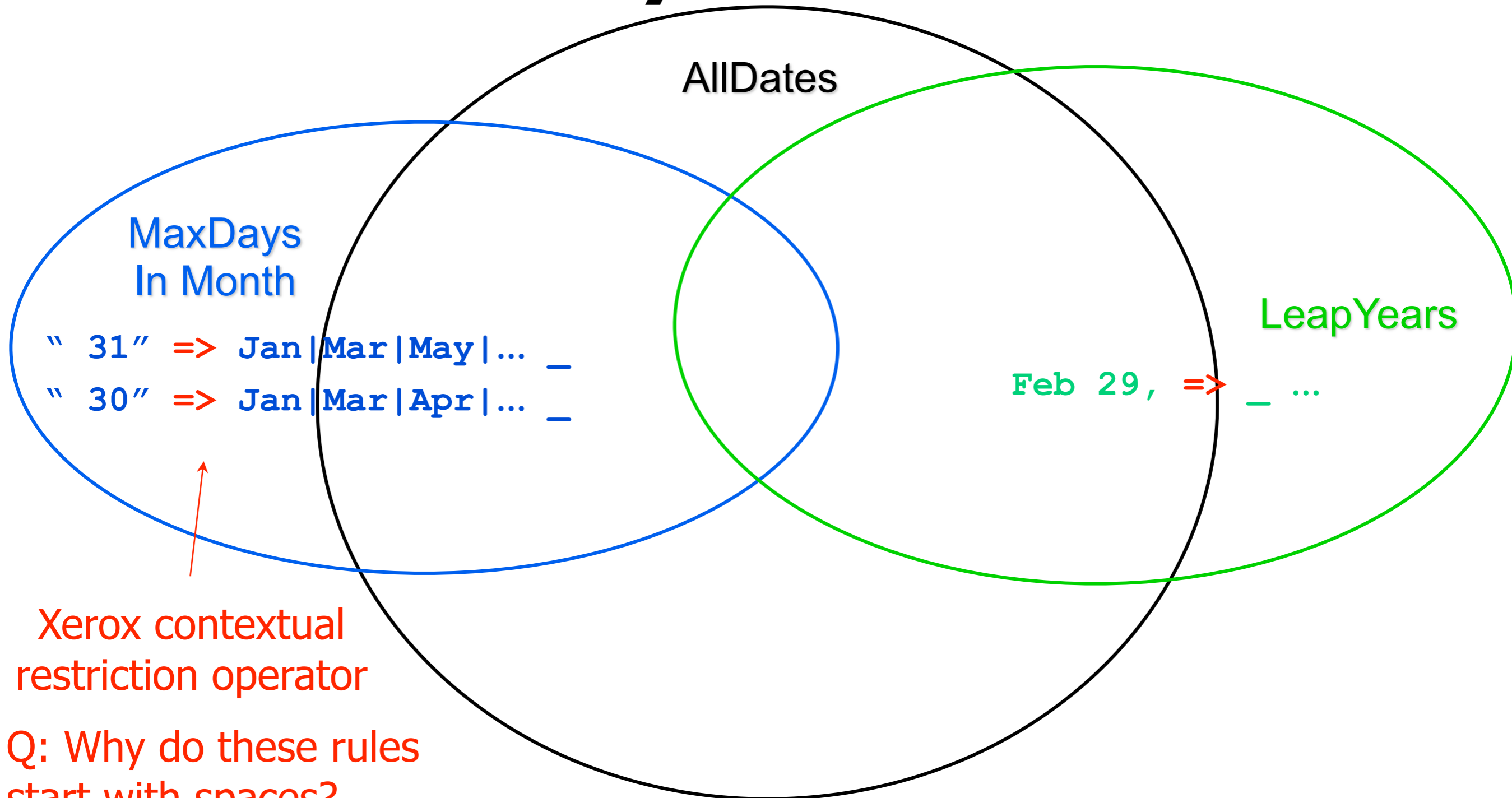

MaxDays
In Month

" 31" => Jan | Mar | May | ... _
" 30" => Jan | Mar | Apr | ... _

LeapYears

Feb 29, => _ ...

Xerox contextual
restriction operator

Q: Why do these rules
start with spaces?
(And is it enough?)

Refinement by Intersection

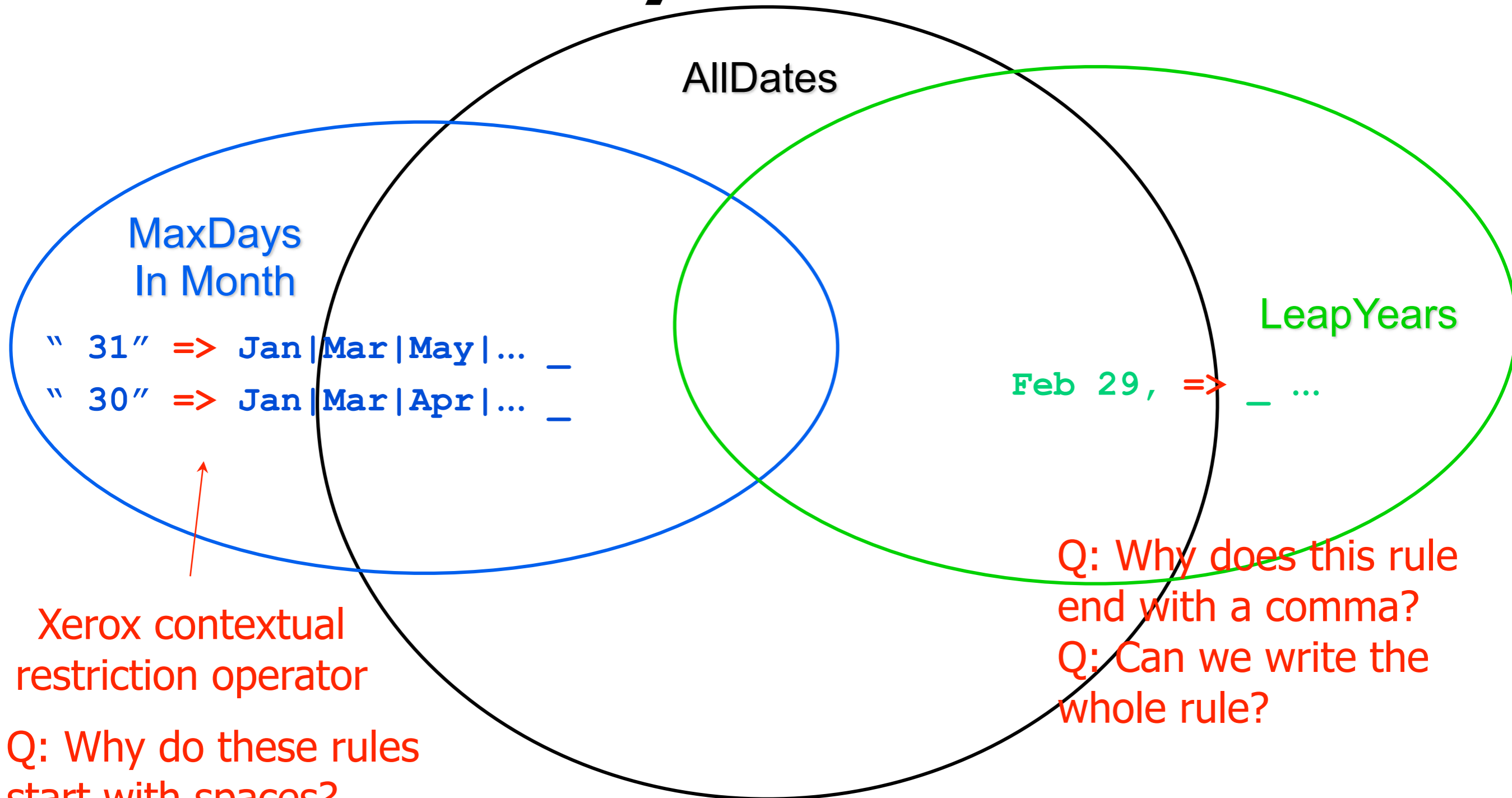

MaxDays
In Month

" 31" => Jan | Mar | May | ... _
" 30" => Jan | Mar | Apr | ... _

LeapYears

Feb 29, => _ ...

Xerox contextual
restriction operator

Q: Why does this rule
end with a comma?
Q: Can we write the
whole rule?

Q: Why do these rules
start with spaces?
(And is it enough?)

Refinement by Intersection

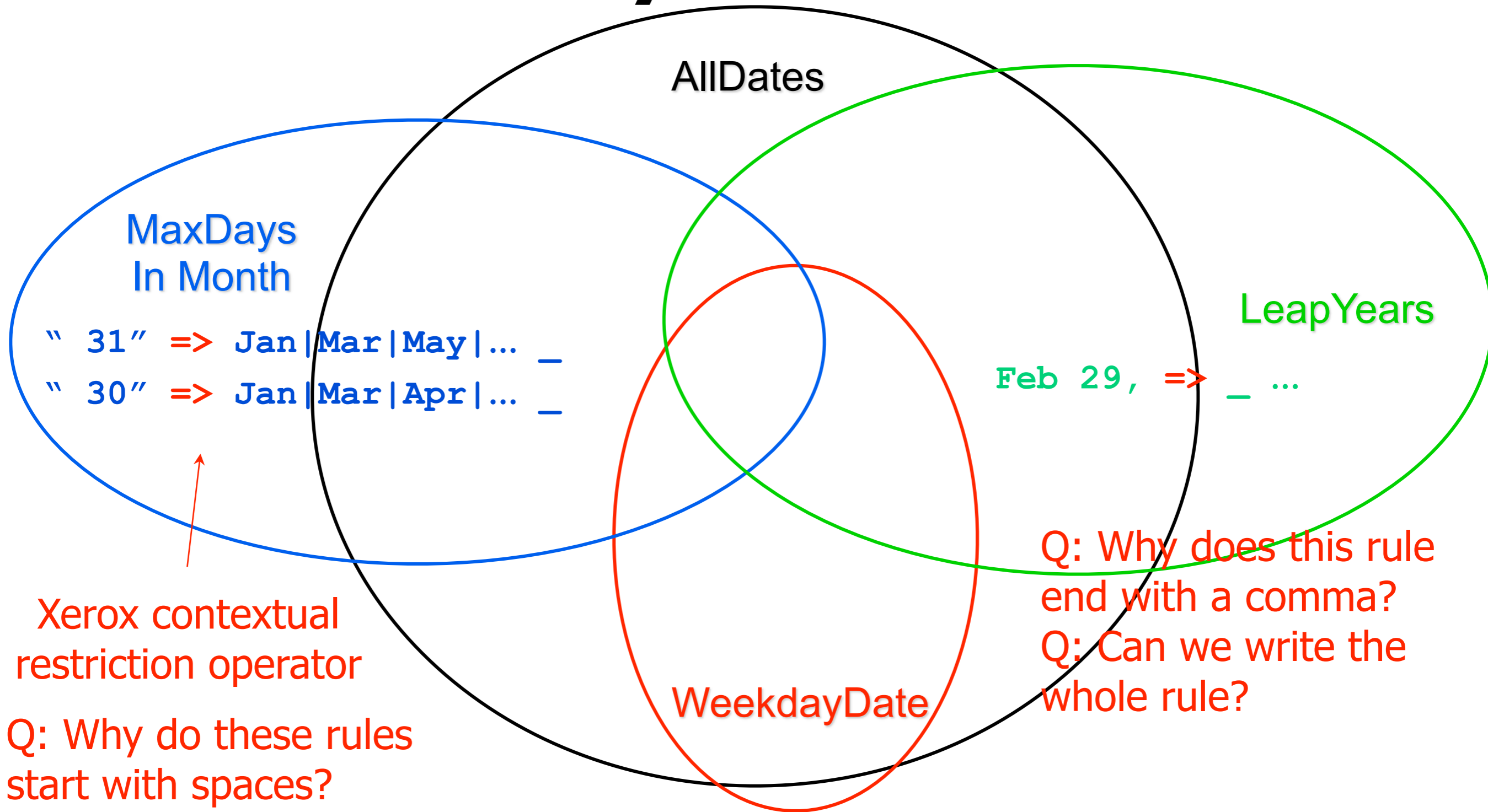

Xerox contextual restriction operator

Q: Why does this rule end with a comma?
Q: Can we write the whole rule?

Q: Why do these rules start with spaces?
(And is it enough?)

Refinement by Intersection

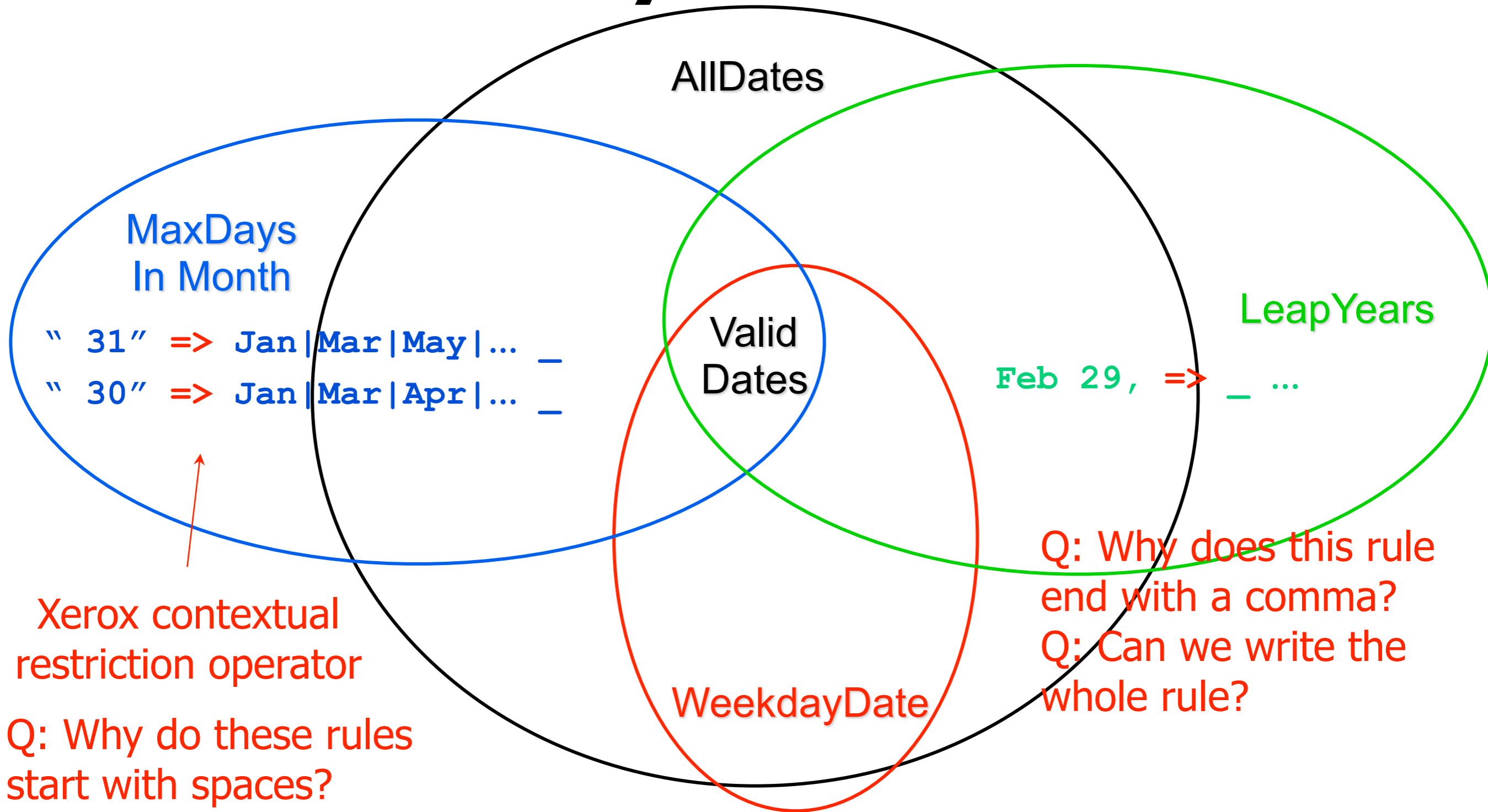

Xerox contextual restriction operator

Q: Why does this rule end with a comma?
Q: Can we write the whole rule?

Q: Why do these rules start with spaces?
(And is it enough?)

Defining Valid Dates

AllDates
&
MaxDaysInMonth
&
LeapYears
&
WeekdayDates

AllDates: 13 states, 96 arcs
29 760 007 date expressions

= ValidDates

ValidDates: 805 states, 6472 arcs
7 307 053 date expressions

Parser for Valid and Invalid Dates

[AllDates - ValidDates] @-> "[ID " ... "]"

ValidDates @-> '[VD " ... "]'

2688 states,
20439 arcs

Today is [VD Tuesday, July 25, 2000],
not [ID Tuesday, July 26, 2000].

valid date

invalid date

Parser for Valid and Invalid Dates

[AllDates - ValidDates] @-> "[ID " ... "]"

ValidDates @-> '[VD " ... "]'

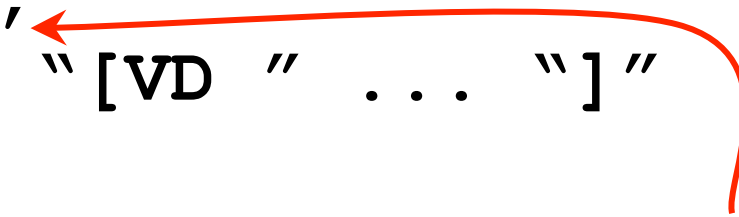

2688 states,
20439 arcs

Comma creates a single FST
that does left-to-right longest
match against either pattern

Today is [VD Tuesday, July 25, 2000],
not [ID Tuesday, July 26, 2000].

valid date

invalid date

More Engineering Applications

More Engineering Applications

- Markup

More Engineering Applications

- Markup
 - Dates, names, places, noun phrases; spelling/grammar errors?

More Engineering Applications

- Markup
 - Dates, names, places, noun phrases; spelling/grammar errors?
 - Hyphenation

More Engineering Applications

- Markup
 - Dates, names, places, noun phrases; spelling/grammar errors?
 - Hyphenation
 - Informative templates for information extraction (FASTUS)

More Engineering Applications

- Markup
 - Dates, names, places, noun phrases; spelling/grammar errors?
 - Hyphenation
 - Informative templates for information extraction (FASTUS)
 - Word segmentation (use probabilities!)

More Engineering Applications

- Markup
 - Dates, names, places, noun phrases; spelling/grammar errors?
 - Hyphenation
 - Informative templates for information extraction (FASTUS)
 - Word segmentation (use probabilities!)
 - Part-of-speech tagging (use probabilities – maybe!)

More Engineering Applications

- Markup
 - Dates, names, places, noun phrases; spelling/grammar errors?
 - Hyphenation
 - Informative templates for information extraction (FASTUS)
 - Word segmentation (use probabilities!)
 - Part-of-speech tagging (use probabilities – maybe!)
- Translation

More Engineering Applications

- Markup
 - Dates, names, places, noun phrases; spelling/grammar errors?
 - Hyphenation
 - Informative templates for information extraction (FASTUS)
 - Word segmentation (use probabilities!)
 - Part-of-speech tagging (use probabilities – maybe!)
- Translation
 - Spelling correction / edit distance

More Engineering Applications

- Markup
 - Dates, names, places, noun phrases; spelling/grammar errors?
 - Hyphenation
 - Informative templates for information extraction (FASTUS)
 - Word segmentation (use probabilities!)
 - Part-of-speech tagging (use probabilities – maybe!)
- Translation
 - Spelling correction / edit distance
 - Phonology, morphology: series of little fixups? constraints?

More Engineering Applications

- Markup
 - Dates, names, places, noun phrases; spelling/grammar errors?
 - Hyphenation
 - Informative templates for information extraction (FASTUS)
 - Word segmentation (use probabilities!)
 - Part-of-speech tagging (use probabilities – maybe!)
- Translation
 - Spelling correction / edit distance
 - Phonology, morphology: series of little fixups? constraints?
 - Speech

More Engineering Applications

- Markup

- Dates, names, places, noun phrases; spelling/grammar errors?
- Hyphenation
- Informative templates for information extraction (FASTUS)
- Word segmentation (use probabilities!)
- Part-of-speech tagging (use probabilities – maybe!)

- Translation

- Spelling correction / edit distance
- Phonology, morphology: series of little fixups? constraints?
- Speech
- Transliteration / back-transliteration

More Engineering Applications

- Markup

- Dates, names, places, noun phrases; spelling/grammar errors?
- Hyphenation
- Informative templates for information extraction (FASTUS)
- Word segmentation (use probabilities!)
- Part-of-speech tagging (use probabilities – maybe!)

- Translation

- Spelling correction / edit distance
- Phonology, morphology: series of little fixups? constraints?
- Speech
- Transliteration / back-transliteration
- Machine translation?

More Engineering Applications

- Markup
 - Dates, names, places, noun phrases; spelling/grammar errors?
 - Hyphenation
 - Informative templates for information extraction (FASTUS)
 - Word segmentation (use probabilities!)
 - Part-of-speech tagging (use probabilities – maybe!)
- Translation
 - Spelling correction / edit distance
 - Phonology, morphology: series of little fixups? constraints?
 - Speech
 - Transliteration / back-transliteration
 - Machine translation?
- Learning ...

FASTUS – Information Extraction

Appelt et al, 1992-?

Input: Bridgestone Sports Co. said Friday it has set up a joint venture in Taiwan with a local concern and a Japanese trading house to produce golf clubs to be shipped to Japan. The joint venture, Bridgestone Sports Taiwan Co., capitalized at 20 million new Taiwan dollars, will start production in January 1990 with ...

Output:

Relationship:

TIE-UP

Entities:

"Bridgestone Sports Co."

"A local concern"

"A Japanese trading house"

Joint Venture Company:

"Bridgestone Sports Taiwan Co."

Amount:

NT\$20000000

FASTUS: Successive Markups

(details on subsequent slides)

Tokenization

.0.

Multiwords

.0.

Basic phrases (noun groups, verb groups ...)

.0.

Complex phrases

.0.

Semantic Patterns

.0.

Merging different references

FASTUS: Tokenization

- Spaces, hyphens, etc.
- wouldn't → would not
- their → them 's
- company. → company .
but
Co. → Co.

FASTUS: Multiwords

- "set up"
- "joint venture"
- "San Francisco Symphony Orchestra,"
"Canadian Opera Company"
- ... use a specialized regexp to match musical groups.
- ... what kind of regexp would match company names?

FASTUS : Basic phrases

Output looks like this (no nested brackets!):

... [NG it] [VG had set_up] [NP a joint_venture] [Prep in] ...

Company Name: Bridgestone Sports Co.

Verb Group: said

Noun Group: Friday

Noun Group: it

Verb Group: had set up

Noun Group: a joint venture

Preposition: in

Location: Taiwan

Preposition: with

Noun Group: a local concern

FASTUS: Noun Groups

Build FSA to recognize phrases like

approximately 5 kg

more than 30 people

the newly elected president

the largest leftist political force

a government and commercial project

Use the FSA for left-to-right longest-match markup

What does FSA look like? See next slide ...

FASTUS: Noun Groups

Described with a kind of non-recursive CFG ...

(a regexp can include names that stand for other regexps)

NG → Pronoun | Time-NP | Date-NP

NG → (Det) (Adjs) HeadNouns

...

Adjs → sequence of adjectives maybe with commas,
conjunctions, adverbs

...

Det → DetNP | DetNonNP

DetNP → detailed expression to match "the only five, another
three, this, many, hers, all, the most ..."

...

FASTUS: Semantic patterns

BusinessRelationship =

NounGroup(Company/ies) VerbGroup(Set-up)

NounGroup(JointVenture) with NounGroup(Company/ies)

| ...

ProductionActivity =

VerbGroup(Produce) NounGroup(Product)

NounGroup(Company/ies) → NounGroup & ...

is made easy by the processing done at a previous level

Use this for spotting references to put in the database.

Weighted FSMs

Function from strings to ...

Acceptors (FSAs)

Transducers (FSTs)

Unweighted

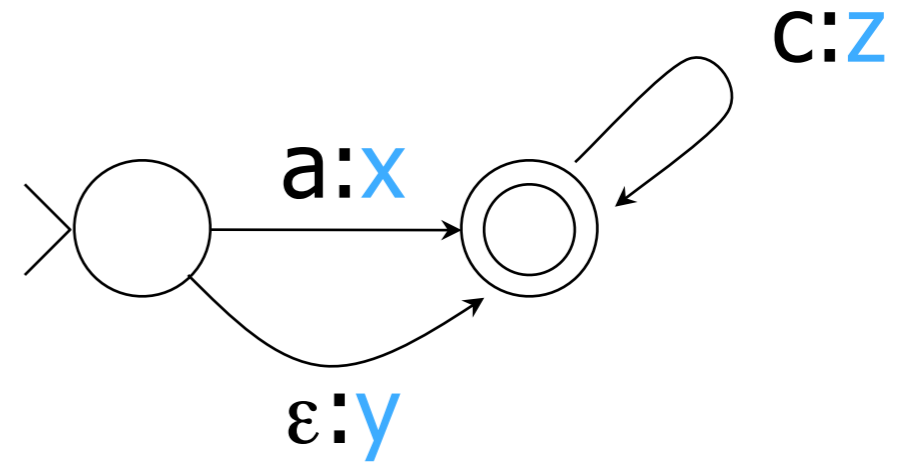
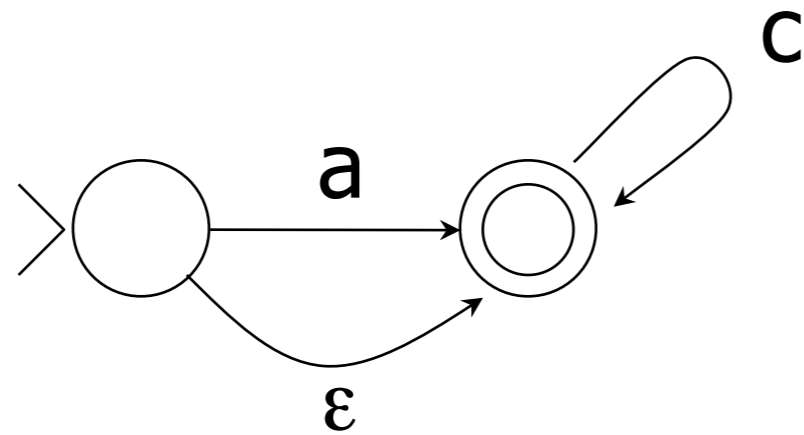

Weighted

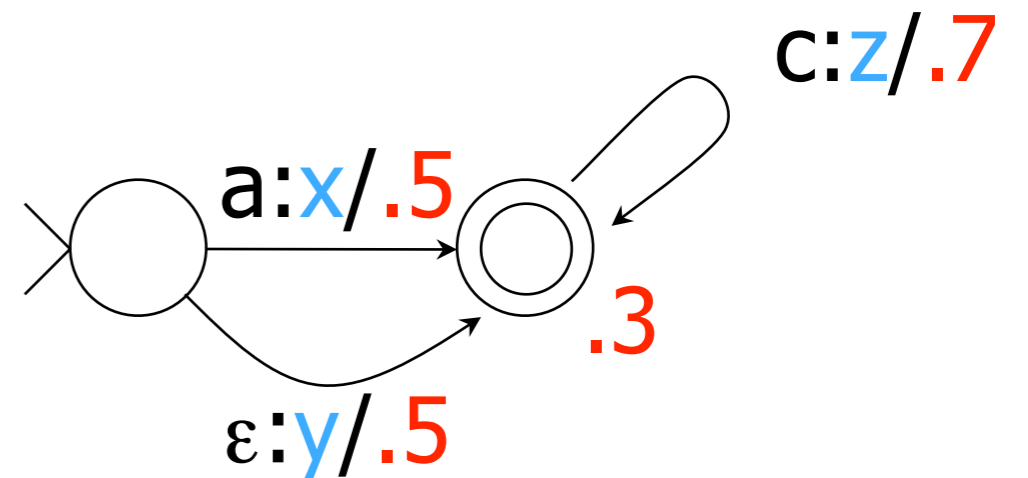
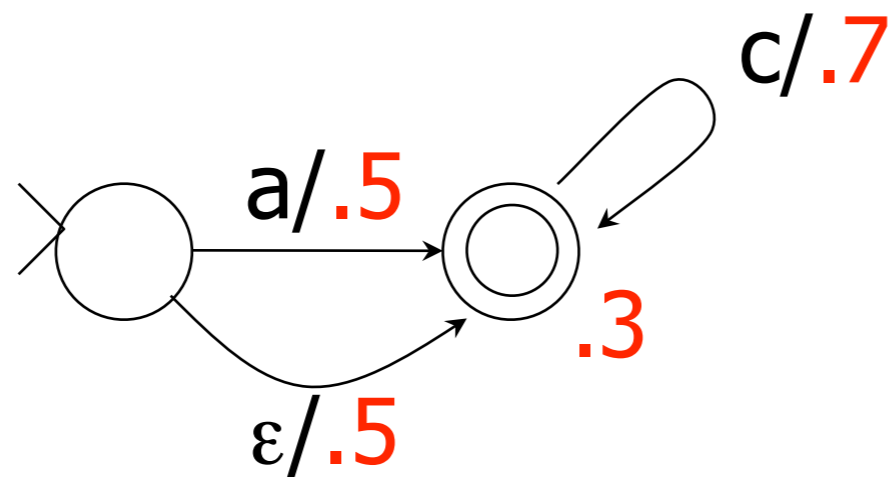

Function from strings to ...

Acceptors (FSAs)

Transducers (FSTs)

Unweighted

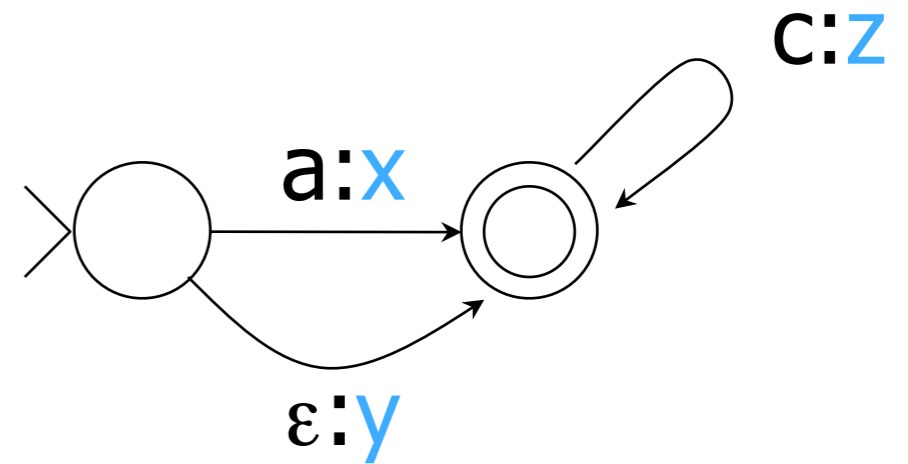
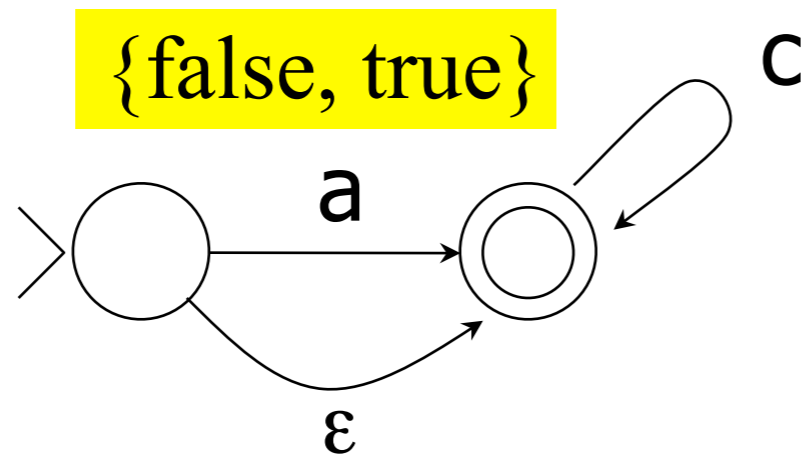

Weighted

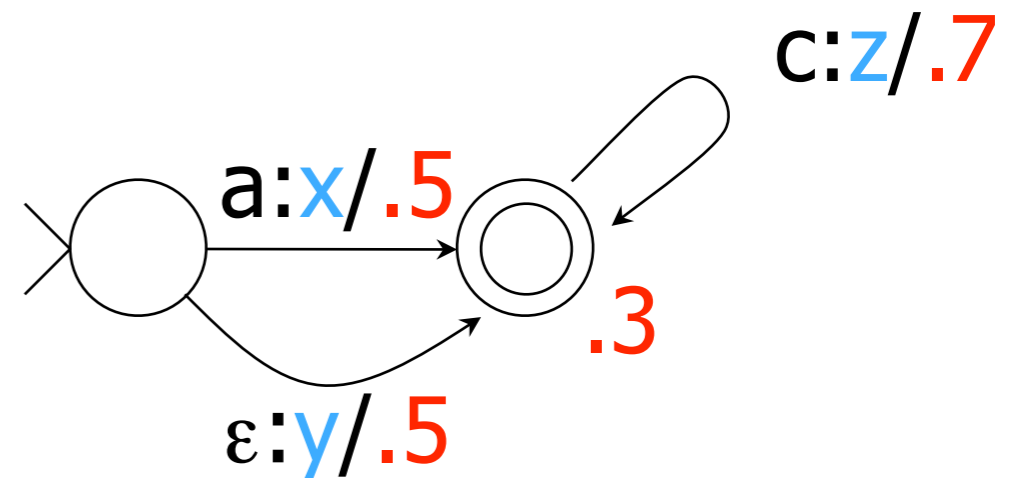
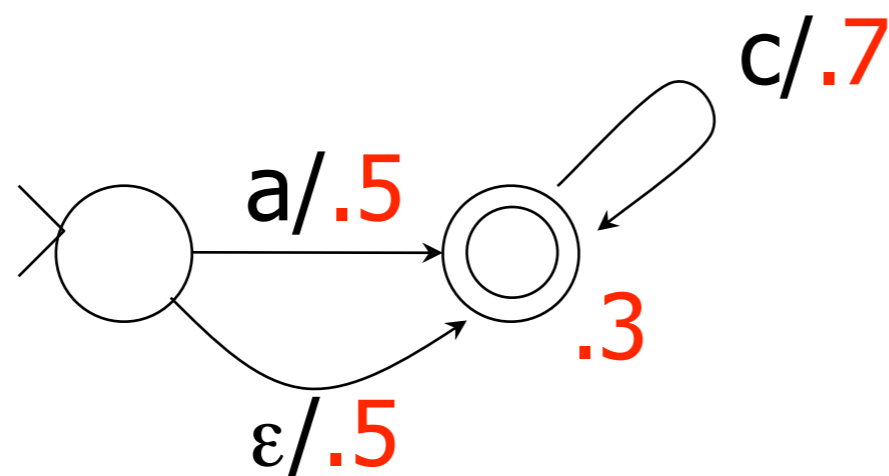

Function from strings to ...

Acceptors (FSAs)

Transducers (FSTs)

Unweighted

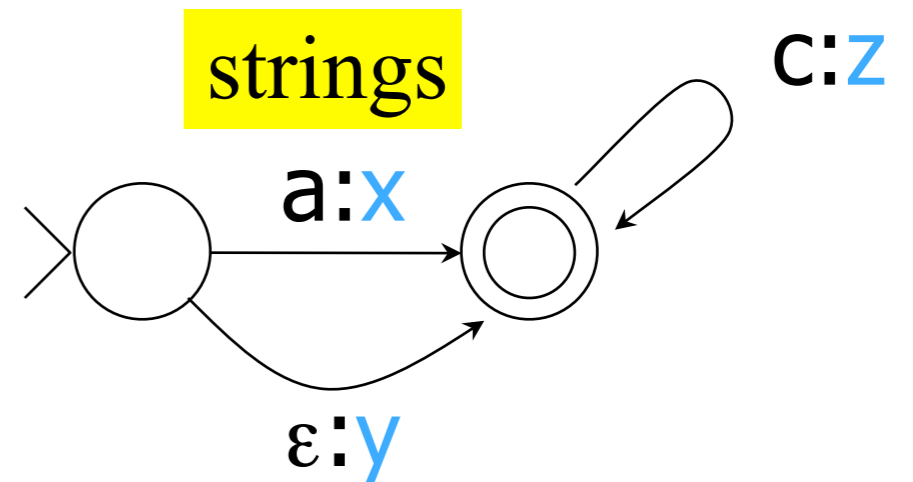
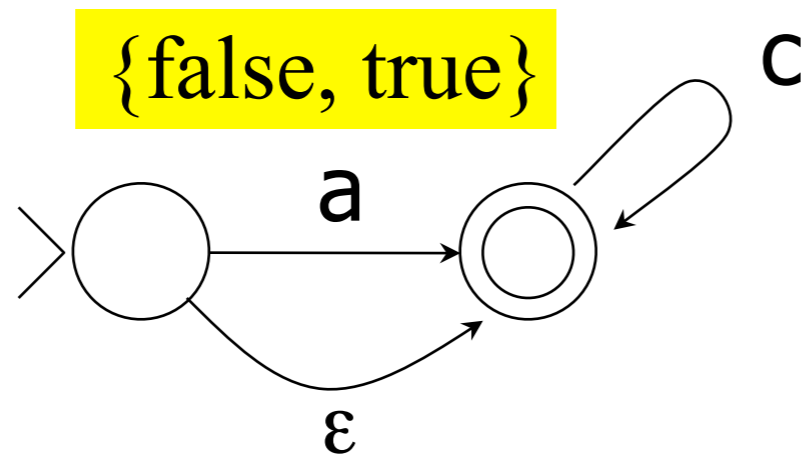

Weighted

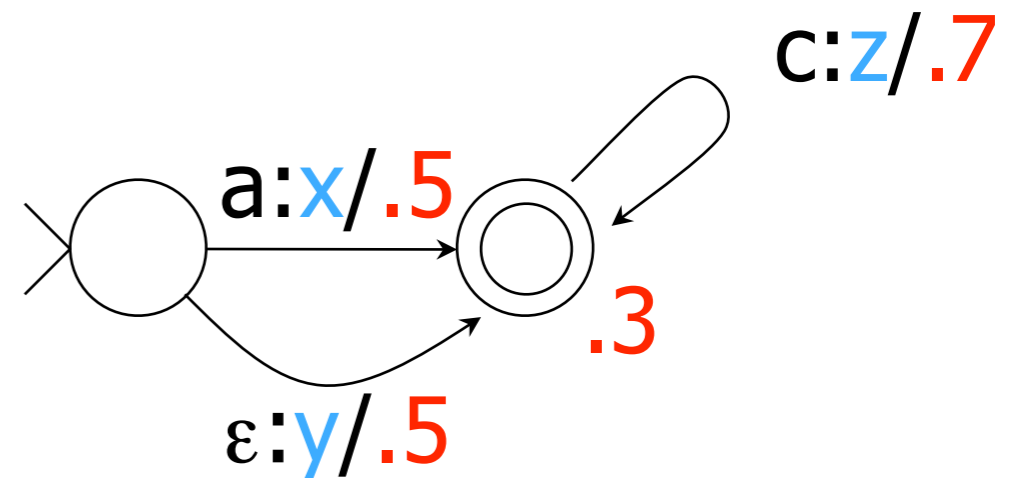
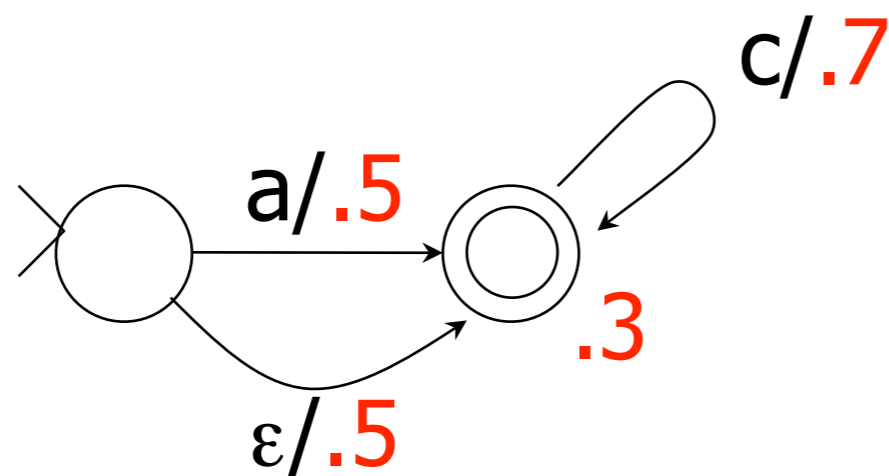

Function from strings to ...

Acceptors (FSAs)

Transducers (FSTs)

Unweighted

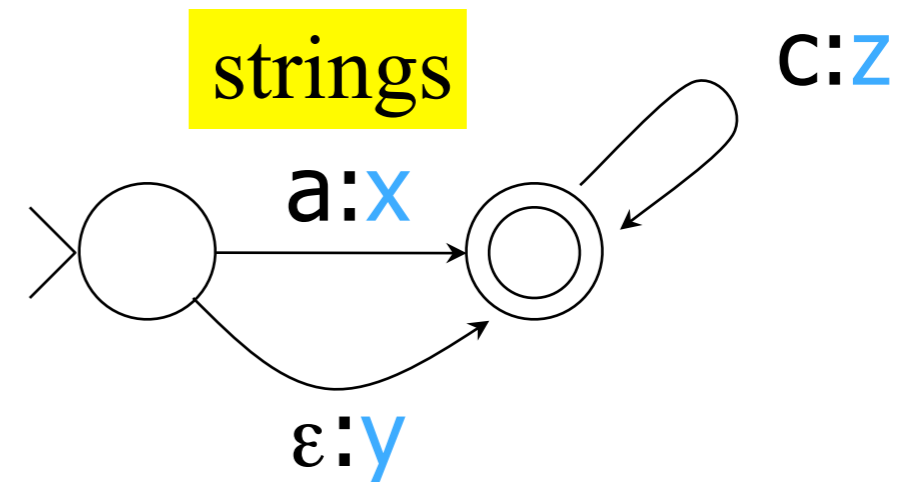
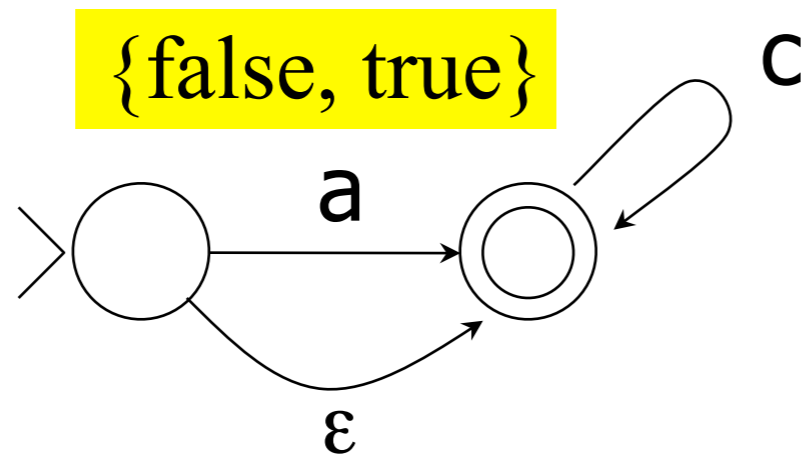

Weighted

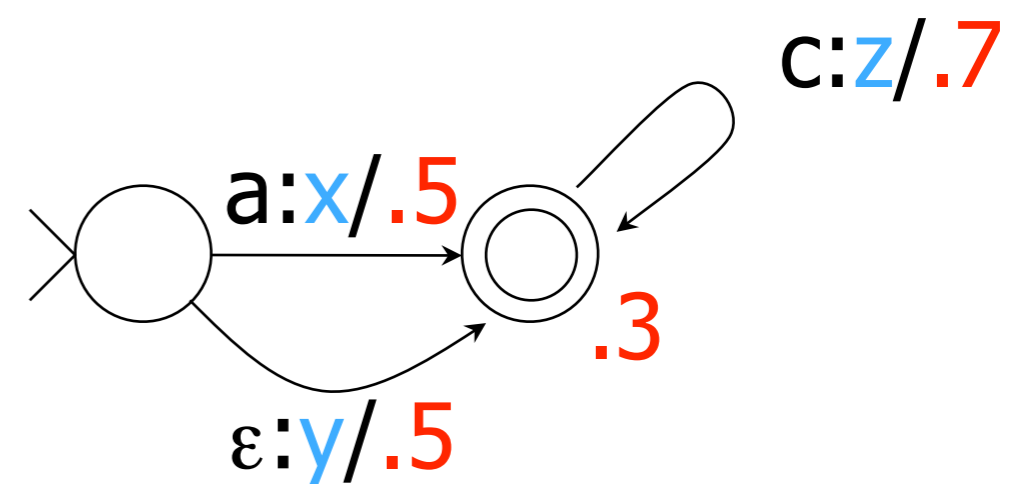
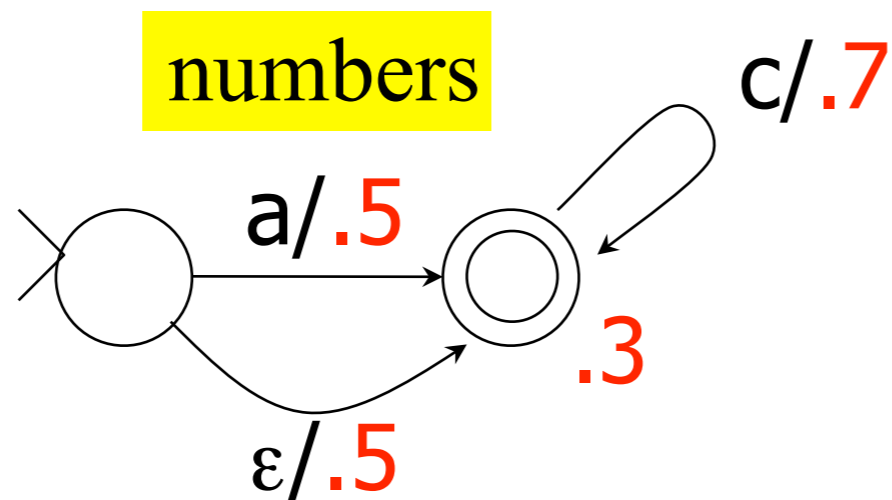

Function from strings to ...

Acceptors (FSAs)

Transducers (FSTs)

Unweighted

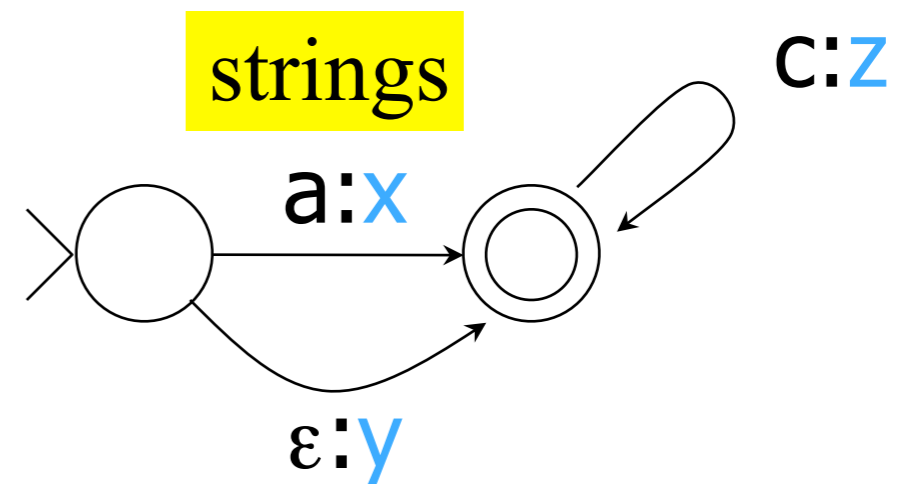
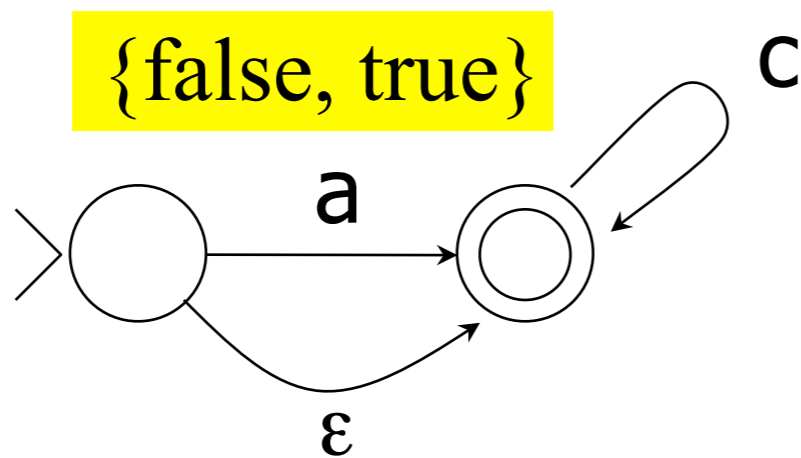

Weighted

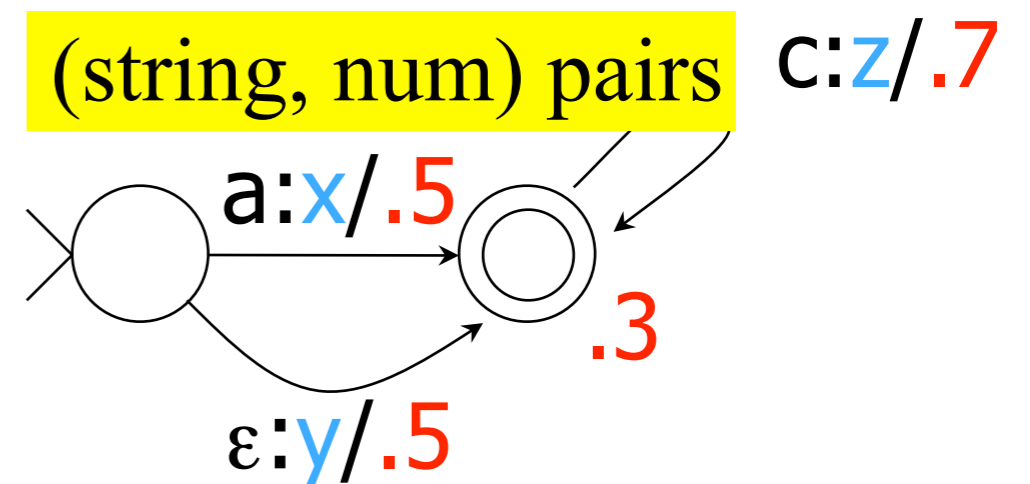
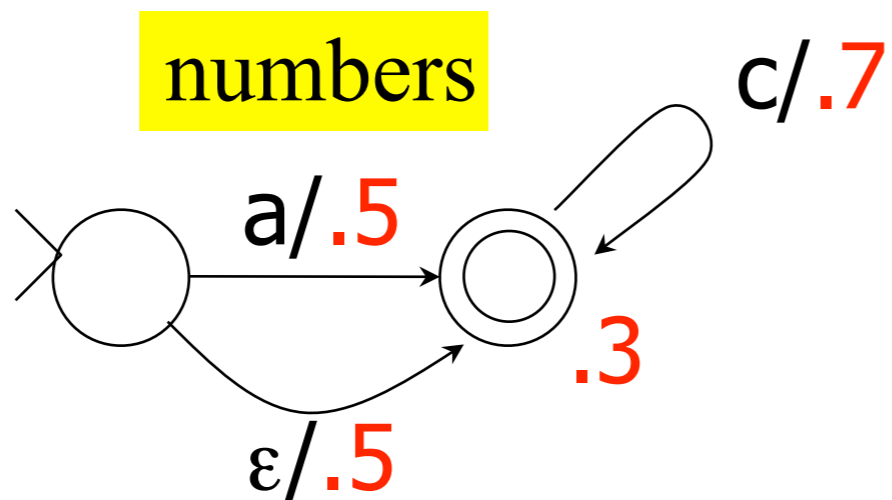

Weighted Relations

- If we have a language [or relation], we can ask it: Do you contain this string [or string pair]?
- If we have a **weighted** language [or relation], we ask: What **weight** do you assign to this string [or string pair]?
- Pick a semiring: all our **weights** will be in that semiring.
 - **What?!**

Semirings

	Set	\oplus	\otimes	0	1
Prob	\mathbb{R}^+	+	x	0	1
Max	\mathbb{R}^+	max	x	0	1
Log	$\mathbb{R} \cup \{\pm\infty\}$	log+	+	$-\infty$	0
“Tropical”	$\mathbb{R} \cup \{\pm\infty\}$	max	+	$-\infty$	0
Shortest path	$\mathbb{R} \cup \{\pm\infty\}$	min	+	∞	0
Boolean	$\{0, 1\}$	\vee	\wedge	F	T
String	$\Sigma^* \cup \{\infty\}$	longest common prefix	concat	∞	ε

Weighted Relations

- If we have a language [or relation], we can ask it: Do you contain this string [or string pair]?
- If we have a **weighted** language [or relation], we ask: What **weight** do you assign to this string [or string pair]?
- Pick a semiring: all our **weights** will be in that semiring.
 - **Don't panic!** We will cover this again when we get to HMMs and parsing.
 - The unweighted case is the boolean semiring {true, false}.
 - If a string is not in the language, it has weight $\textcircled{0}$.
 - If an FST or regular expression can choose among multiple ways to match, use $\textcircled{+}$ to combine the weights of the different choices.
 - If an FST or regular expression matches by matching multiple substrings, use $\textcircled{\times}$ to combine those different matches.
 - Remember, $\textcircled{+}$ is like "or" and $\textcircled{\times}$ is like "and"!

Which Semiring Operators are Needed?

	concatenation	EF
$*$ $+$	iteration	E^*, E^+
$ $	union	$E F$
\sim \setminus $-$	complementation, minus	$\sim E, \setminus x, E-F$
$\&$	intersection	$E \& F$
$.x.$	crossproduct	$E .x. F$
$.o.$	composition	$E .o. F$
$.u$	upper (input) language	$E.u$ "domain"
$.l$	lower (output) language	$E.l$ "range"

Which Semiring Operators are Needed?

	concatenation		EF
$*$ $+$	iteration		E^*, E^+
$ $	union	\oplus to sum over 2 choices	$E F$
\sim \setminus $-$	complementation, minus		$\sim E, \setminus x, E-F$
$\&$	intersection		$E \& F$
$\cdot x \cdot$	crossproduct		$E \cdot x \cdot F$
$\cdot o \cdot$	composition		$E \cdot o \cdot F$
$\cdot u$	upper (input) language		$E \cdot u$ "domain"
$\cdot l$	lower (output) language		$E \cdot l$ "range"

Which Semiring Operators are Needed?

	concatenation		EF
$*$ $+$	iteration		E^*, E^+
$ $	union	\oplus to sum over 2 choices	$E F$
\sim \setminus $-$	complementation, minus		$\sim E, \setminus x, E-F$
$\&$	intersection	} \otimes to combine the matches against E and F	$E \& F$
$\cdot x \cdot$	crossproduct		$E \cdot x \cdot F$
$\cdot o \cdot$	composition		$E \cdot o \cdot F$
$\cdot u$	upper (input) language		$E \cdot u$ "domain"
$\cdot l$	lower (output) language		$E \cdot l$ "range"

Common Regular Expression Operators (in XFST notation)

| union \oplus to sum over 2 choices $E | F$

$$E | F = \{w: w \in E \text{ or } w \in F\} = E \cup F$$

- Weighted case: Let's write $E(w)$ to denote the weight of w in the weighted language E .

$$(E|F)(w) = E(w) \oplus F(w)$$

Which Semiring Operators are Needed?

	concatenation		EF
$*$ $+$	iteration		E^*, E^+
$ $	union	\oplus to sum over 2 choices	$E F$
\sim \setminus $-$	complementation, minus		$\sim E, \setminus x, E-F$
$\&$	intersection		$E \& F$
$\cdot x \cdot$	crossproduct		$E \cdot x \cdot F$
$\cdot o \cdot$	composition		$E \cdot o \cdot F$
$\cdot u$	upper (input) language		$E \cdot u$ "domain"
$\cdot l$	lower (output) language		$E \cdot l$ "range"

Which Semiring Operators are Needed?

	concatenation		EF
$*$ $+$	iteration		E^*, E^+
$ $	union	\oplus to sum over 2 choices	$E F$
\sim \setminus $-$	complementation, minus		$\sim E, \setminus x, E-F$
$\&$	intersection	\otimes to combine the matches against E and F	$E \& F$
$\cdot x \cdot$	crossproduct		$E \cdot x \cdot F$
$\cdot o \cdot$	composition		$E \cdot o \cdot F$
$\cdot u$	upper (input) language		$E \cdot u$ "domain"
$\cdot l$	lower (output) language		$E \cdot l$ "range"

Which Semiring Operators are Needed?

	concatenation	} need both \oplus and \otimes	EF
$*$ $+$	iteration		E^*, E^+
$ $	union	\oplus to sum over 2 choices	$E F$
\sim \setminus $-$	complementation, minus		$\sim E, \setminus x, E-F$
$\&$	intersection	} \otimes to combine the matches against E and F	$E \& F$
$\cdot x \cdot$	crossproduct		$E \cdot x \cdot F$
$\cdot o \cdot$	composition		$E \cdot o \cdot F$
$\cdot u$	upper (input) language		$E \cdot u$ "domain"
$\cdot l$	lower (output) language		$E \cdot l$ "range"

Which Semiring Operators are Needed?

- +
 - concatenation
 - iteration
- need both \oplus and \otimes
- EF
 $E^*, E+$

$$EF = \{ef : e \in E, f \in F\}$$

- Weighted case must match two things (\otimes), but there's a choice (\oplus) about which two things:

$$(EF)(w) = \bigoplus_{\substack{e,f \text{ such} \\ \text{that } w=ef}} (E(e) \otimes F(f))$$

Which Semiring Operators are Needed?

	concatenation	} need both \oplus and \otimes	EF
$*$ $+$	iteration		E^*, E^+
$ $	union	\oplus to sum over 2 choices	$E F$
\sim \setminus $-$	complementation, minus		$\sim E, \setminus x, E-F$
$\&$	intersection	} \otimes to combine the matches against E and F	$E \& F$
$\cdot x \cdot$	crossproduct		$E \cdot x \cdot F$
$\cdot o \cdot$	composition		$E \cdot o \cdot F$
$\cdot u$	upper (input) language		$E \cdot u$ "domain"
$\cdot l$	lower (output) language		$E \cdot l$ "range"

Which Semiring Operators are Needed?

	concatenation		EF
$*$	iteration	$\left. \begin{array}{l} \text{need both } \oplus \text{ and} \\ \otimes \end{array} \right\}$	E^*, E^+
$+$			
$ $	union	\oplus to sum over 2 choices	$E F$
\sim	complementation, minus		$\sim E, \setminus x, E-F$
$\&$	intersection	$\left. \begin{array}{l} \otimes \text{ to combine} \\ \text{the matches} \\ \text{against } E \text{ and } F \end{array} \right\}$	$E \& F$
$\cdot x \cdot$	crossproduct		
$\cdot o \cdot$	composition	both \oplus and \otimes (why?)	$E \cdot o \cdot F$
$\cdot u$	upper (input) language		$E \cdot u$ "domain"
$\cdot l$	lower (output) language		$E \cdot l$ "range"

Which Semiring Operators are Needed?

	concatenation		EF
$*$	iteration	$\left. \begin{array}{l} \text{need both } \oplus \text{ and } \\ \otimes \end{array} \right\}$	E^*, E^+
$+$			
$ $	union	\oplus to sum over 2 choices	$E F$
\sim	complementation, minus		$\sim E, \setminus x, E-F$
$\&$	intersection	$\left. \begin{array}{l} \otimes \text{ to combine} \\ \text{the matches} \\ \text{against } E \text{ and } F \end{array} \right\}$	$E \& F$
$\cdot x \cdot$	crossproduct		
$\cdot o \cdot$	composition	both \oplus and \otimes (why?)	$E \cdot o \cdot F$
$\cdot u$	upper (input) language	\oplus	$E \cdot u$ "domain"
$\cdot l$	lower (output) language	\oplus	$E \cdot l$ "range"

Definition of FSTs

Definition of FSTs

- [Red material shows differences from FSAs.]

Definition of FSTs

- [Red material shows differences from FSAs.]
- Simple view:
 - An FST is simply a finite directed graph, with some labels.
 - It has a designated initial state and a set of final states.
 - Each edge is labeled with an "upper string" (in Σ^*).

Definition of FSTs

- [Red material shows differences from FSAs.]
- Simple view:
 - An FST is simply a finite directed graph, with some labels.
 - It has a designated initial state and a set of final states.
 - Each edge is labeled with an "upper string" (in Σ^*).
 - Each edge is also labeled with a "lower string" (in Δ^*).
 - [Upper/lower are sometimes regarded as input/output.]

Definition of FSTs

- [Red material shows differences from FSAs.]
- Simple view:
 - An FST is simply a finite directed graph, with some labels.
 - It has a designated initial state and a set of final states.
 - Each edge is labeled with an "upper string" (in Σ^*).
 - Each edge is also labeled with a "lower string" (in Δ^*).
 - [Upper/lower are sometimes regarded as input/output.]
 - Each edge and final state is also labeled with a semiring weight.

Definition of FSTs

- [Red material shows differences from FSAs.]
- Simple view:
 - An FST is simply a finite directed graph, with some labels.
 - It has a designated initial state and a set of final states.
 - Each edge is labeled with an "upper string" (in Σ^*).
 - Each edge is also labeled with a "lower string" (in Δ^*).
 - [Upper/lower are sometimes regarded as input/output.]
 - Each edge and final state is also labeled with a semiring weight.
- More traditional definition specifies an FST via these:
 - a state set Q
 - initial state i
 - set of final states F
 - input alphabet Σ (also define Σ^* , Σ^+ , $\Sigma^?$)
 - output alphabet Δ

Definition of FSTs

- [Red material shows differences from FSAs.]
- Simple view:
 - An FST is simply a finite directed graph, with some labels.
 - It has a designated initial state and a set of final states.
 - Each edge is labeled with an "upper string" (in Σ^*).
 - Each edge is also labeled with a "lower string" (in Δ^*).
 - [Upper/lower are sometimes regarded as input/output.]
 - Each edge and final state is also labeled with a semiring weight.
- More traditional definition specifies an FST via these:
 - a state set Q
 - initial state i
 - set of final states F
 - input alphabet Σ (also define Σ^* , Σ^+ , $\Sigma^?$)
 - output alphabet Δ
 - transition function $d: Q \times \Sigma^? \rightarrow 2^Q$

Definition of FSTs

- [Red material shows differences from FSAs.]
- Simple view:
 - An FST is simply a finite directed graph, with some labels.
 - It has a designated initial state and a set of final states.
 - Each edge is labeled with an "upper string" (in Σ^*).
 - Each edge is also labeled with a "lower string" (in Δ^*).
 - [Upper/lower are sometimes regarded as input/output.]
 - Each edge and final state is also labeled with a semiring weight.
- More traditional definition specifies an FST via these:
 - a state set Q
 - initial state i
 - set of final states F
 - input alphabet Σ (also define Σ^* , Σ^+ , $\Sigma^?$)
 - output alphabet Δ
 - transition function $d: Q \times \Sigma^? \rightarrow 2^Q$
 - output function $s: Q \times \Sigma^? \times Q \rightarrow \Delta^?$

How to implement?

	concatenation	EF
$*$ $+$	iteration	E^*, E^+
$ $	union	$E F$
\sim \setminus $-$	complementation, minus	$\sim E, \setminus x, E-F$
$\&$	intersection	$E \& F$
$\cdot x \cdot$	crossproduct	$E \cdot x \cdot F$
$\cdot o \cdot$	composition	$E \cdot o \cdot F$
$\cdot u$	upper (input) language	$E \cdot u$ "domain"
$\cdot l$	lower (output) language	$E \cdot l$ "range"

Concatenation

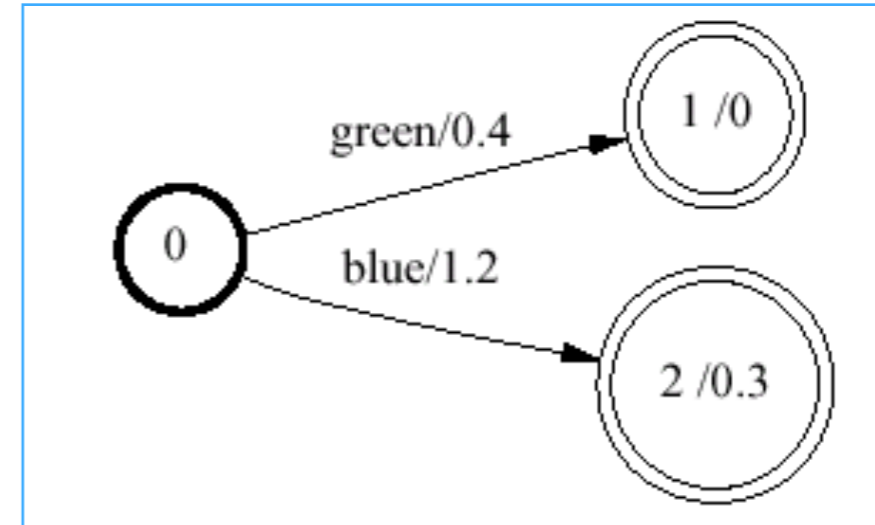
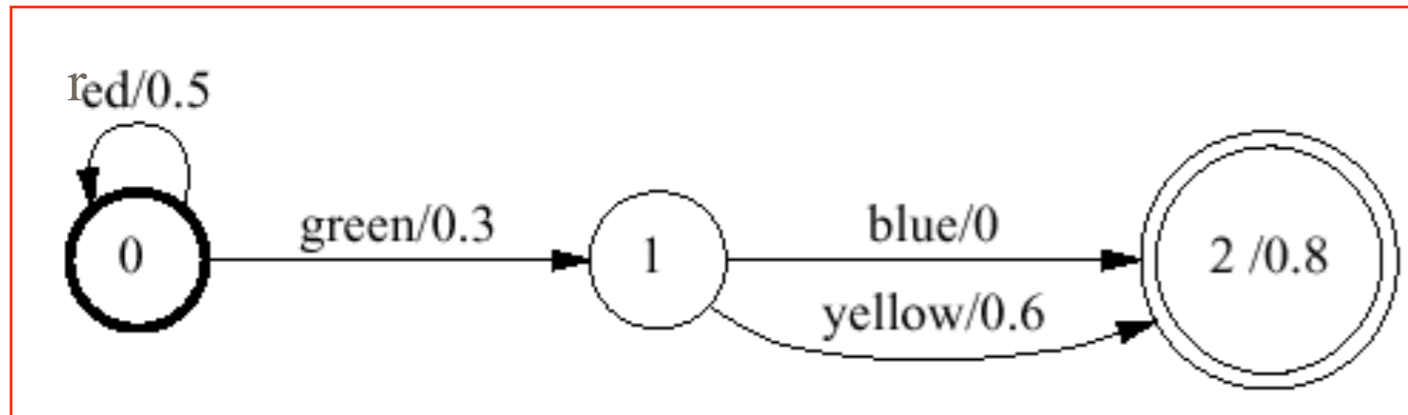

Concatenation

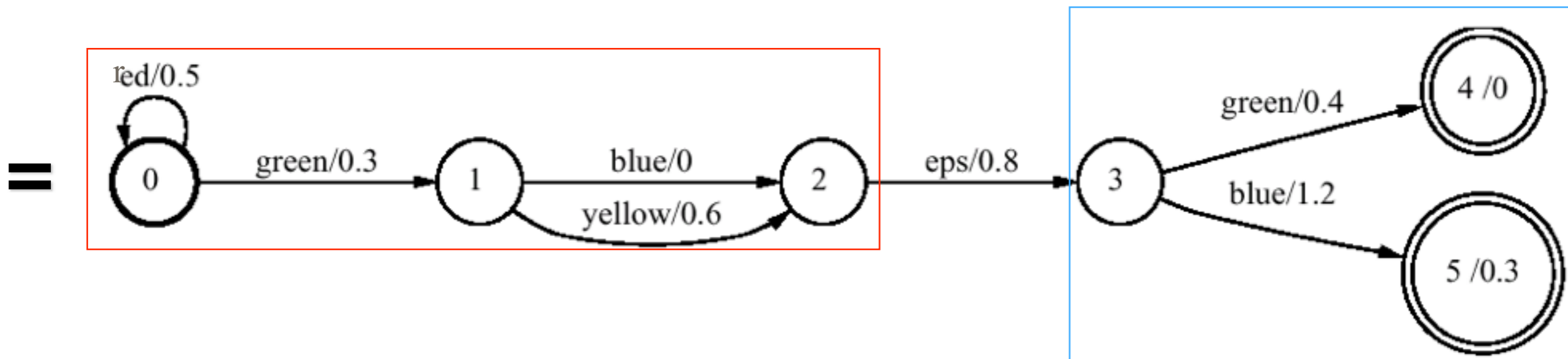
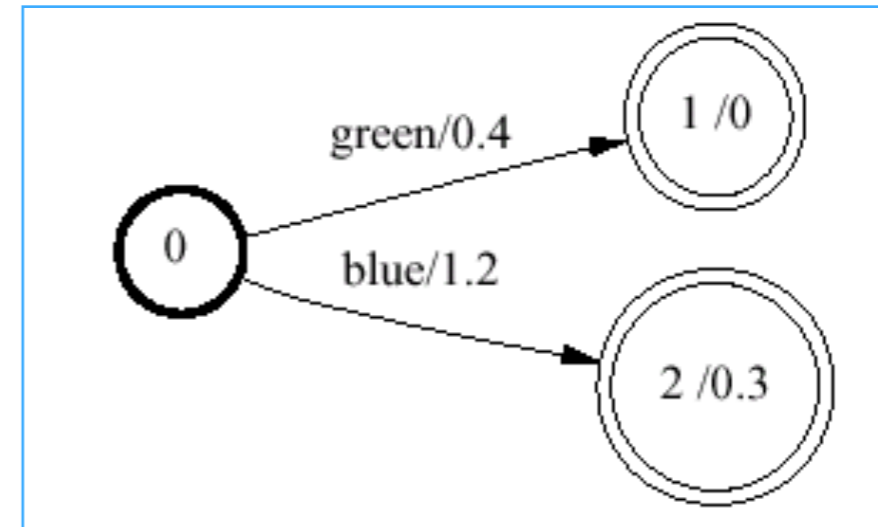
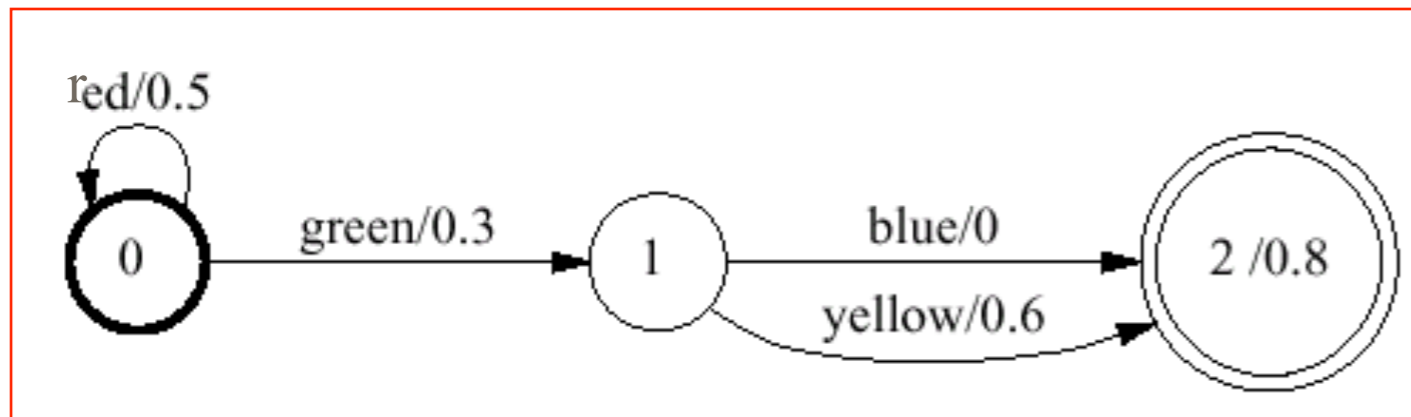

Union

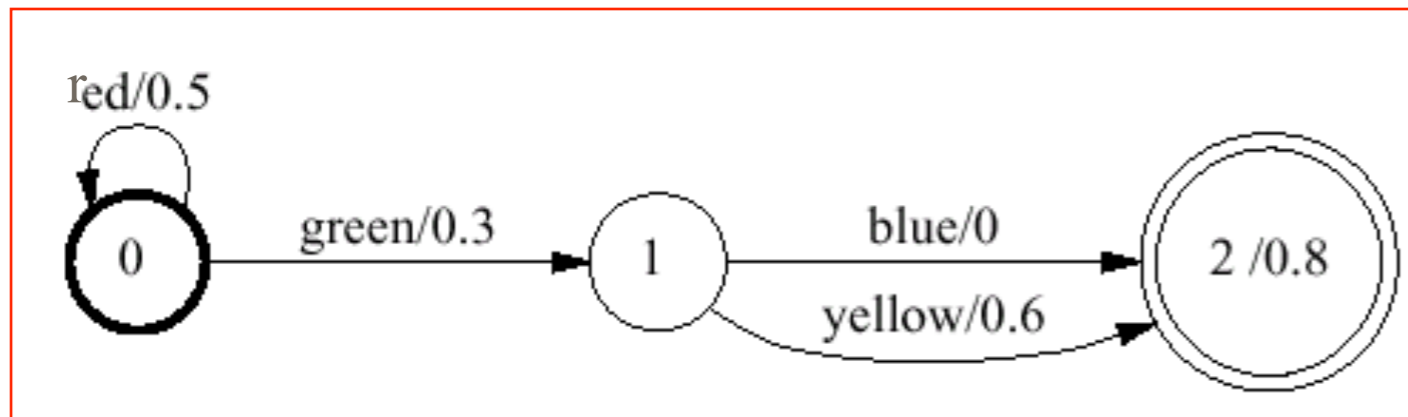

|

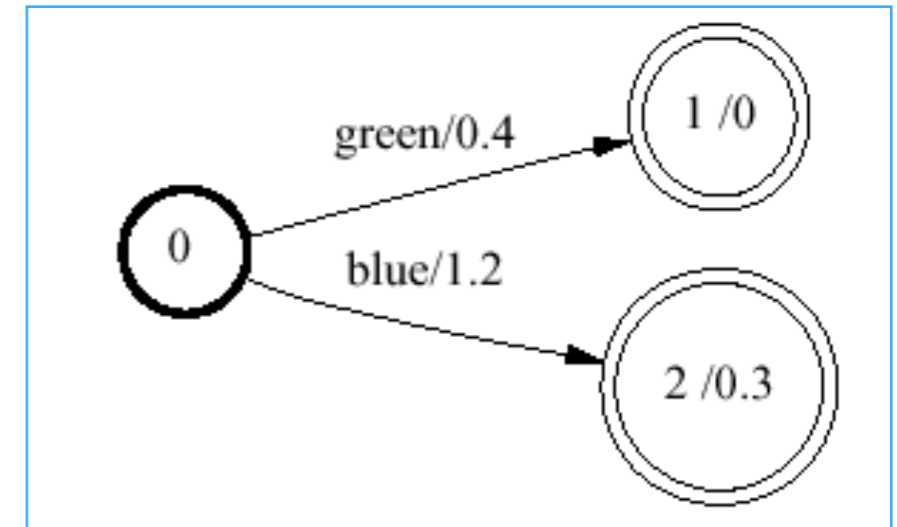

Union

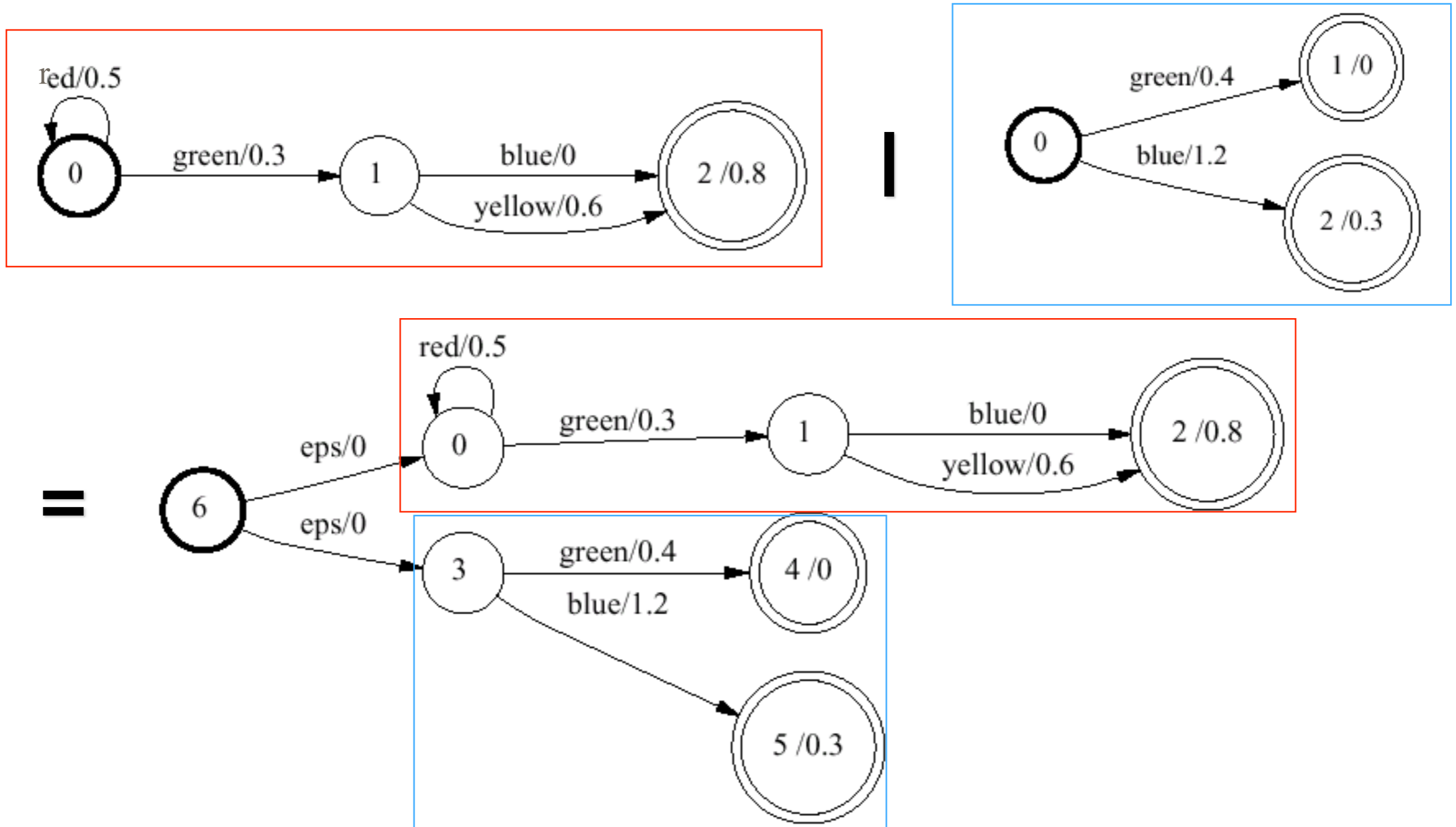

Closure (this example has outputs too)

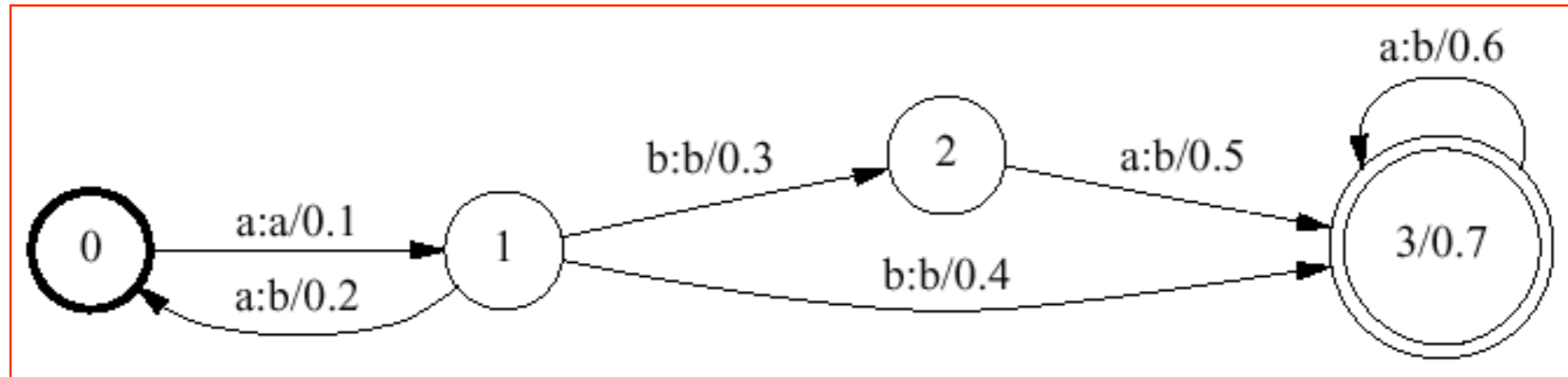

*

Closure (this example has outputs too)

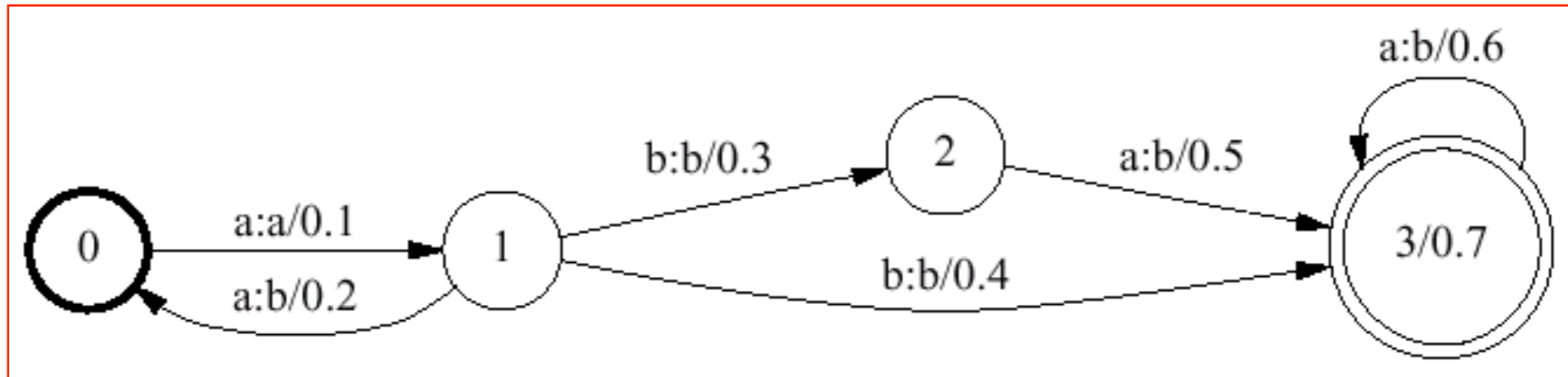

*

=

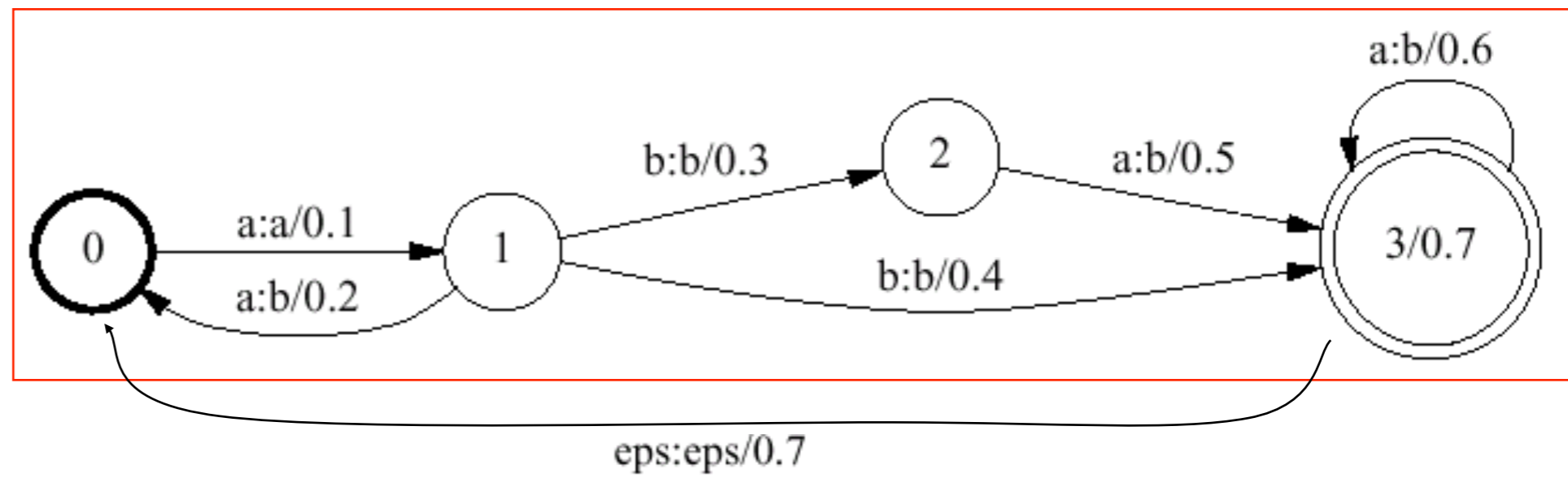

Closure (this example has outputs too)

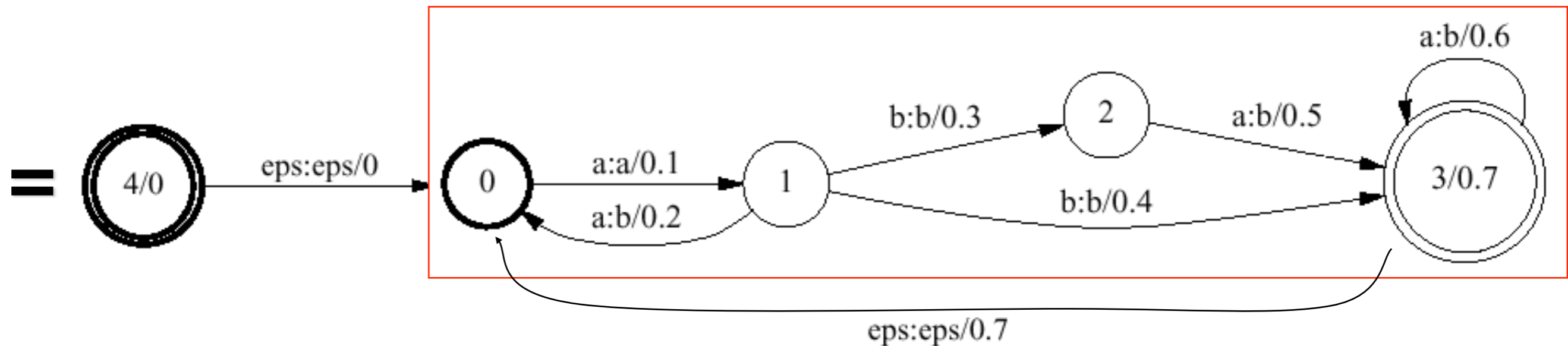
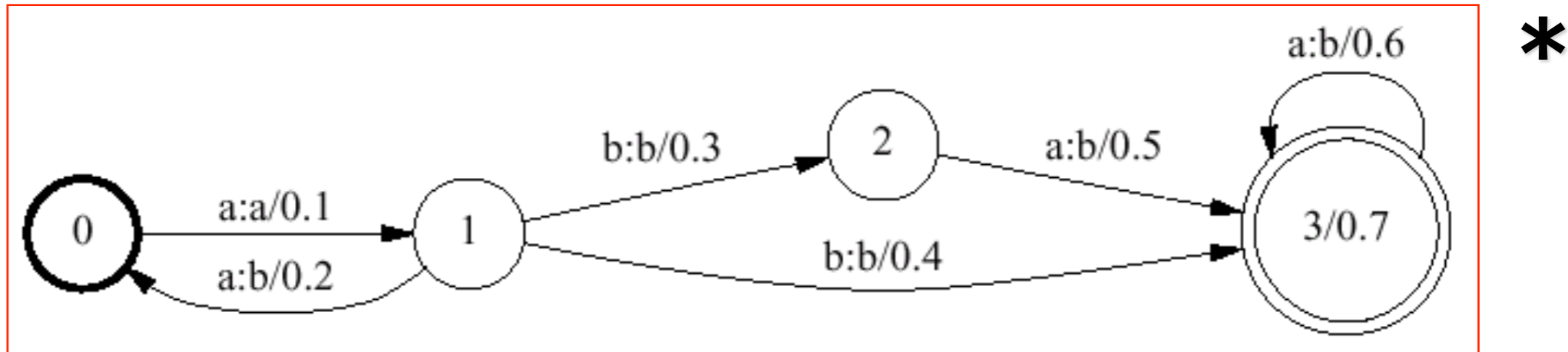

Closure (this example has outputs too)

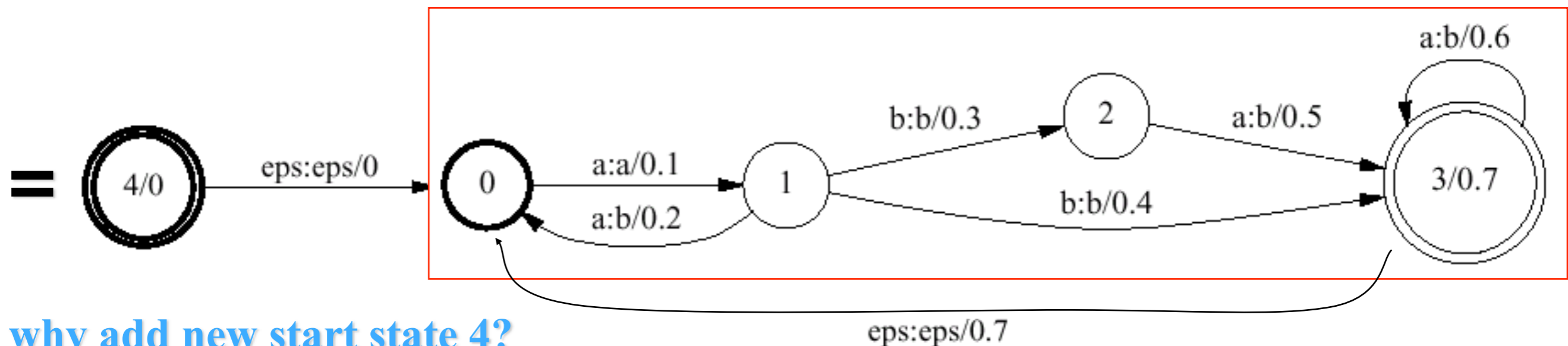
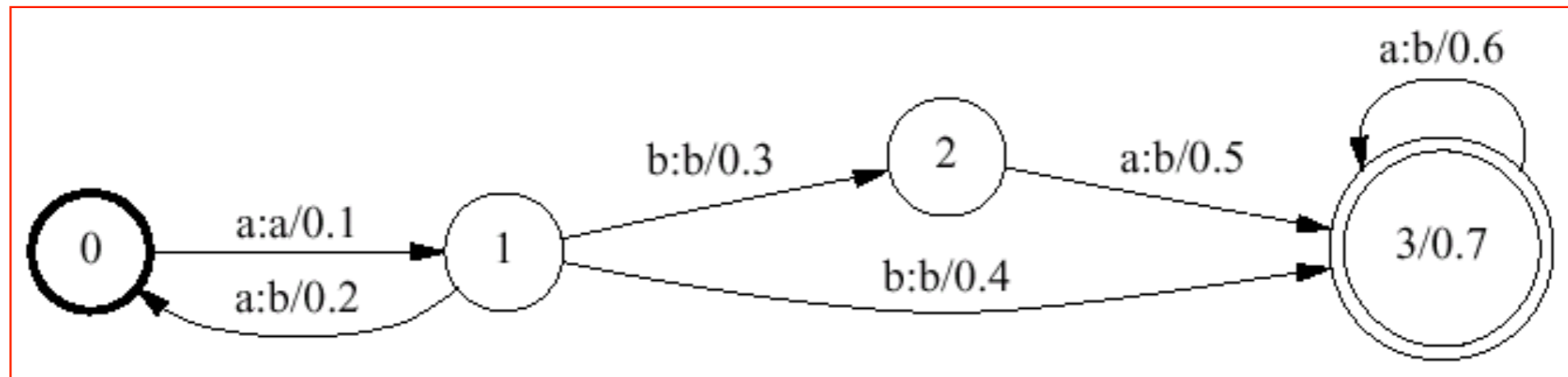

why add new start state 4?
 why not just make state 0 final?

Upper language (domain)

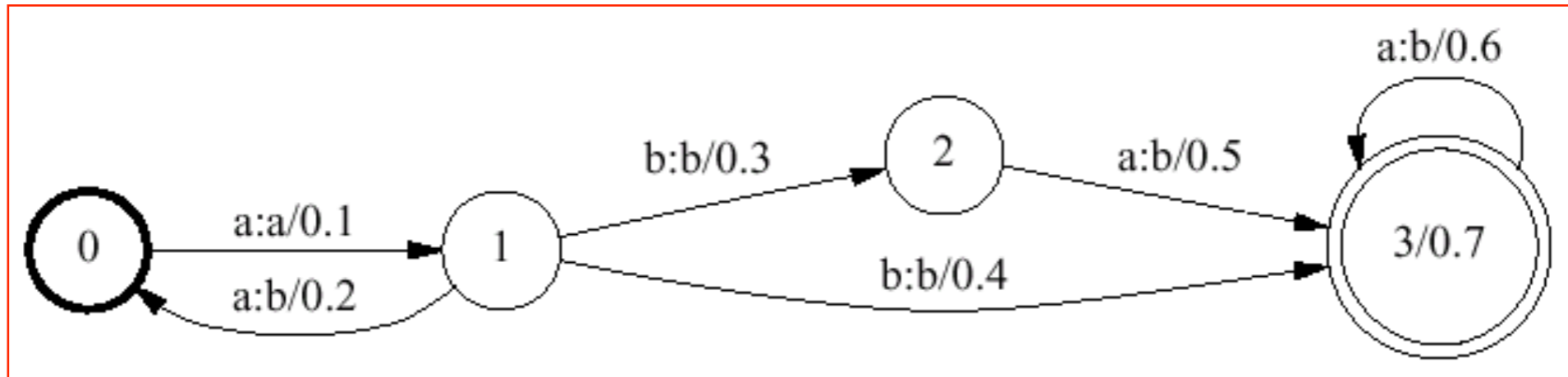

.u

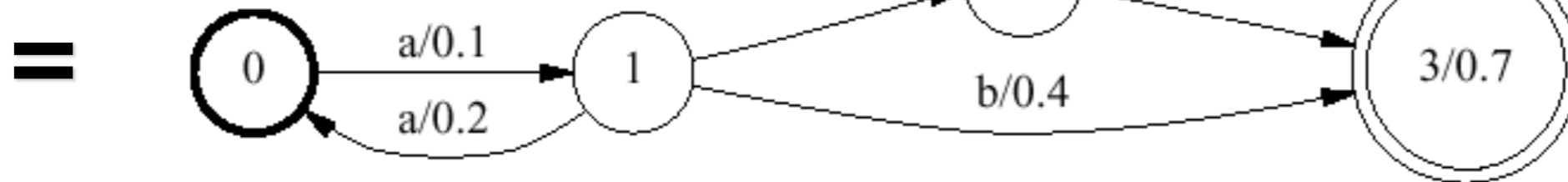

Upper language (domain)

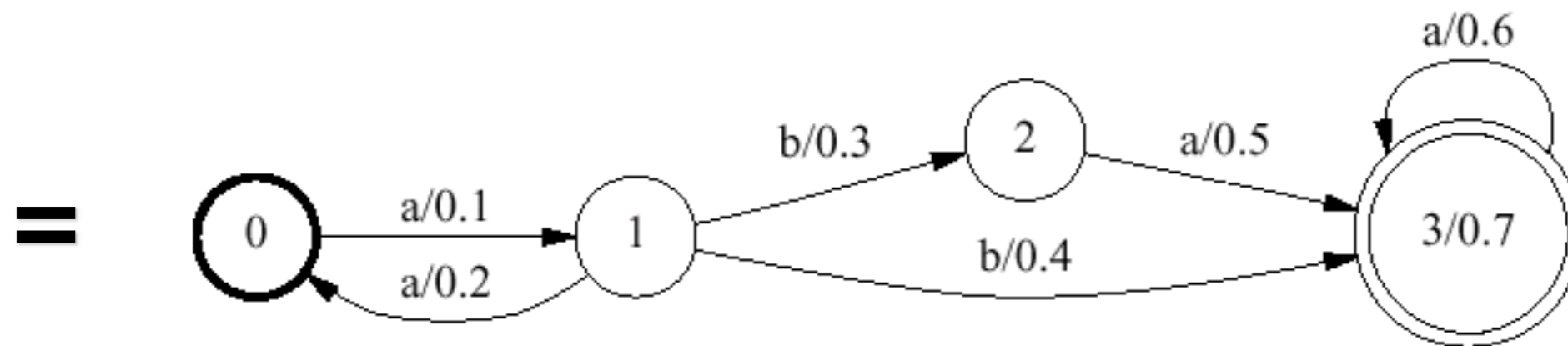
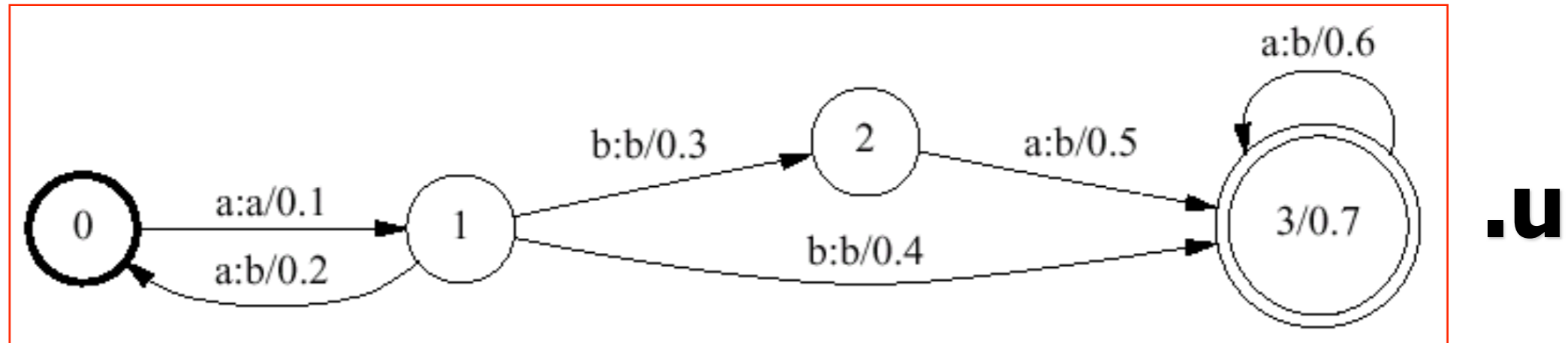

similarly construct lower language .l

Upper language (domain)

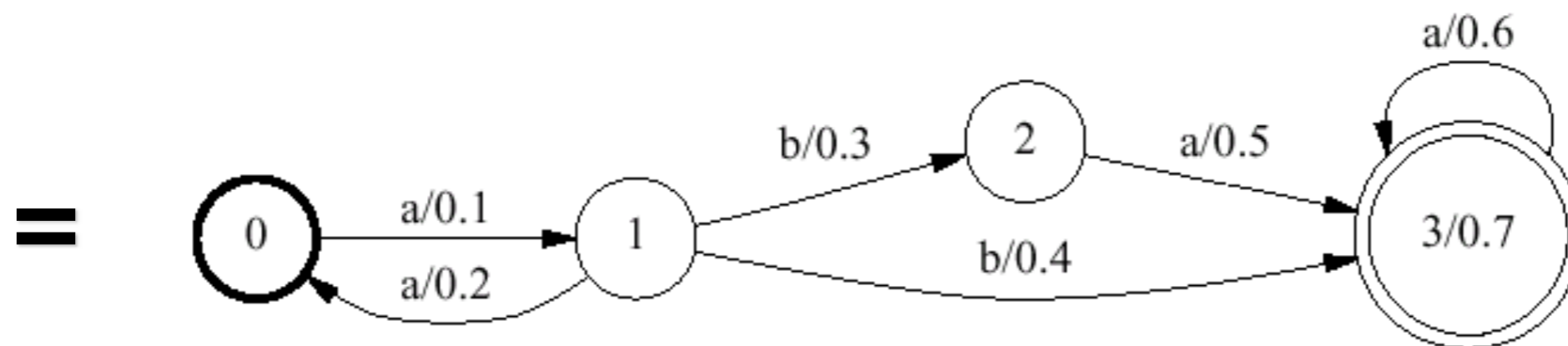
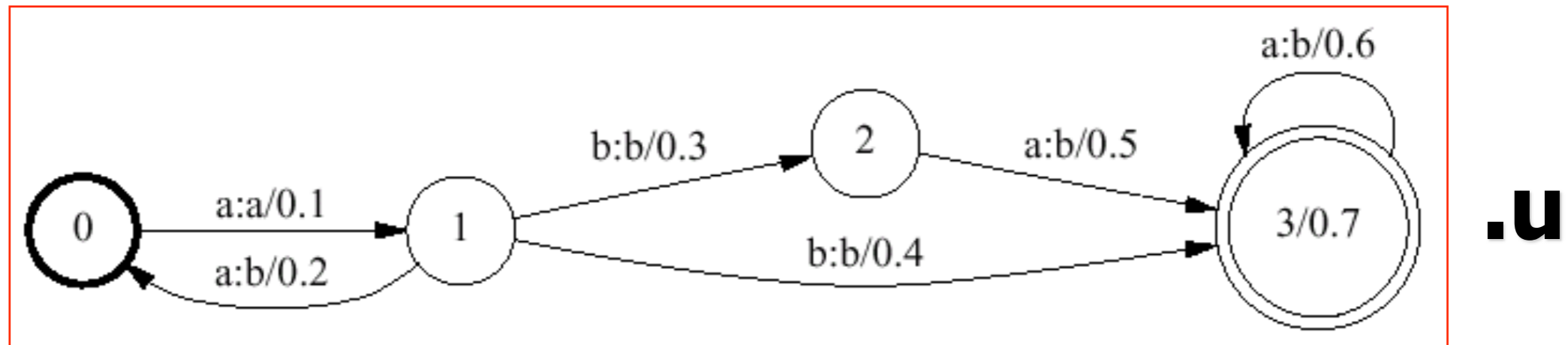

similarly construct lower language .l
also called input & output languages

Reversal

Reversal

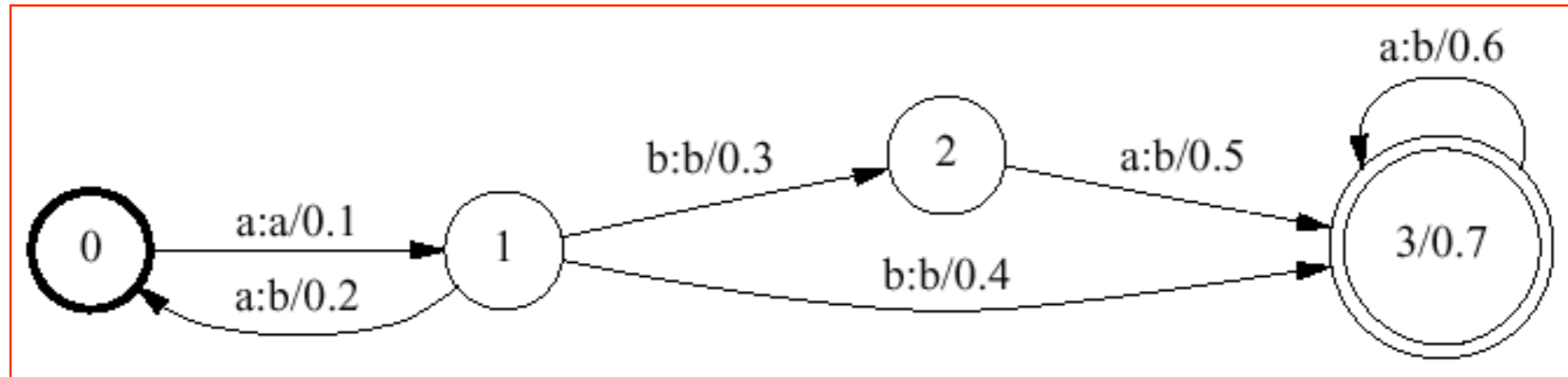

.r

Reversal

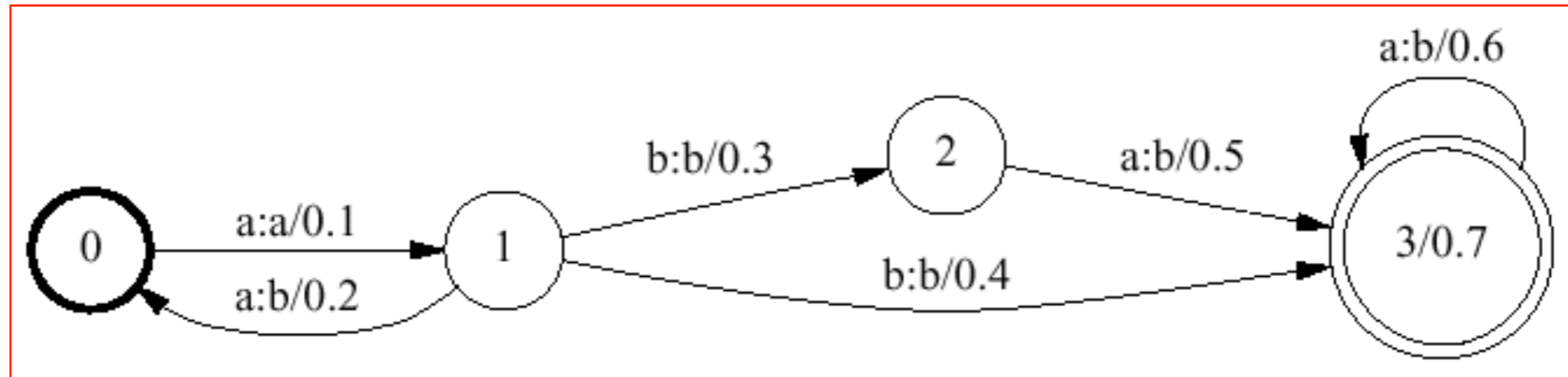

r

=

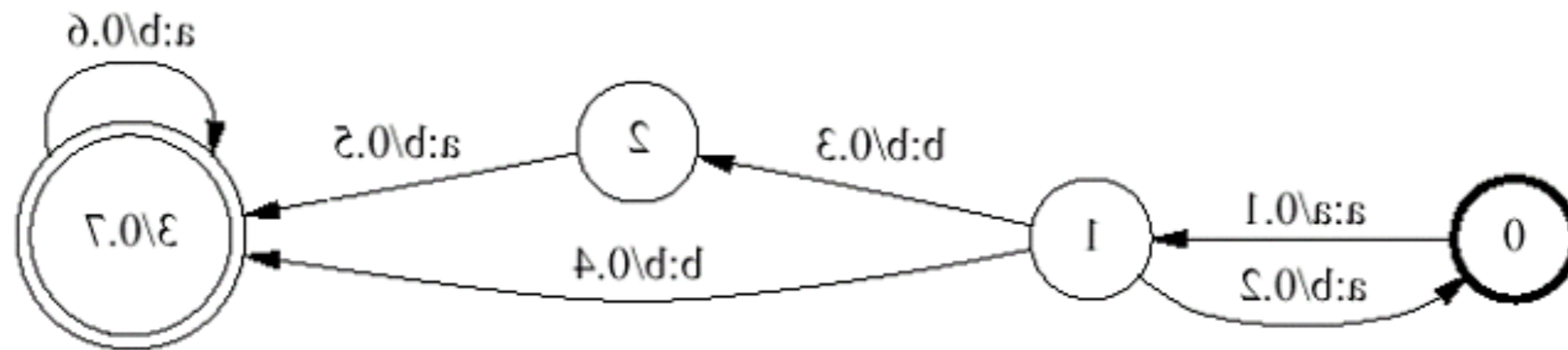

Reversal

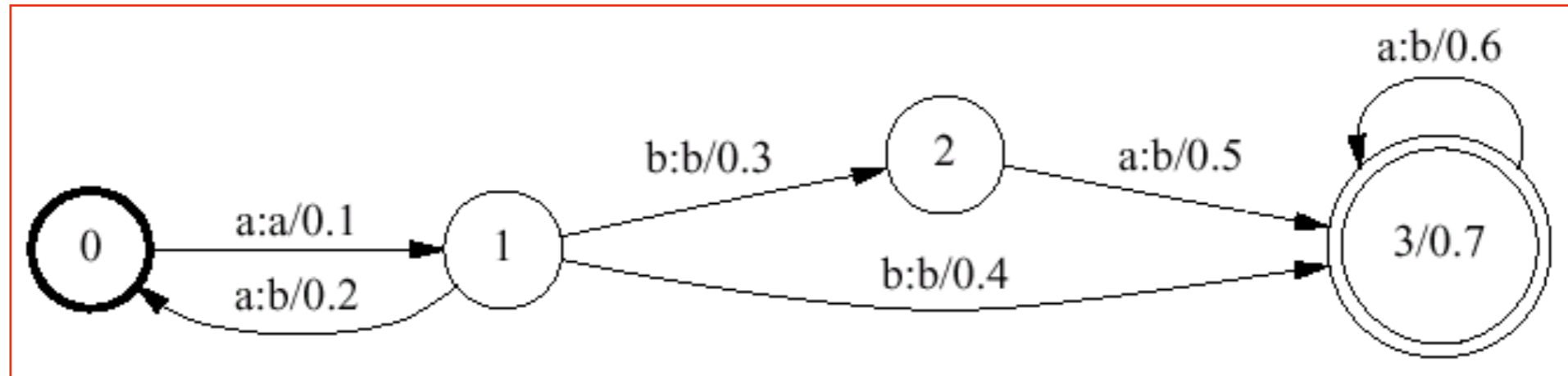

.r

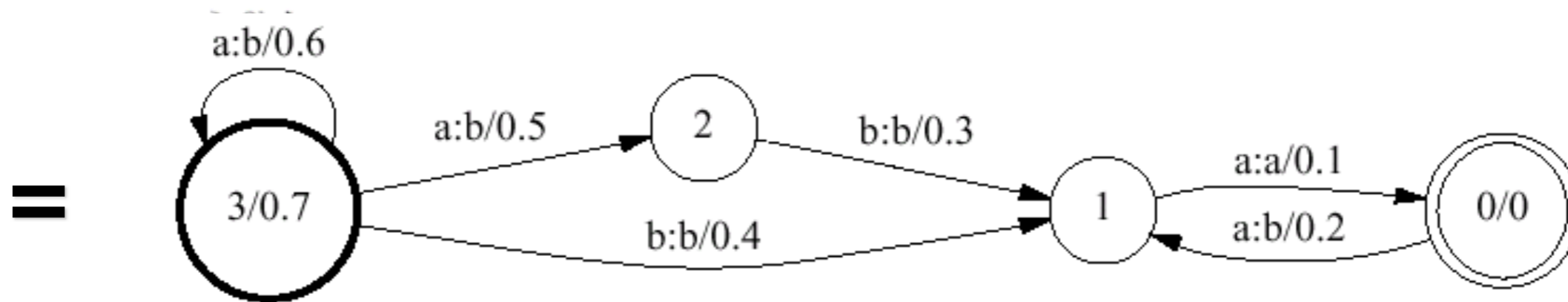

Inversion

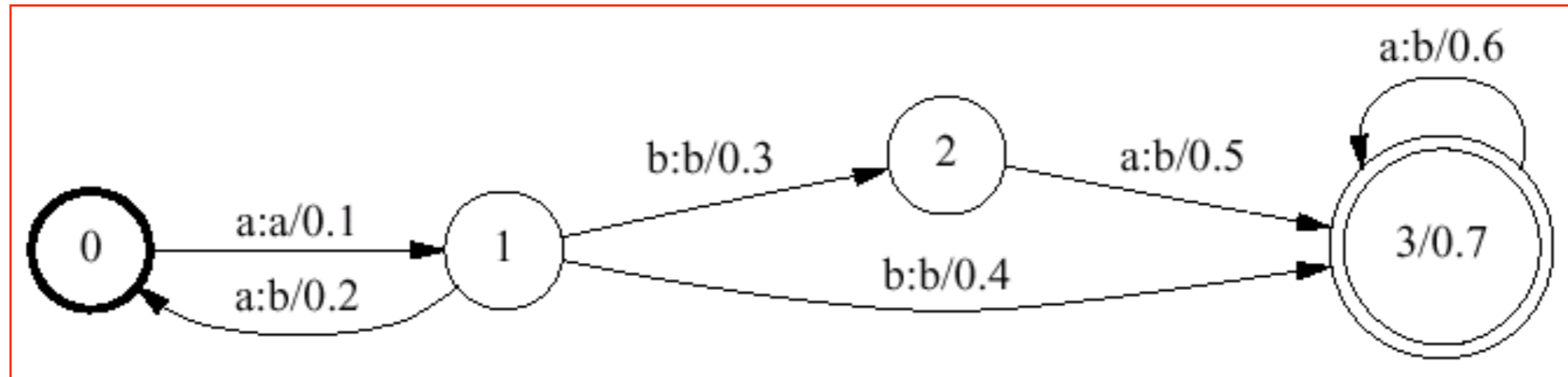

.i

Inversion

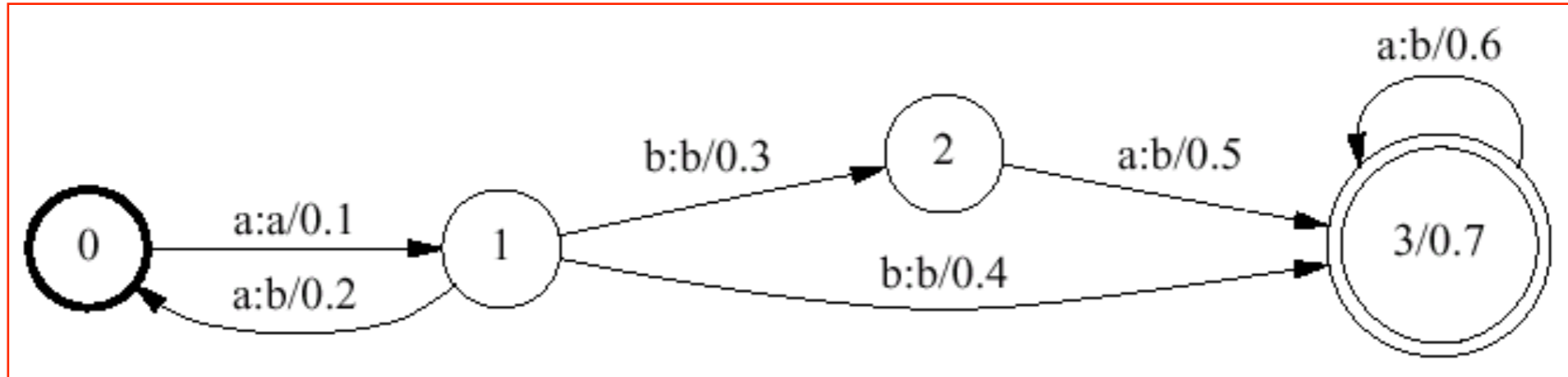

i

=

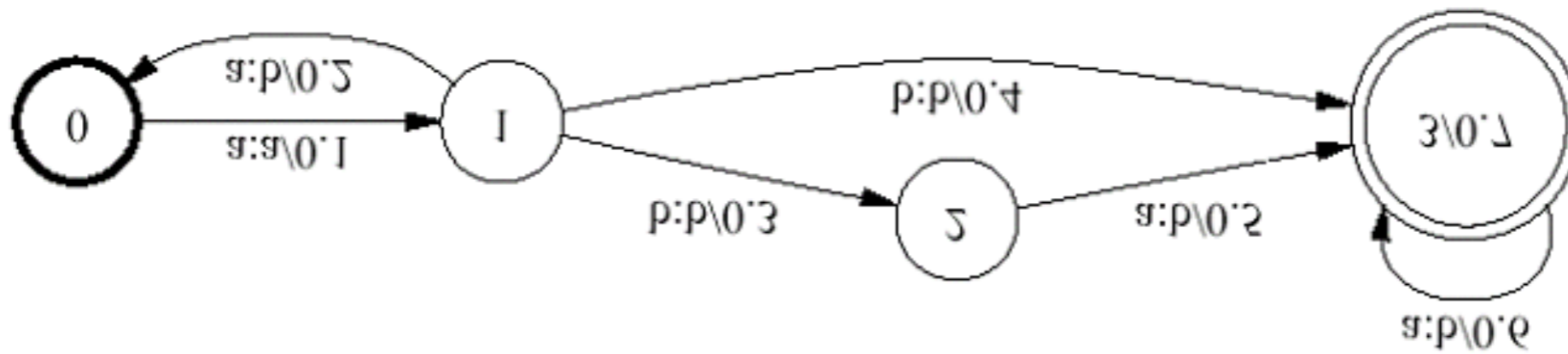

Inversion

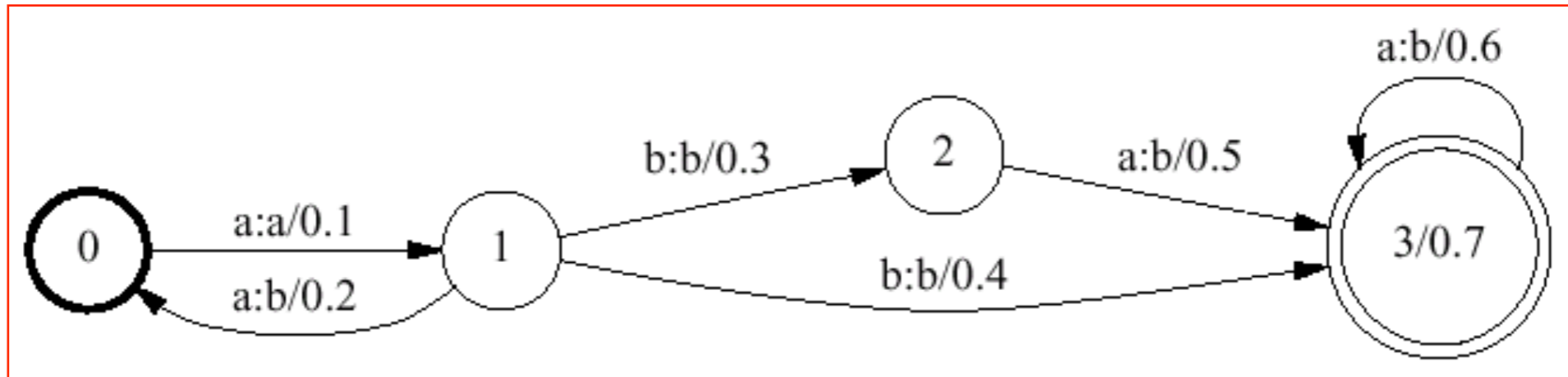

i

=

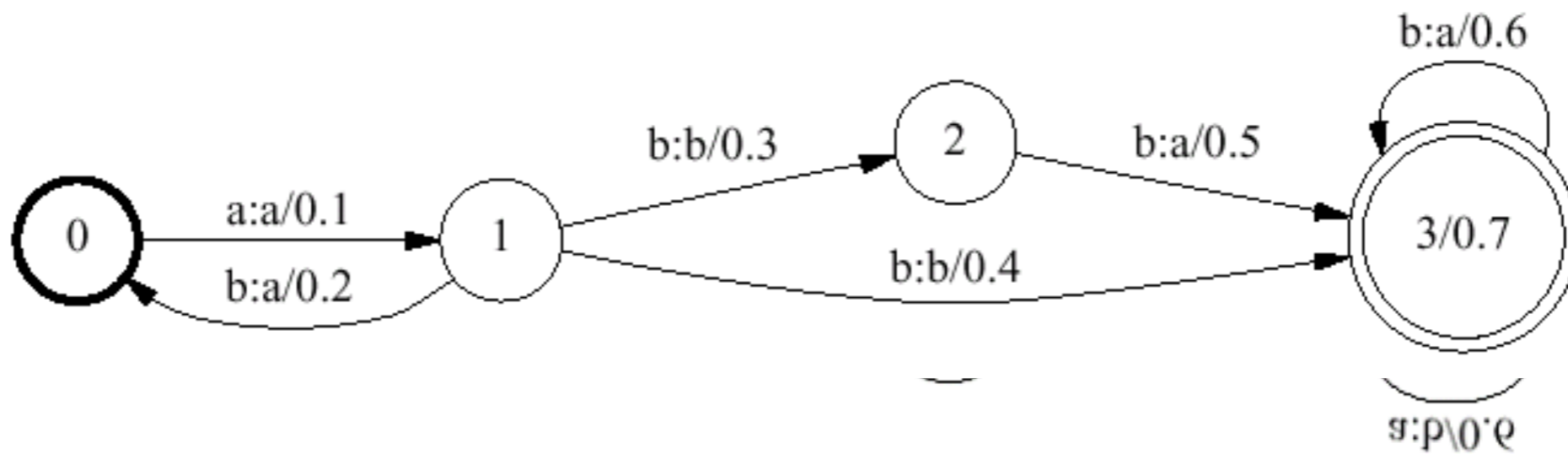

Inversion

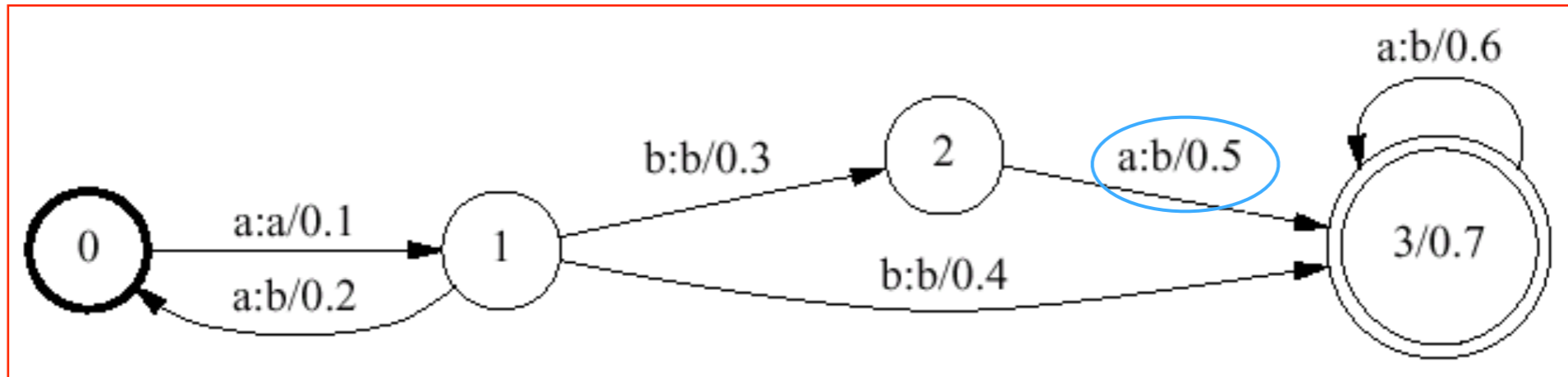

i

=

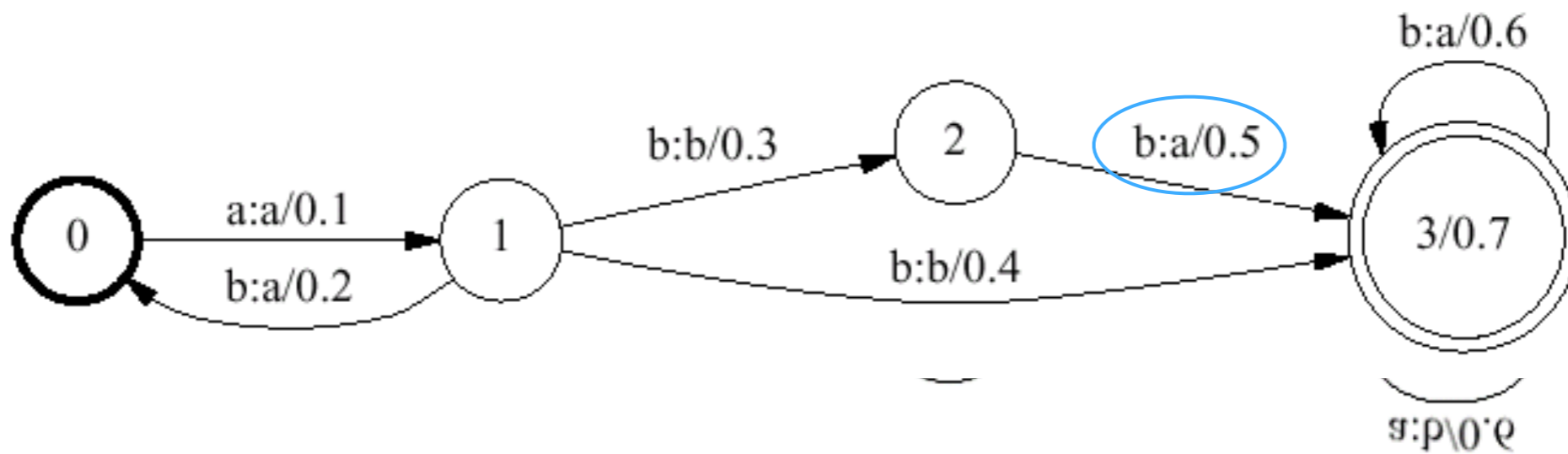

$s:p \setminus 0 \cdot q$

Complementation

- Given a machine M , represent all strings not accepted by M
- Just change final states to non-final and vice-versa
- Works only if machine has been determinized and completed first

Intersection

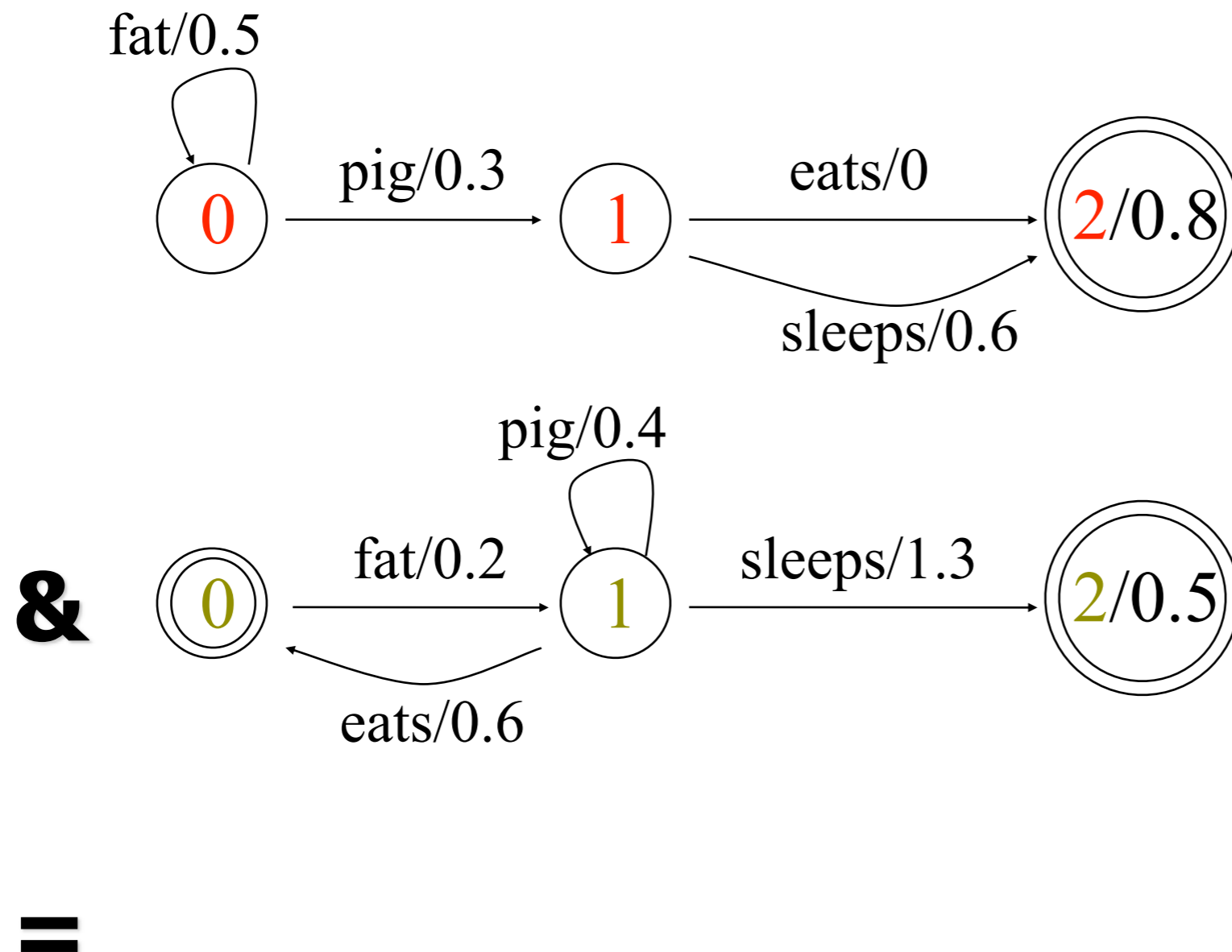

Intersection

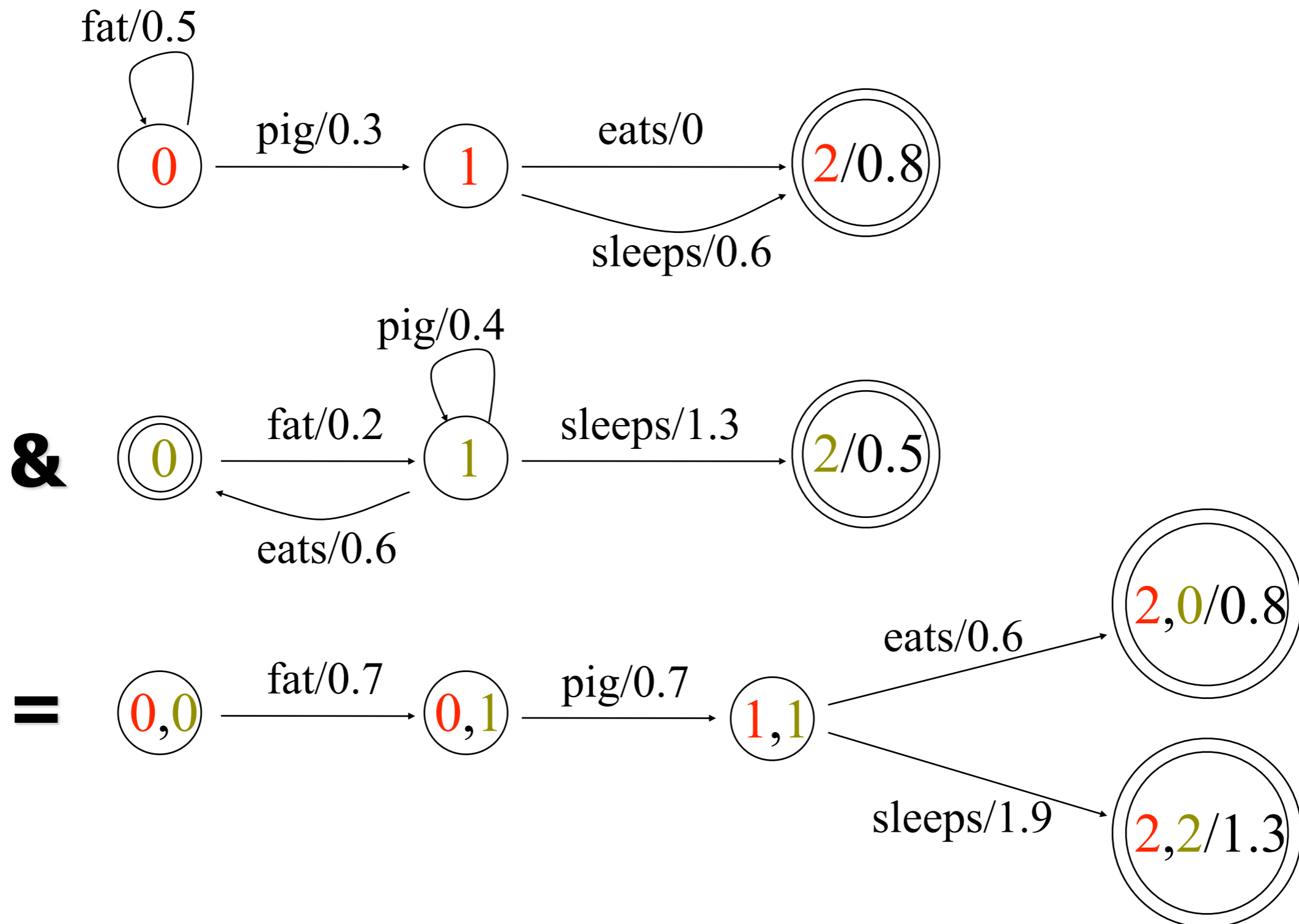

Intersection

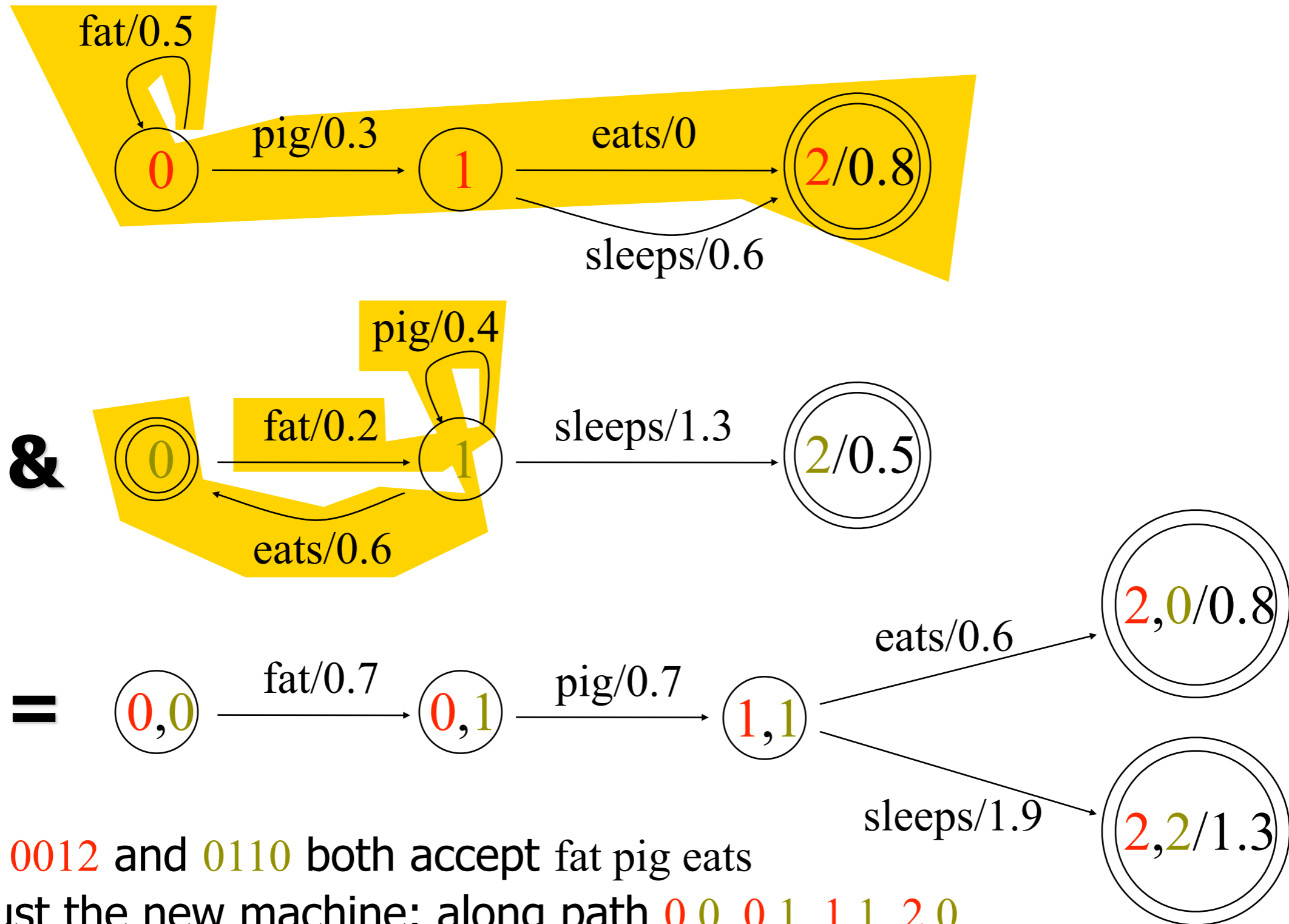

Paths **0012** and **0110** both accept fat pig eats

So must the new machine: along path **0,0 0,1 1,1 2,0**

Intersection

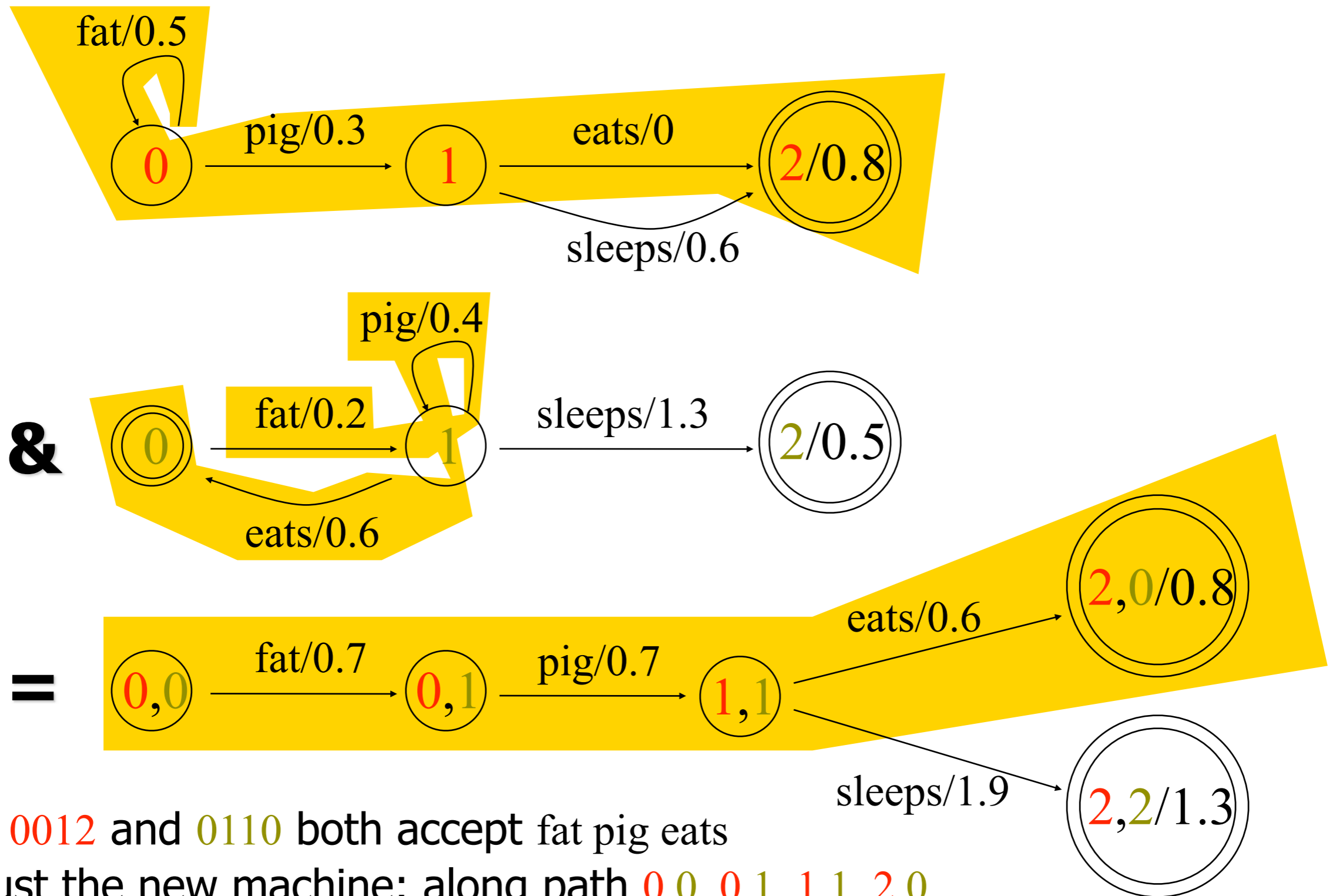

Paths **0012** and **0110** both accept fat pig eats

So must the new machine: along path **0,0 0,1 1,1 2,0**

Intersection

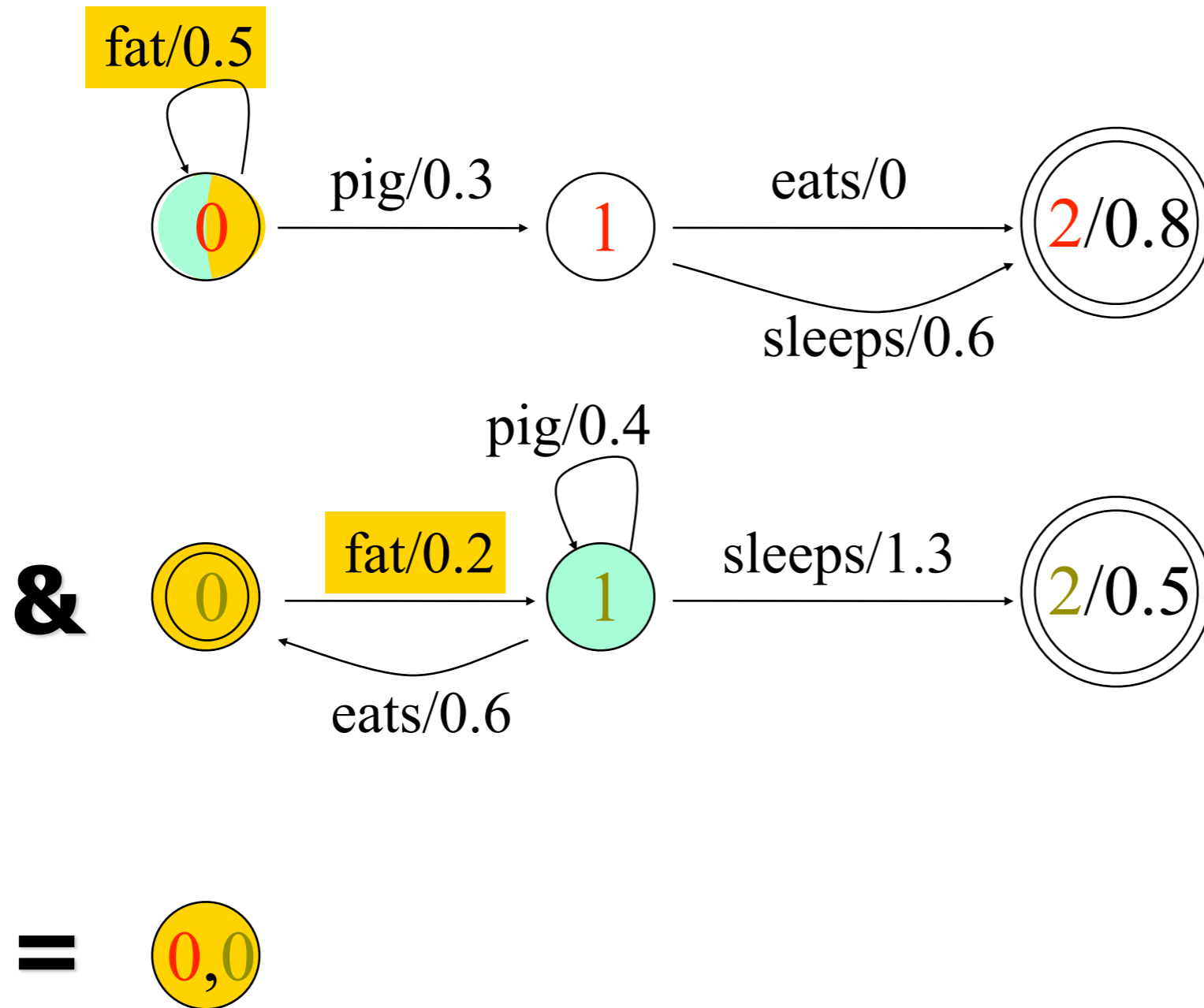

Paths **00** and **01** both accept fat

So must the new machine: along path **0,0** **0,1**

Intersection

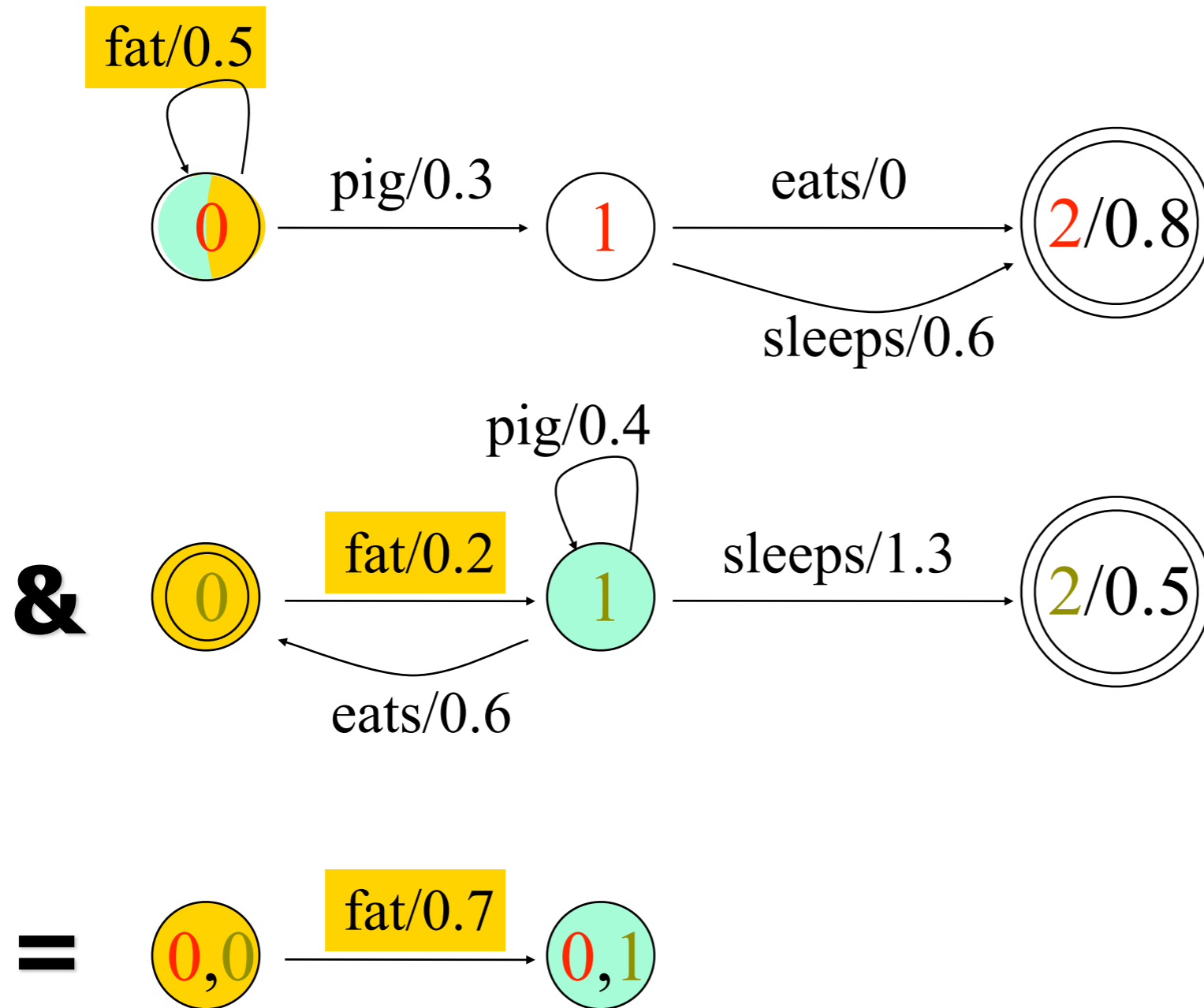

Paths **00** and **01** both accept fat

So must the new machine: along path **0,0** **0,1**

Intersection

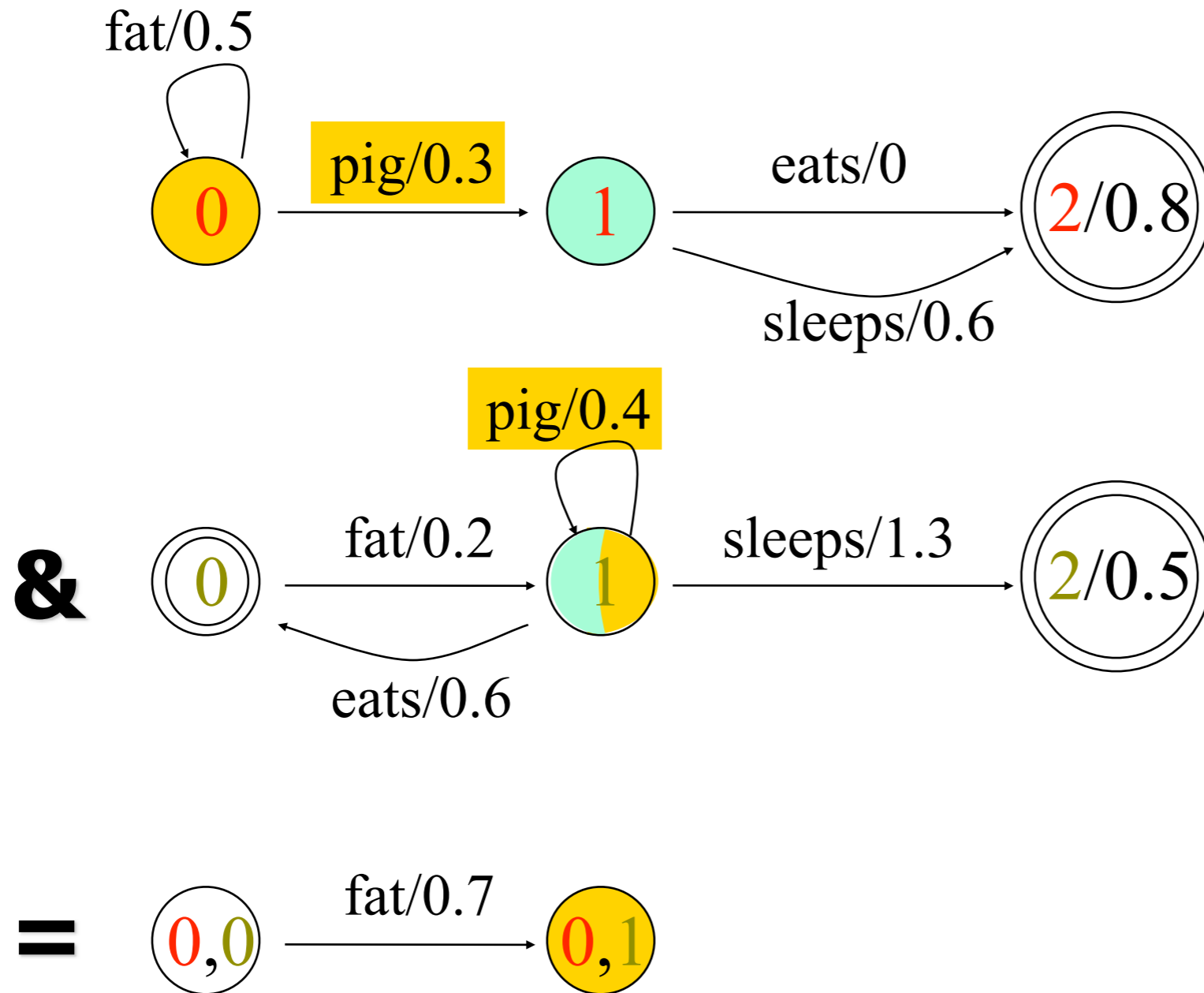

Paths **00** and **11** both accept pig

So must the new machine: along path **0,1 1,1**

Intersection

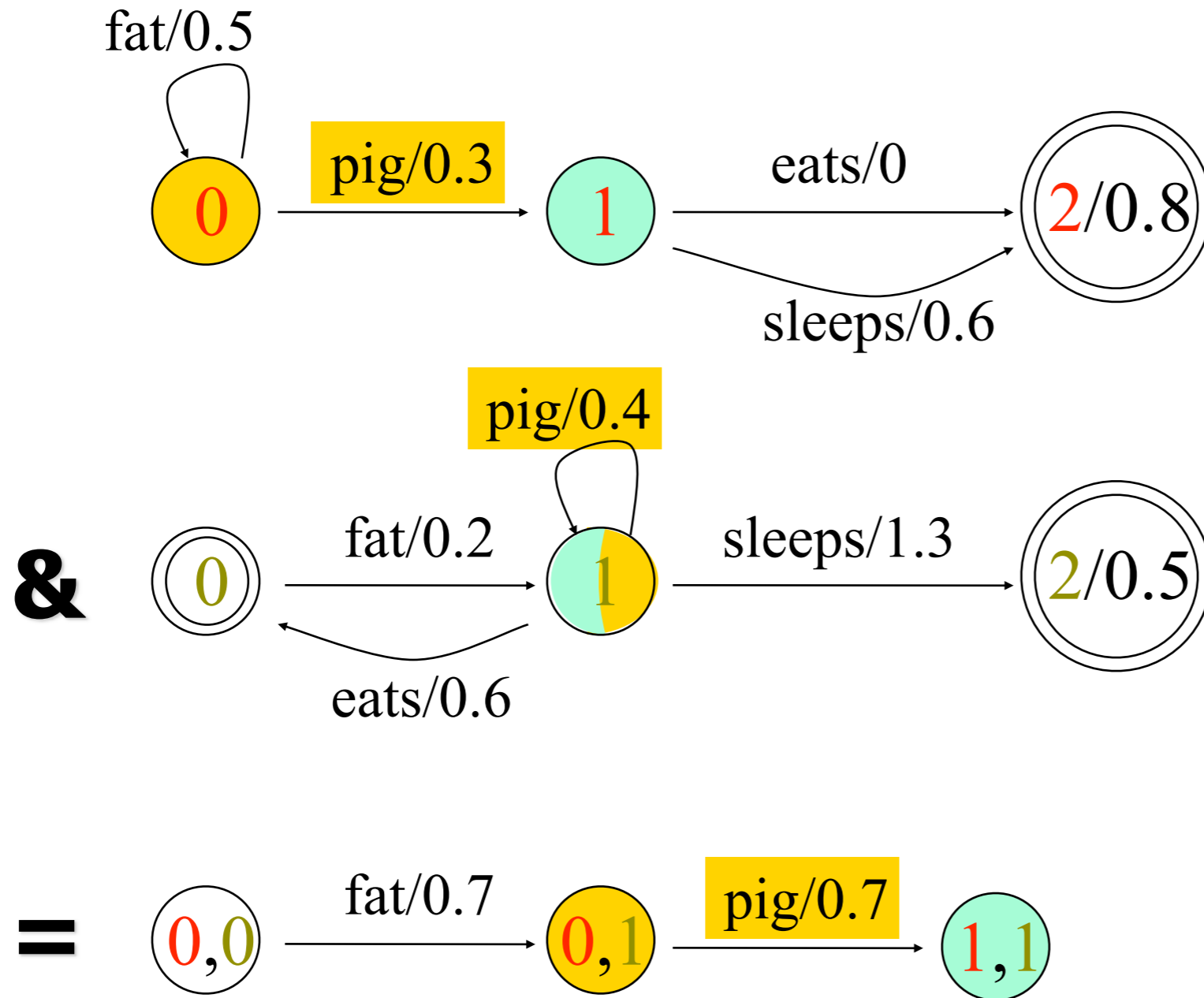

Paths **00** and **11** both accept pig

So must the new machine: along path **0,1 1,1**

Intersection

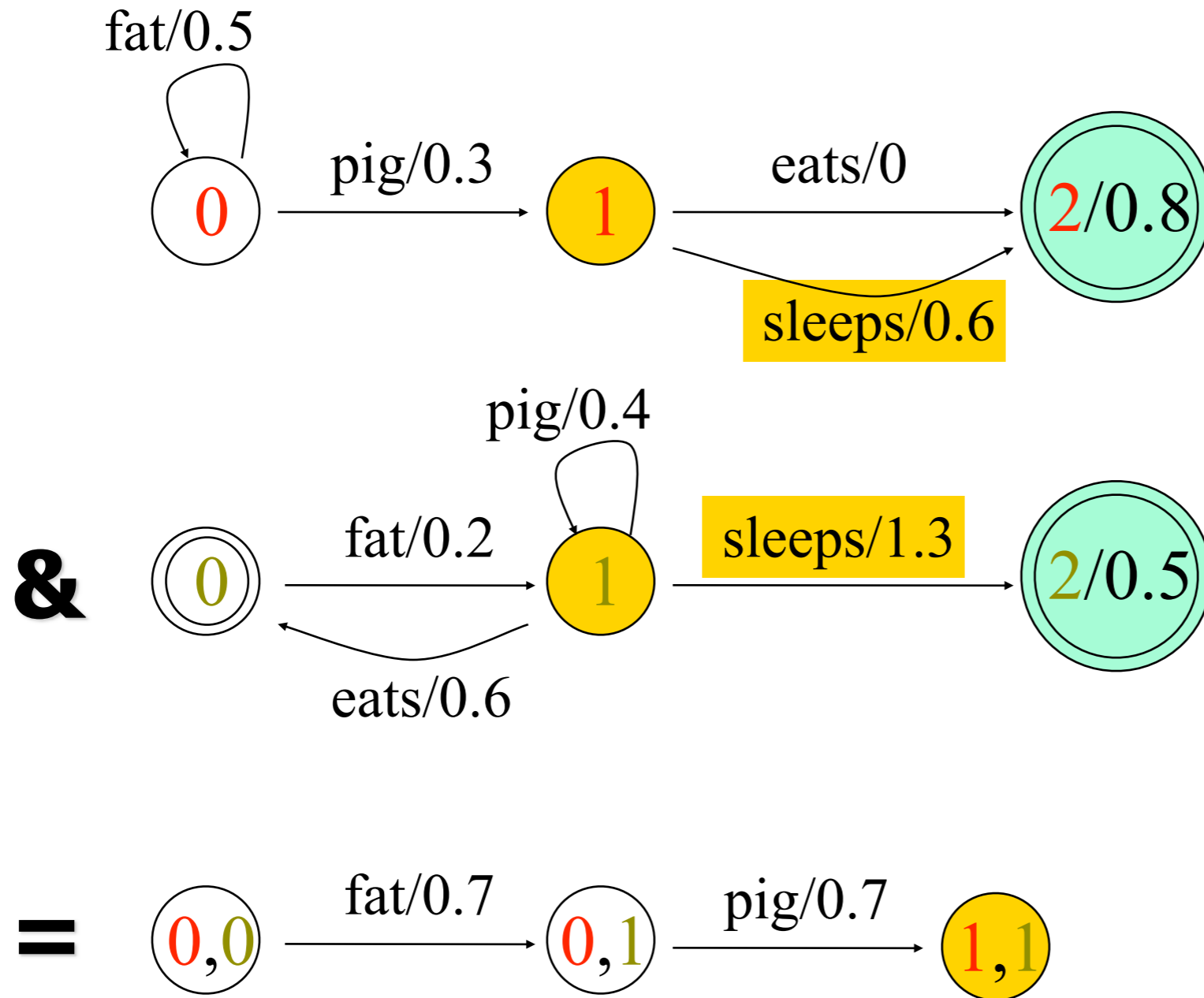

Paths 12 and 12 both accept fat

So must the new machine: along path 1,1 2,2

Intersection

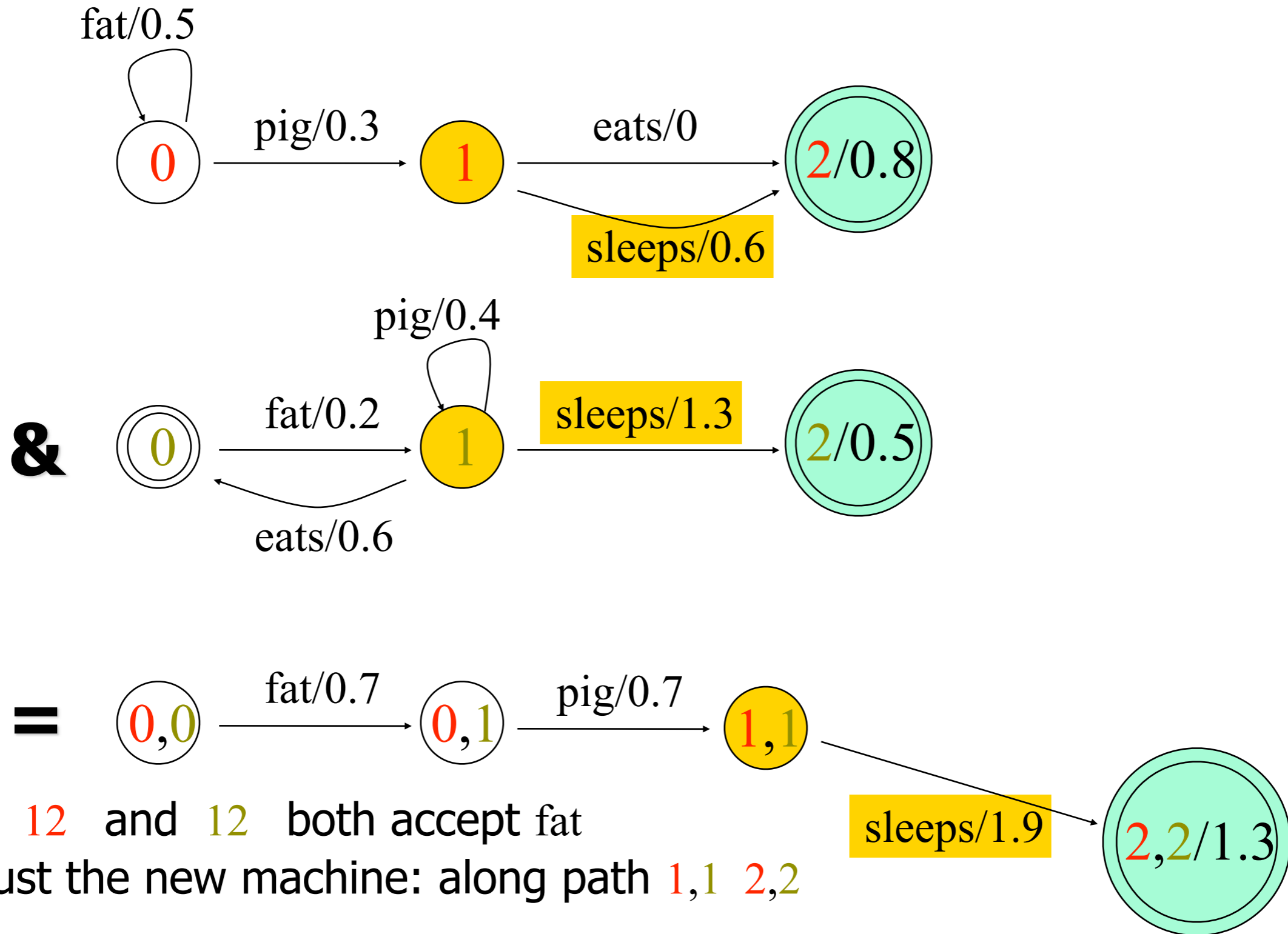

Intersection

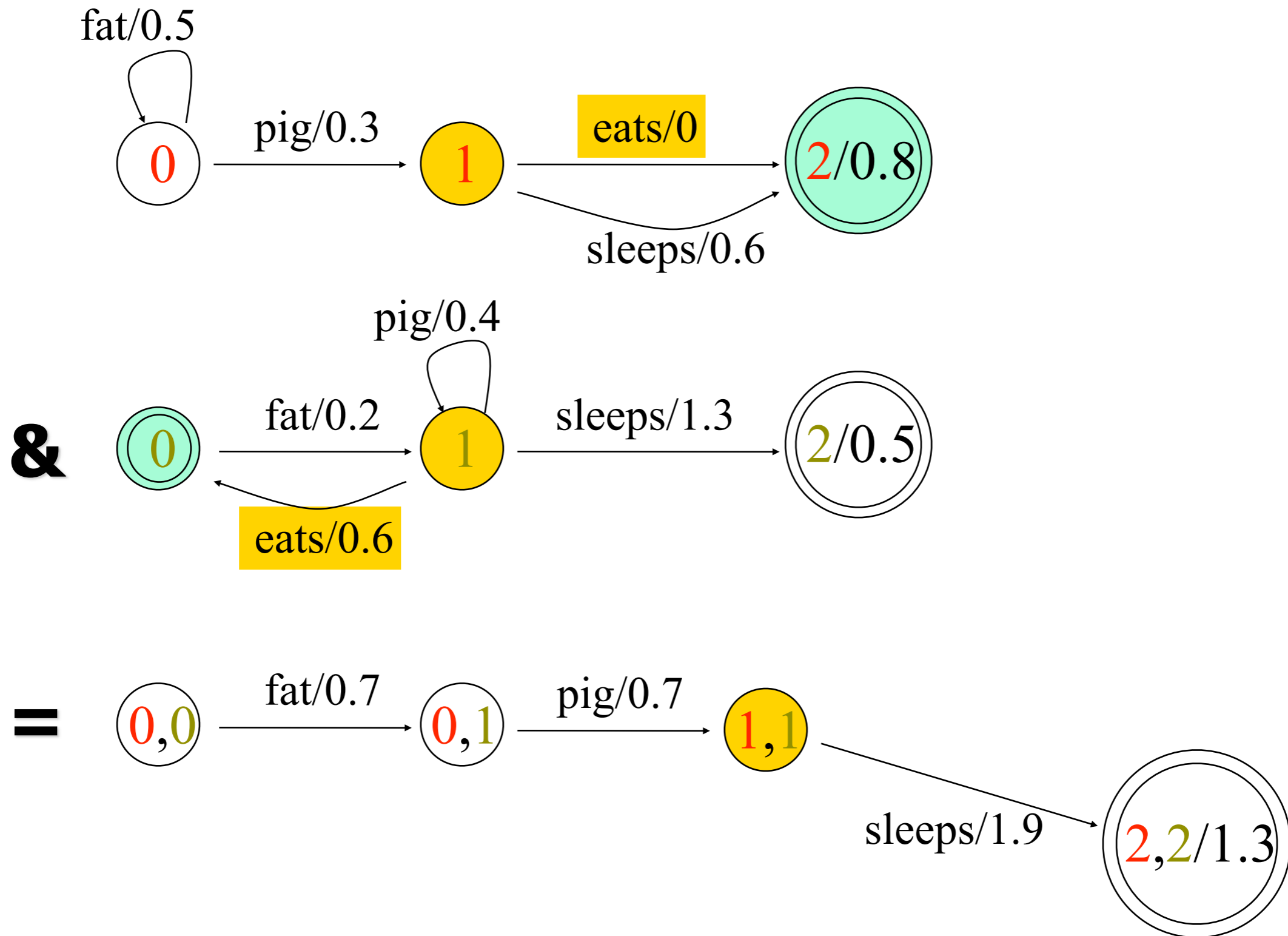

Intersection

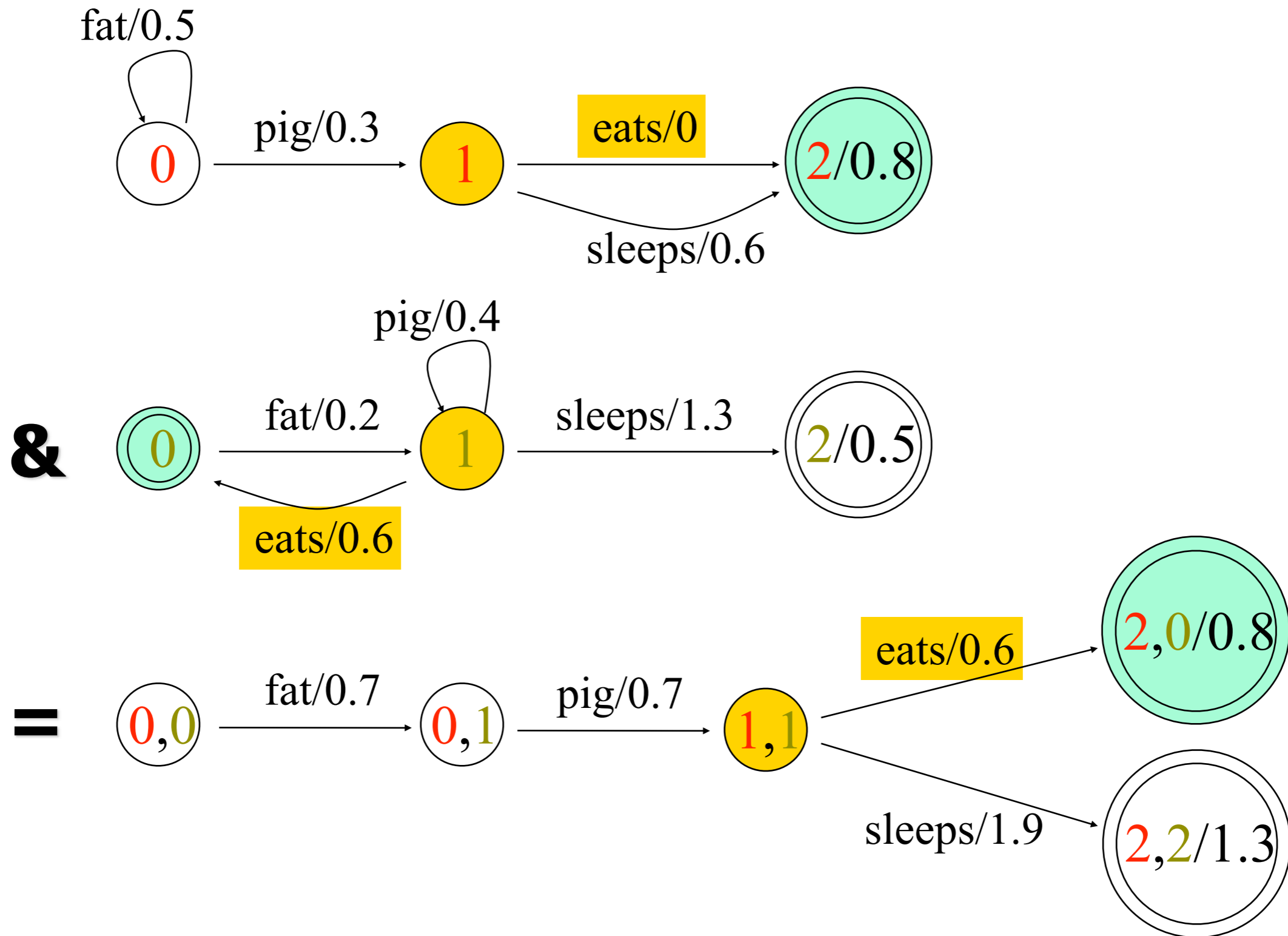

What Composition Means

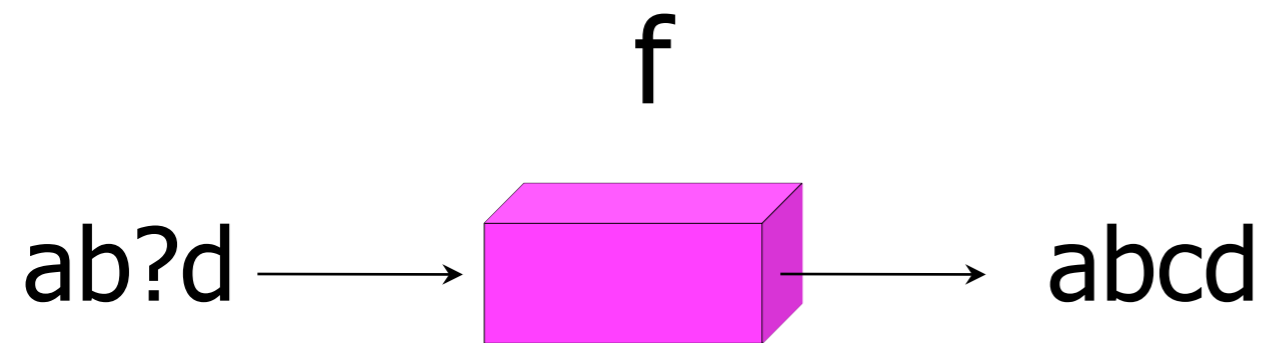

What Composition Means

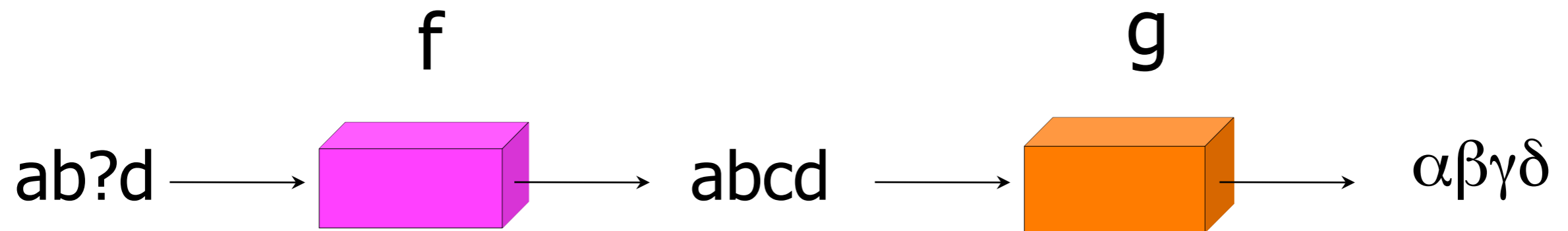

What Composition Means

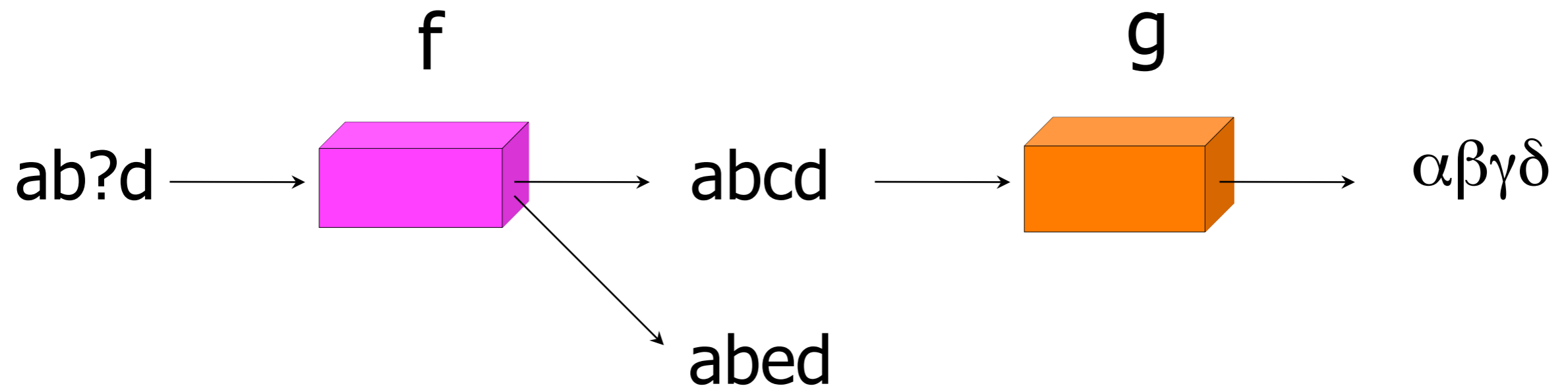

What Composition Means

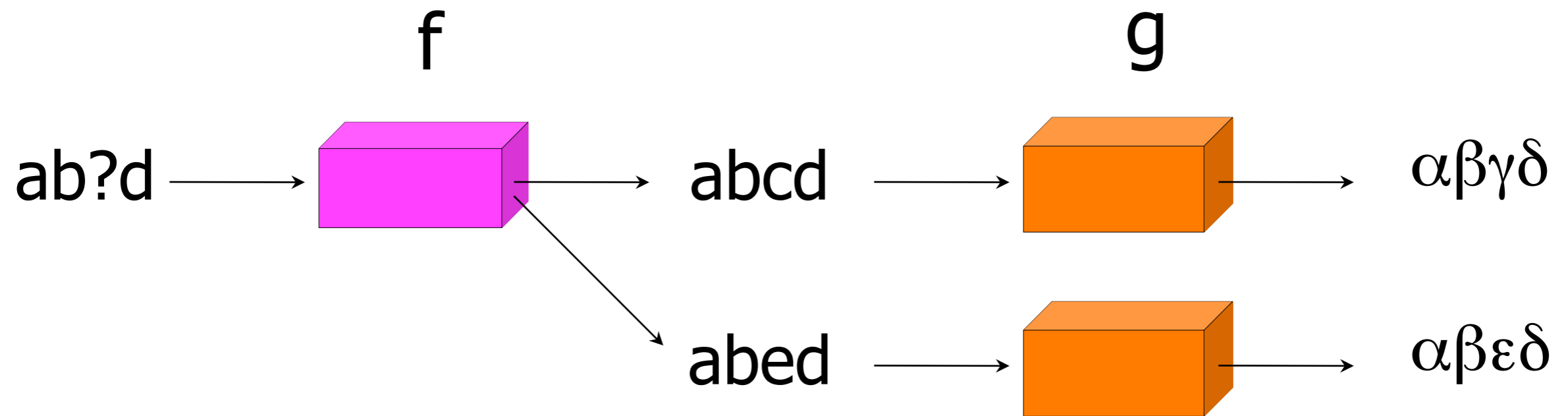

What Composition Means

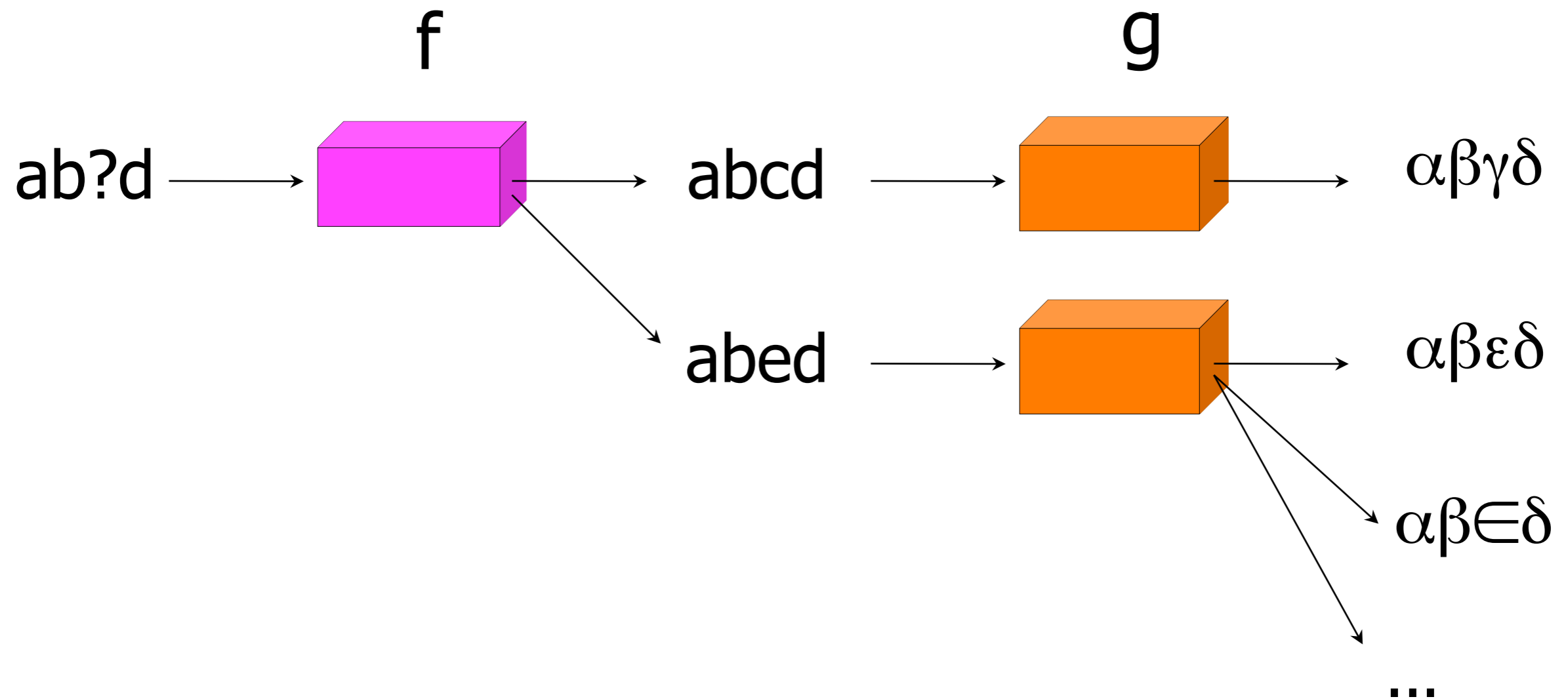

What Composition Means

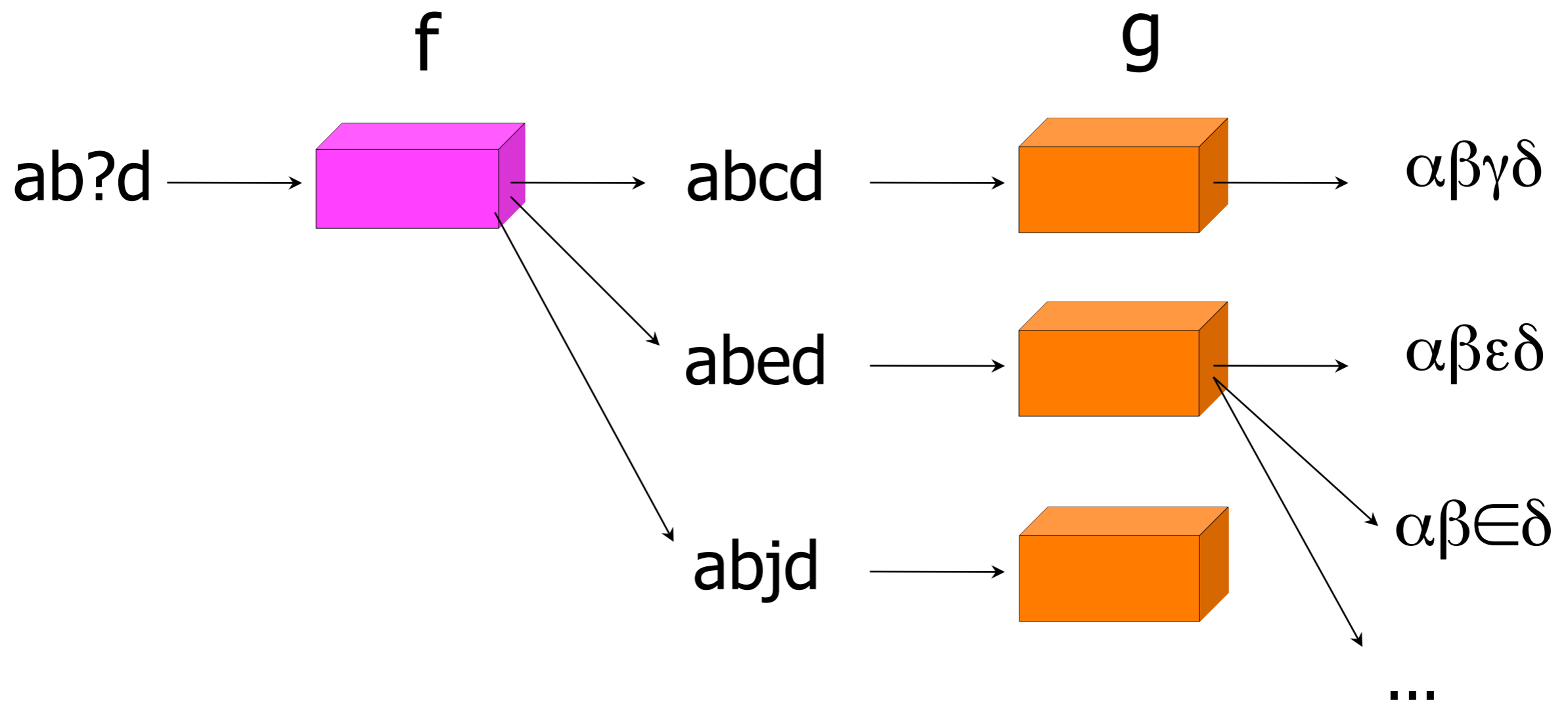

What Composition Means

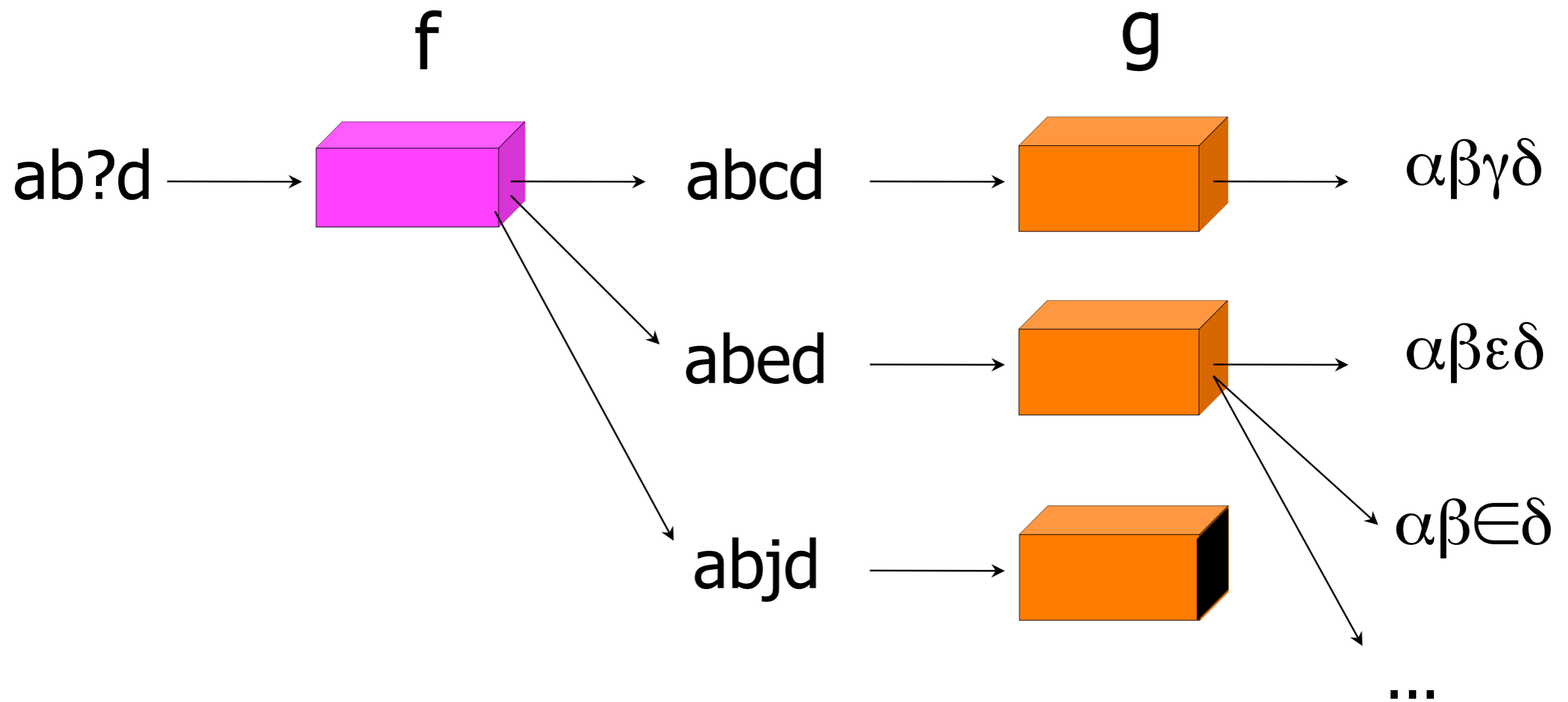

What Composition Means

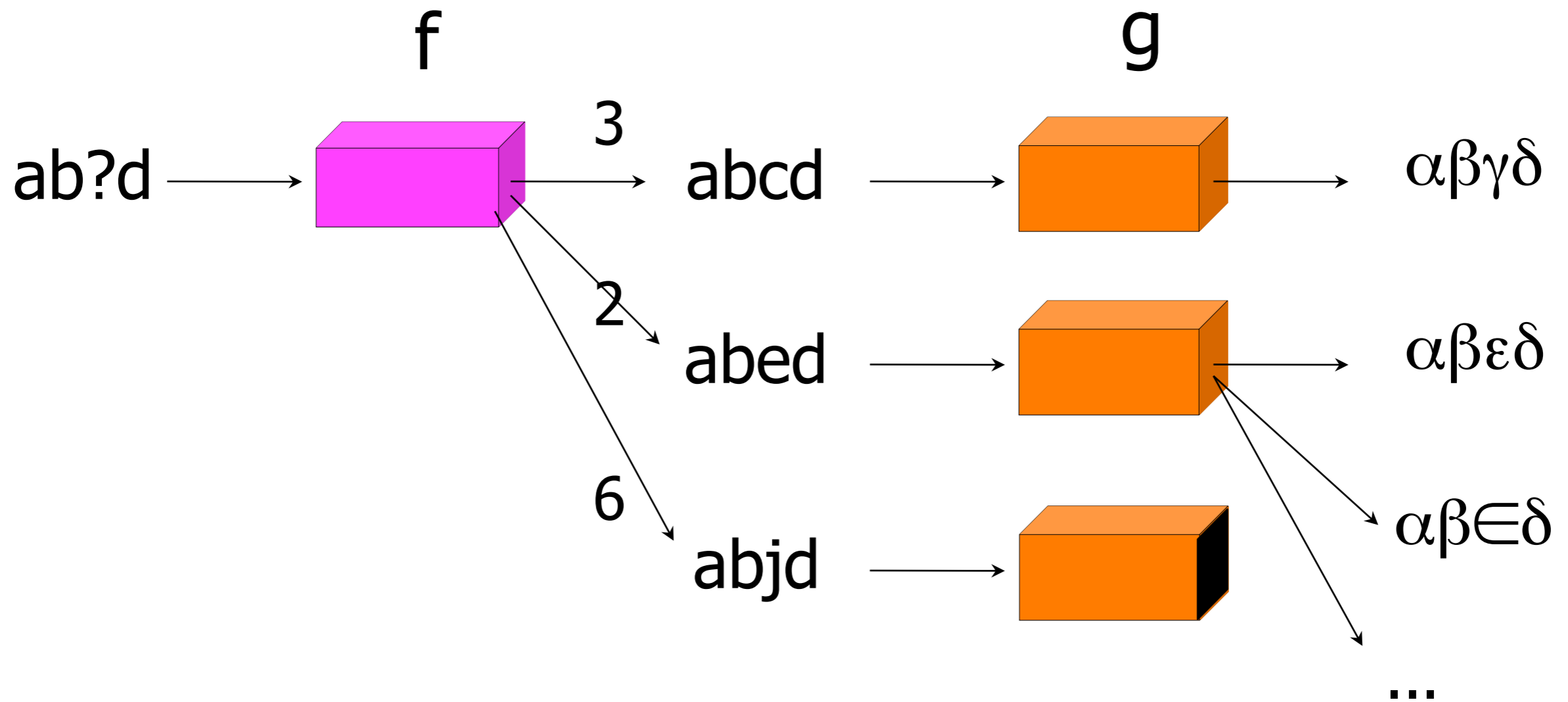

What Composition Means

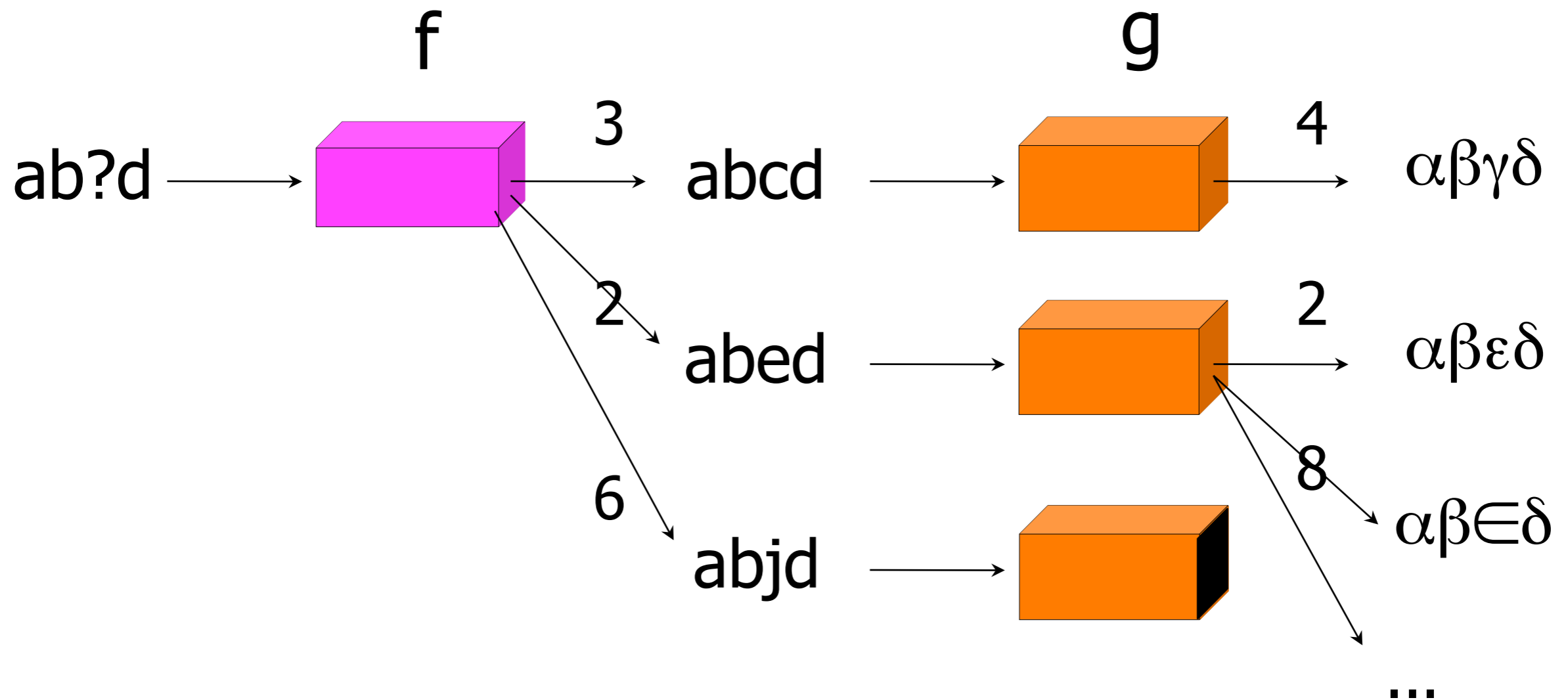

What Composition Means

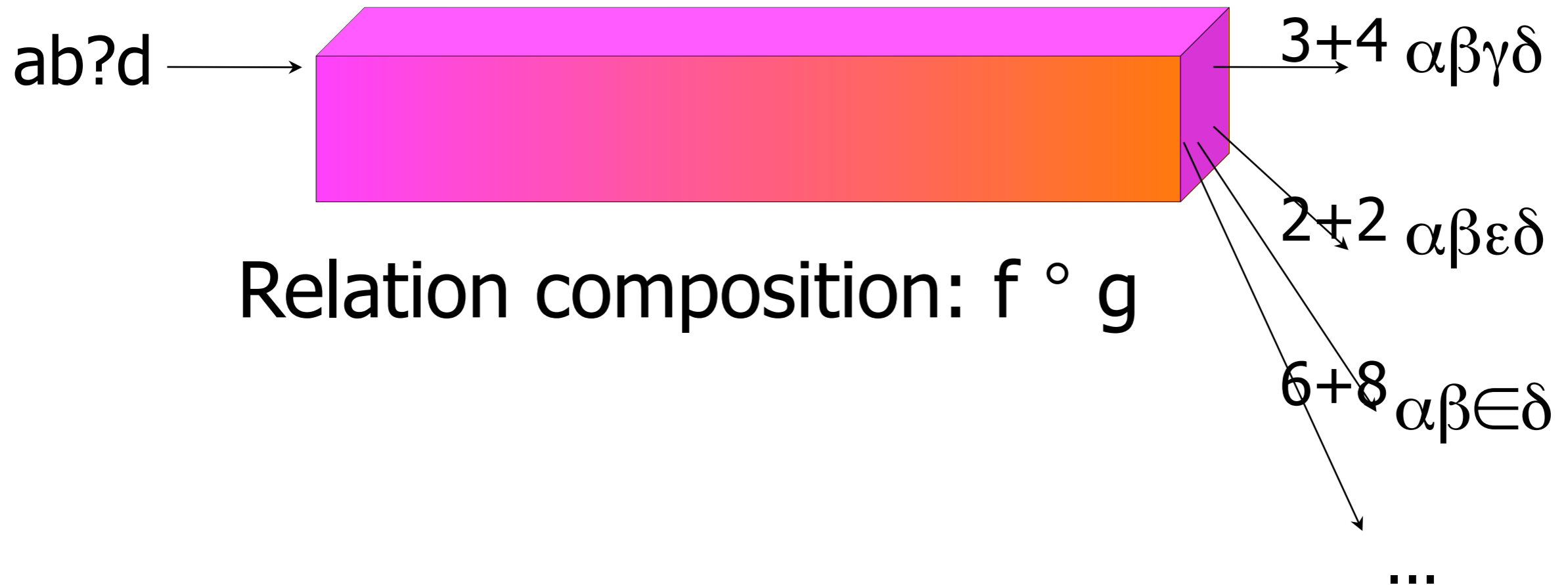

Relation = set of pairs

$$\left\{ \begin{array}{l} ab?d \rightarrow abcd \\ ab?d \rightarrow abed \\ ab?d \rightarrow abjd \\ \dots \end{array} \right\}$$
$$\left\{ \begin{array}{l} abcd \rightarrow \alpha\beta\gamma\delta \\ abed \rightarrow \alpha\beta\varepsilon\delta \\ abed \rightarrow \alpha\beta\epsilon\delta \\ \dots \end{array} \right\}$$

f

g

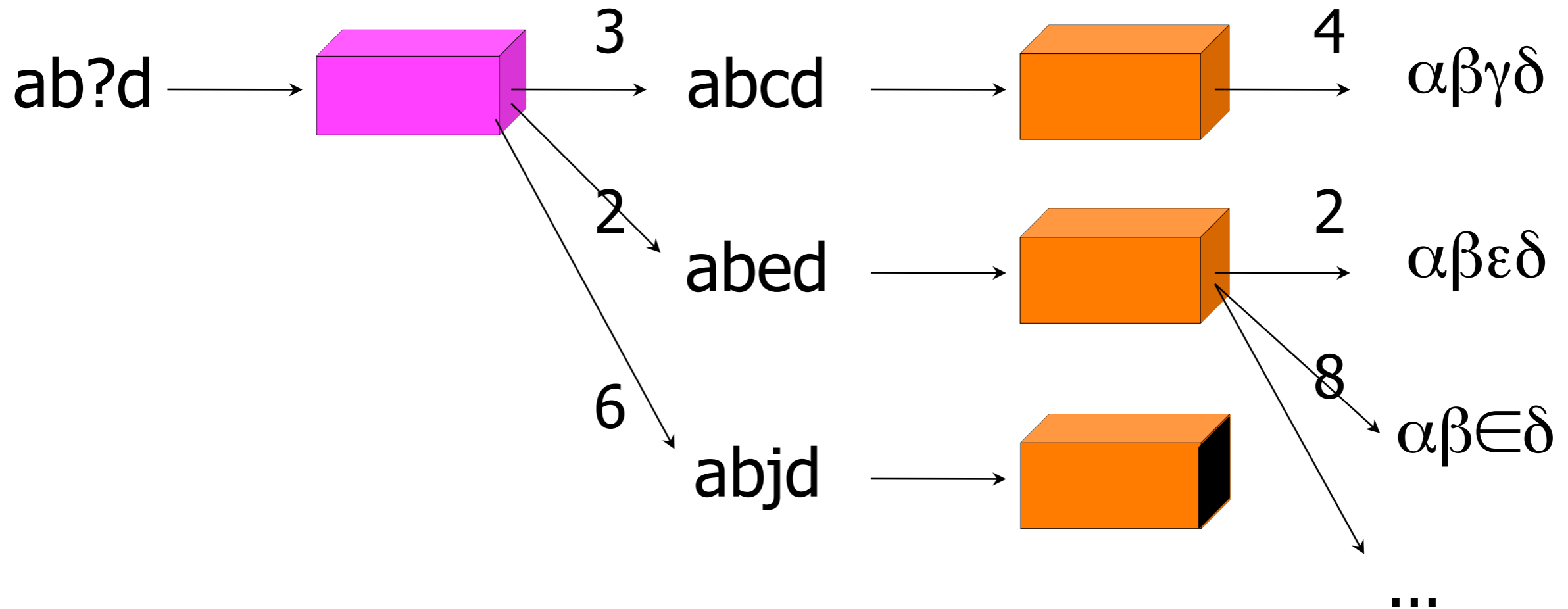

Relation = set of pairs

does not contain any pair of the form $abjd \rightarrow \dots$

$$\left\{ \begin{array}{l} ab?d \rightarrow abcd \\ ab?d \rightarrow abed \\ ab?d \rightarrow abjd \\ \dots \end{array} \right\}$$

$$\left\{ \begin{array}{l} abcd \rightarrow \alpha\beta\gamma\delta \\ abed \rightarrow \alpha\beta\varepsilon\delta \\ abed \rightarrow \alpha\beta\epsilon\delta \\ \dots \end{array} \right\}$$

f

g

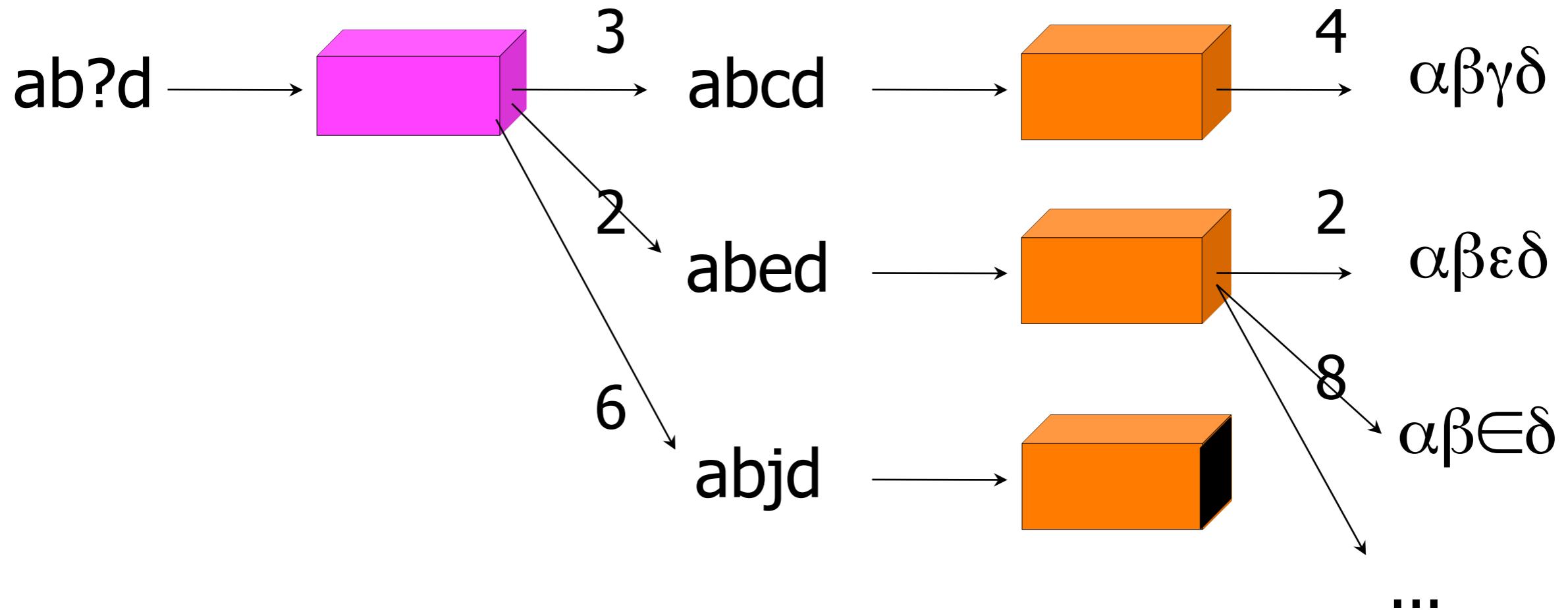

Relation = set of pairs

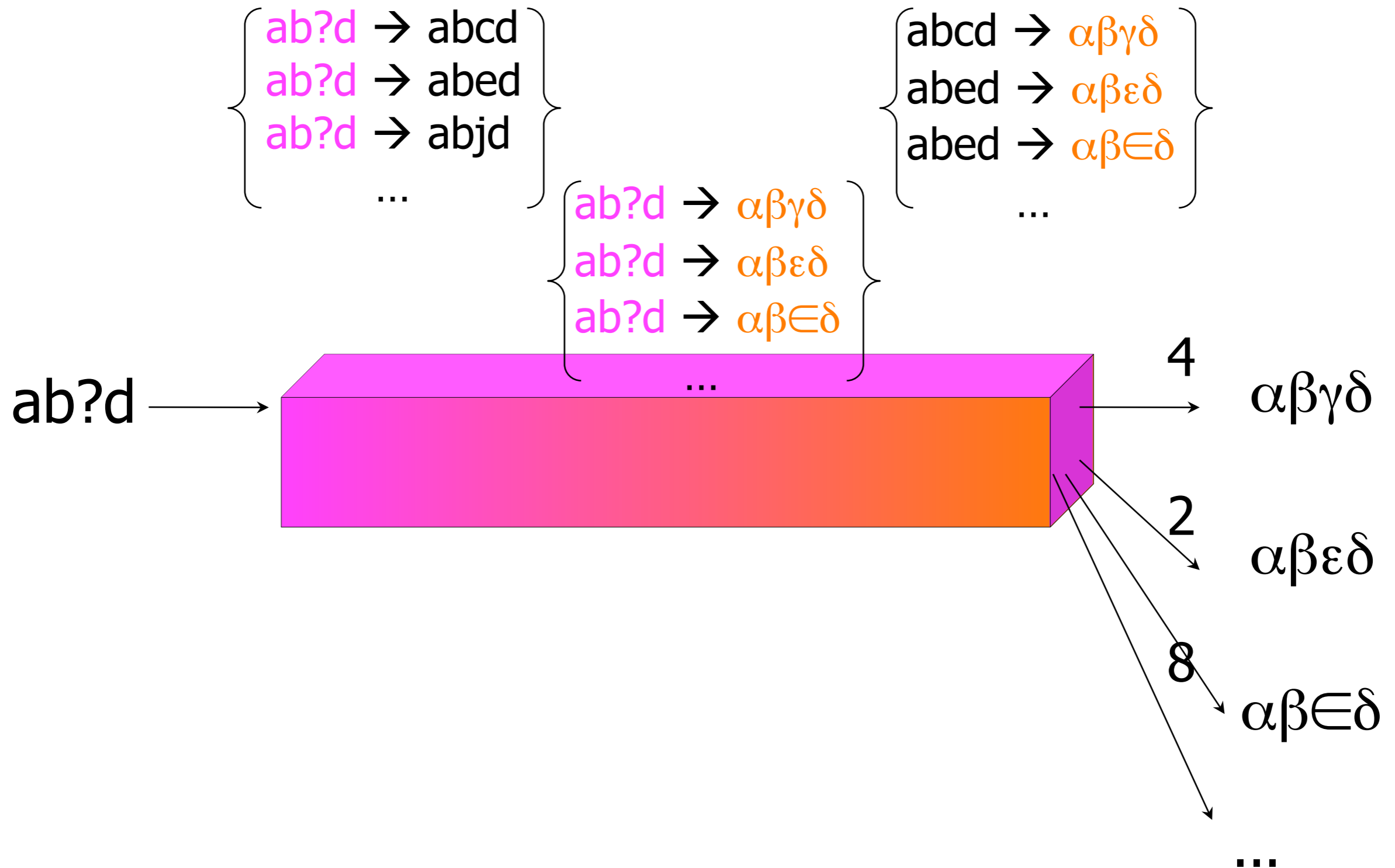

Relation = set of pairs

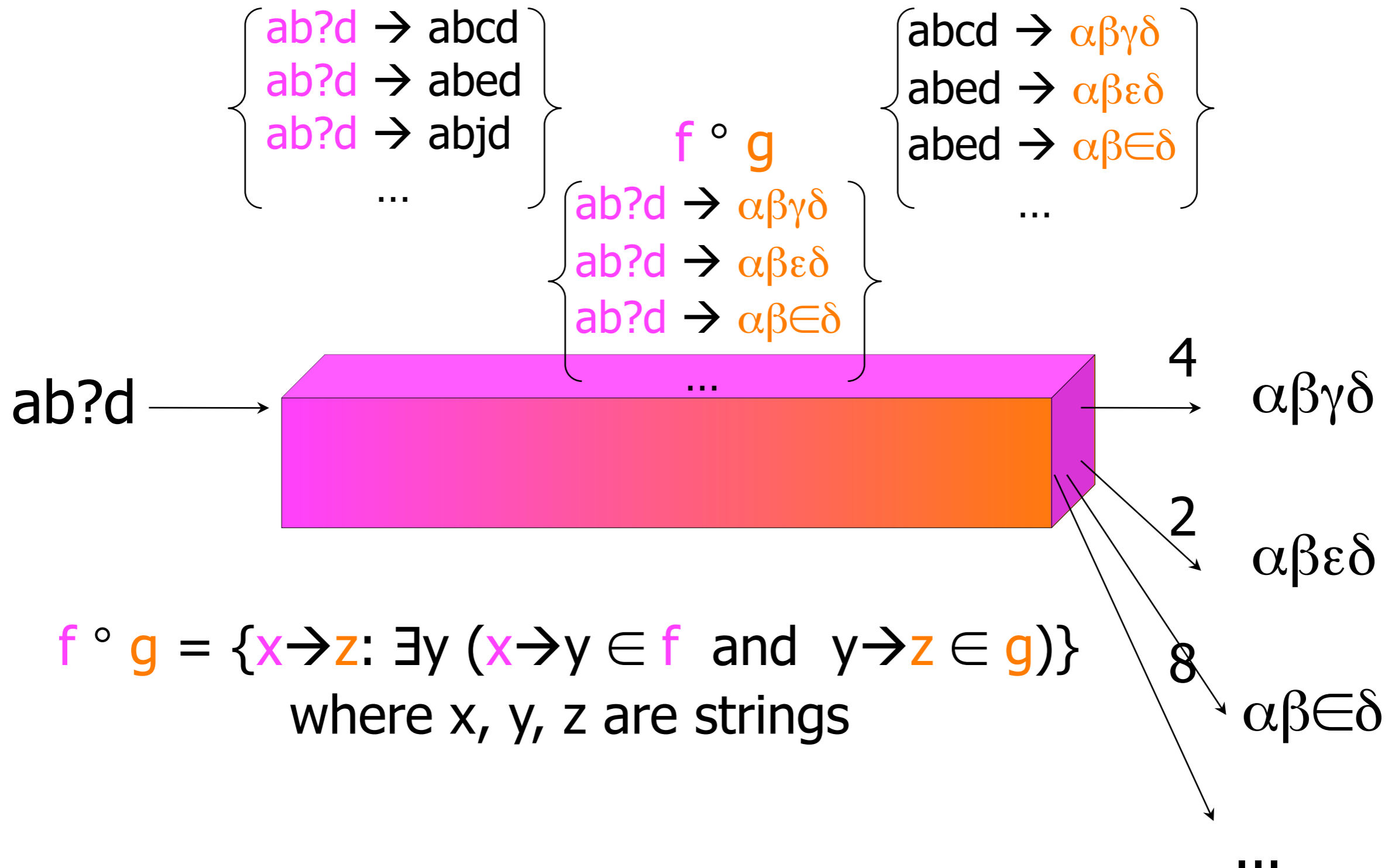

Intersection vs. Composition

Intersection

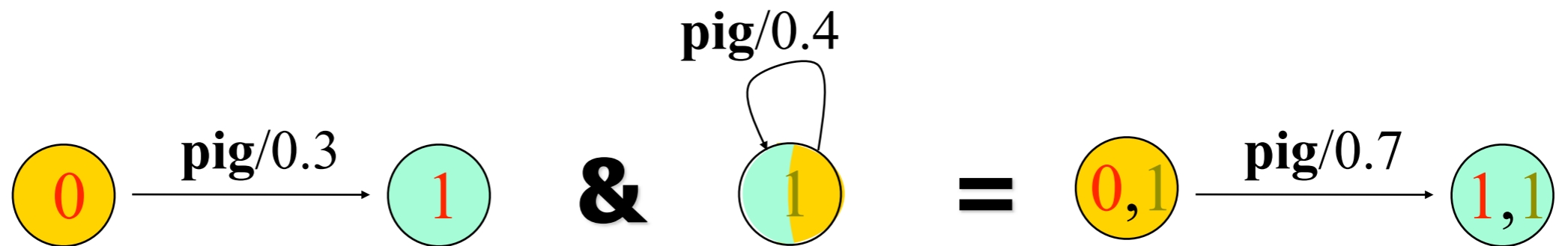

Composition

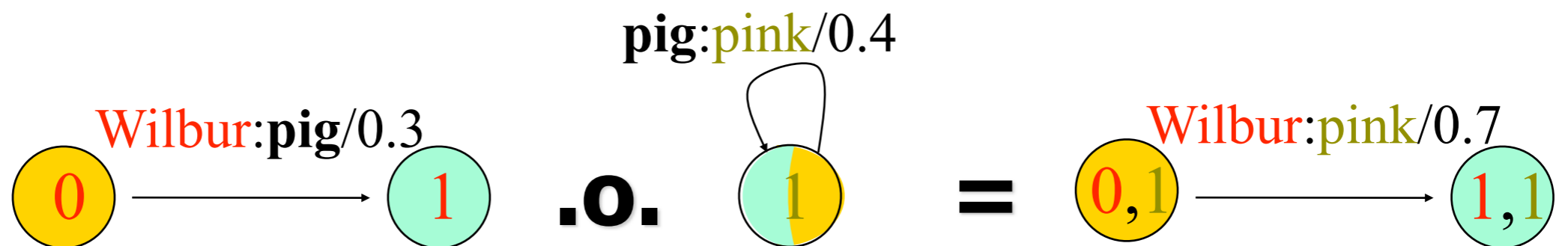

Intersection vs. Composition

Intersection mismatch

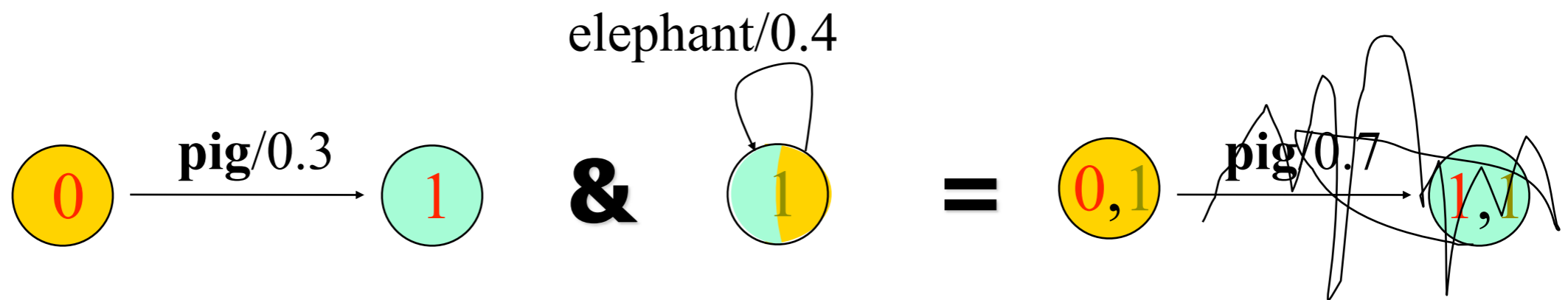

Composition mismatch

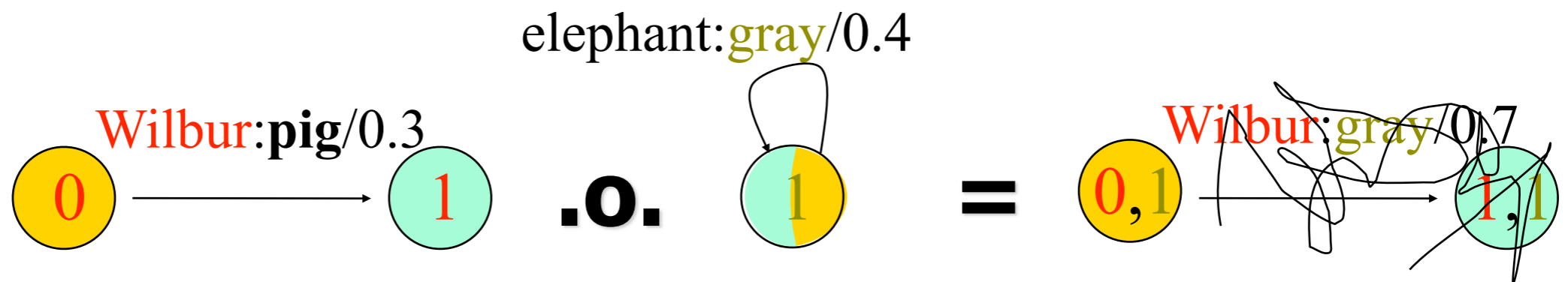

Composition

example courtesy of M. Mohri

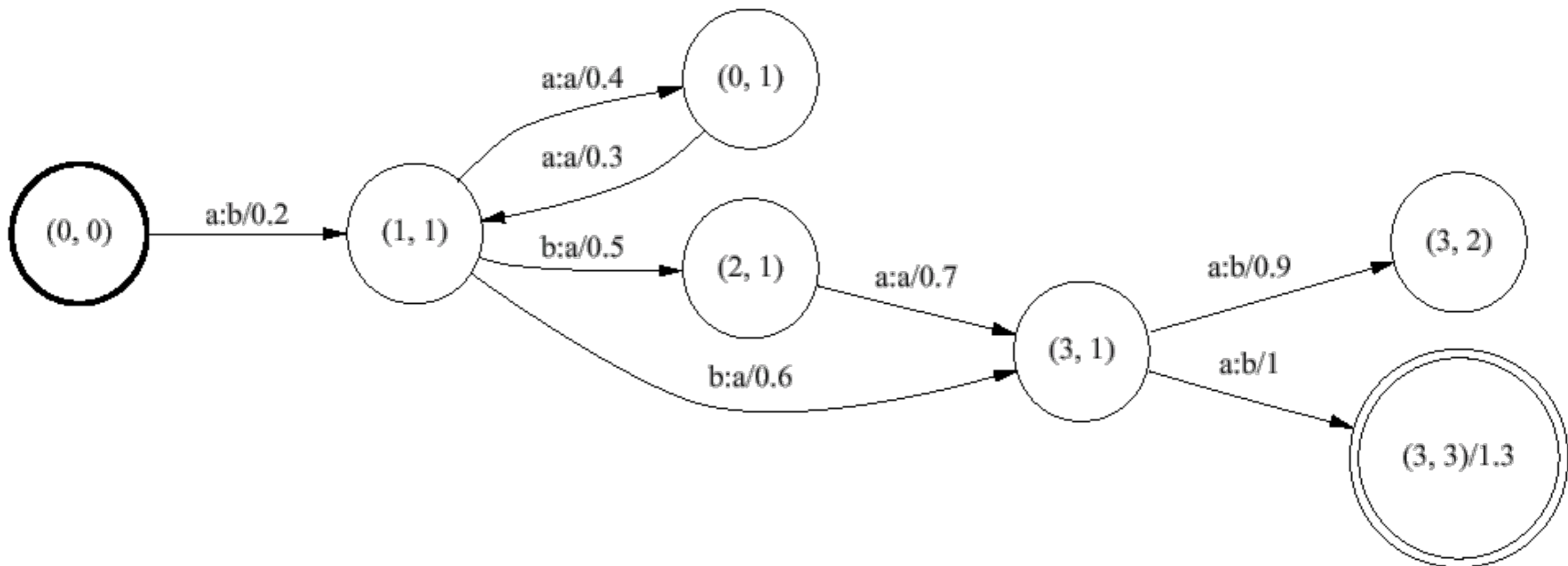
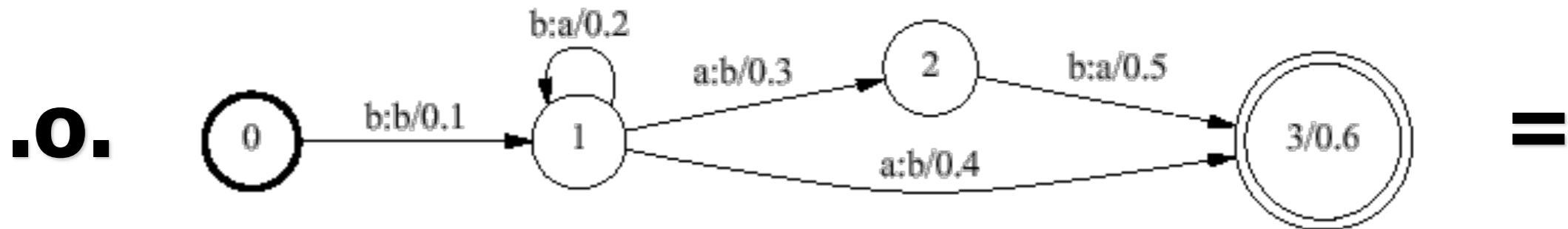
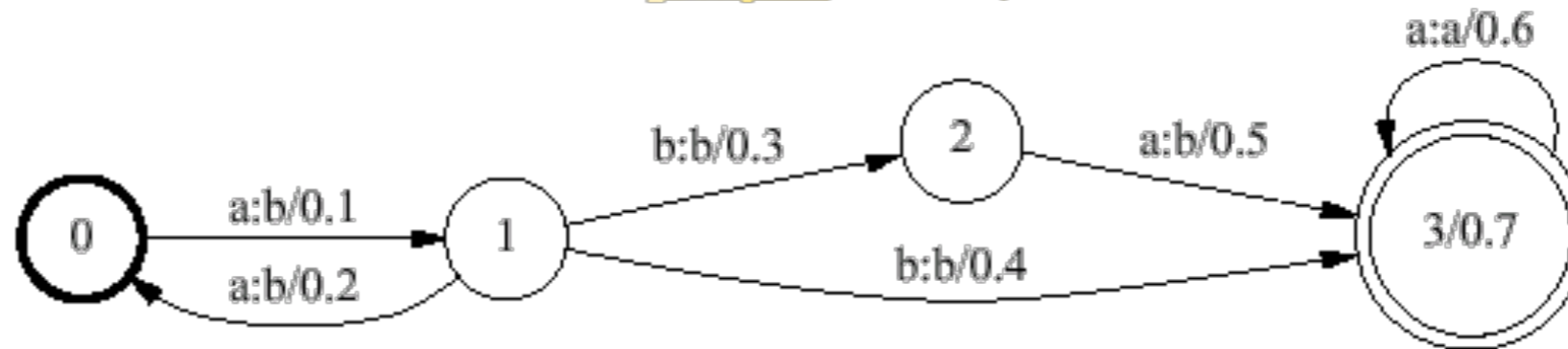

Composition

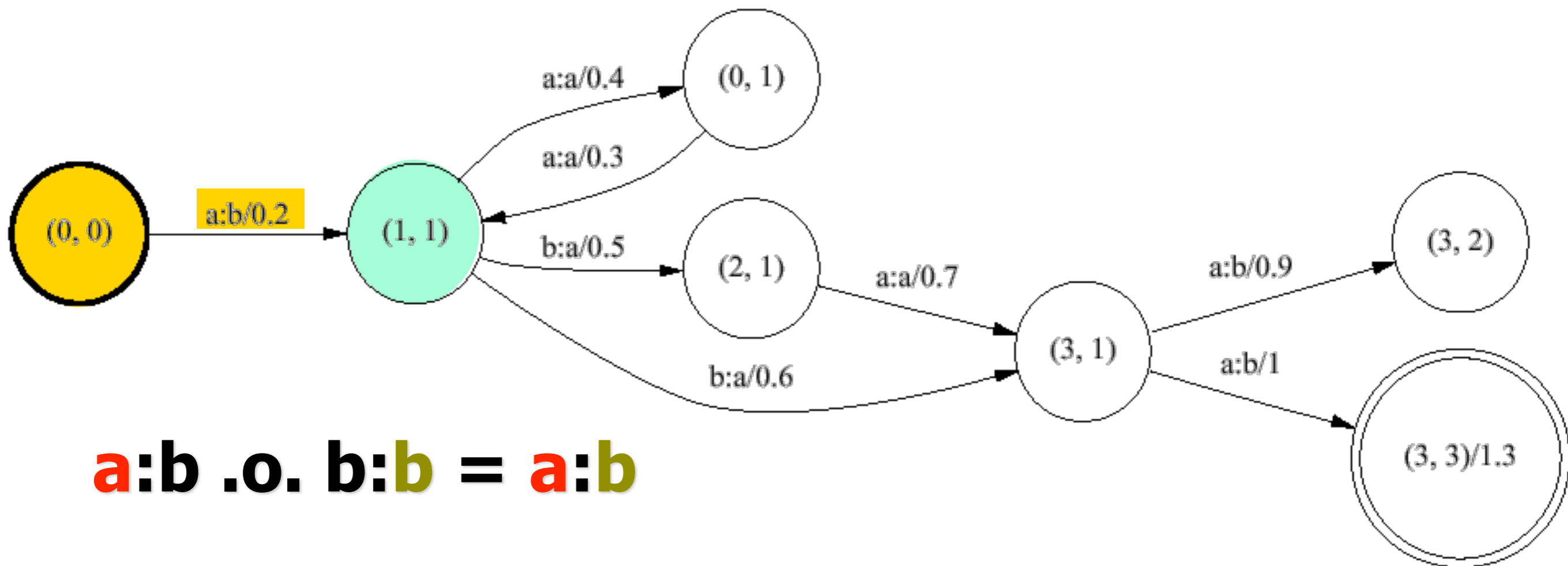
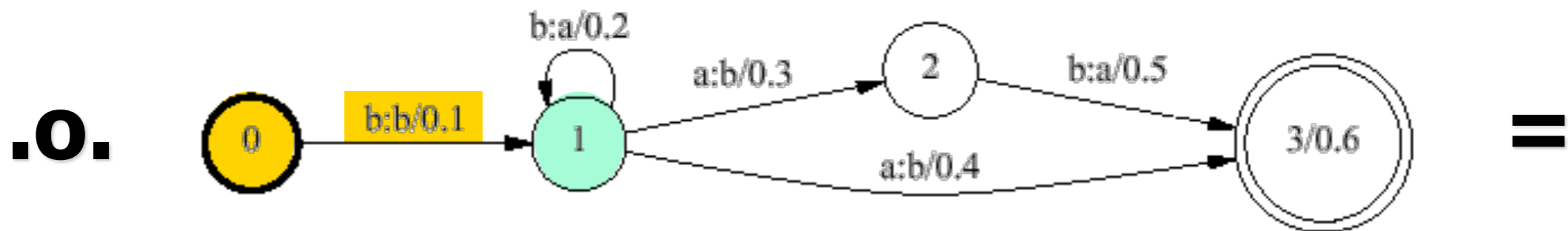
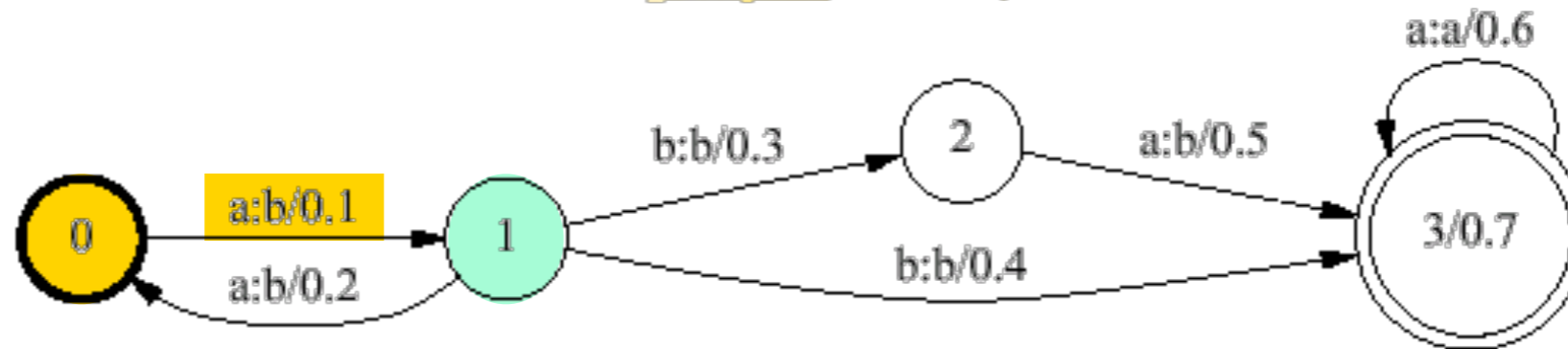

a:b .o. b:b = a:b

Composition

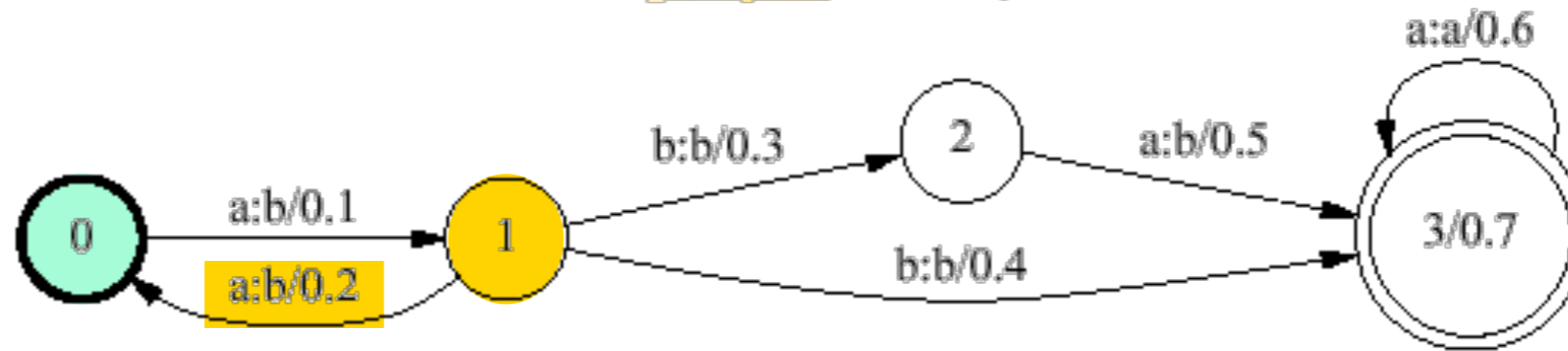

.o.

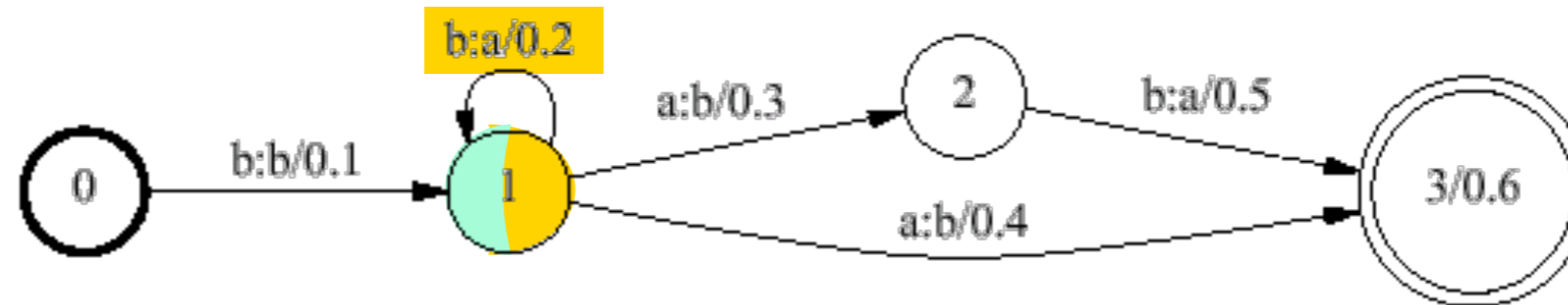

=

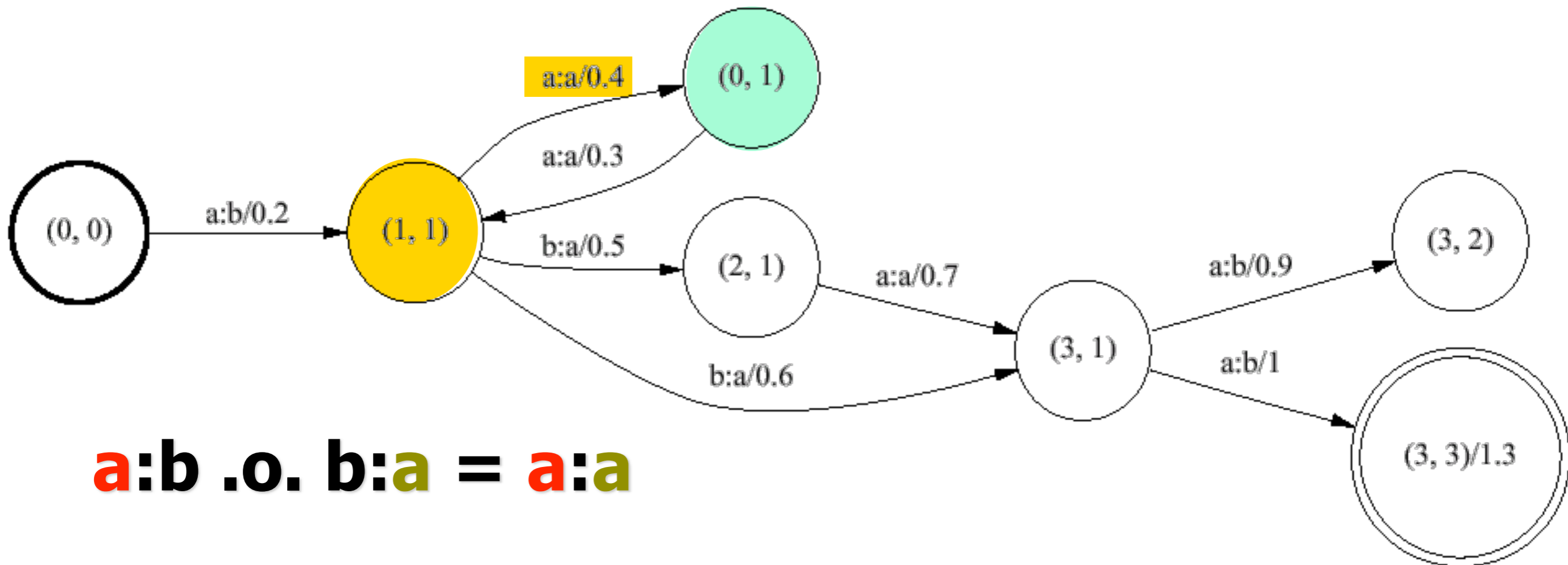

a:b .o. b:a = a:a

Composition

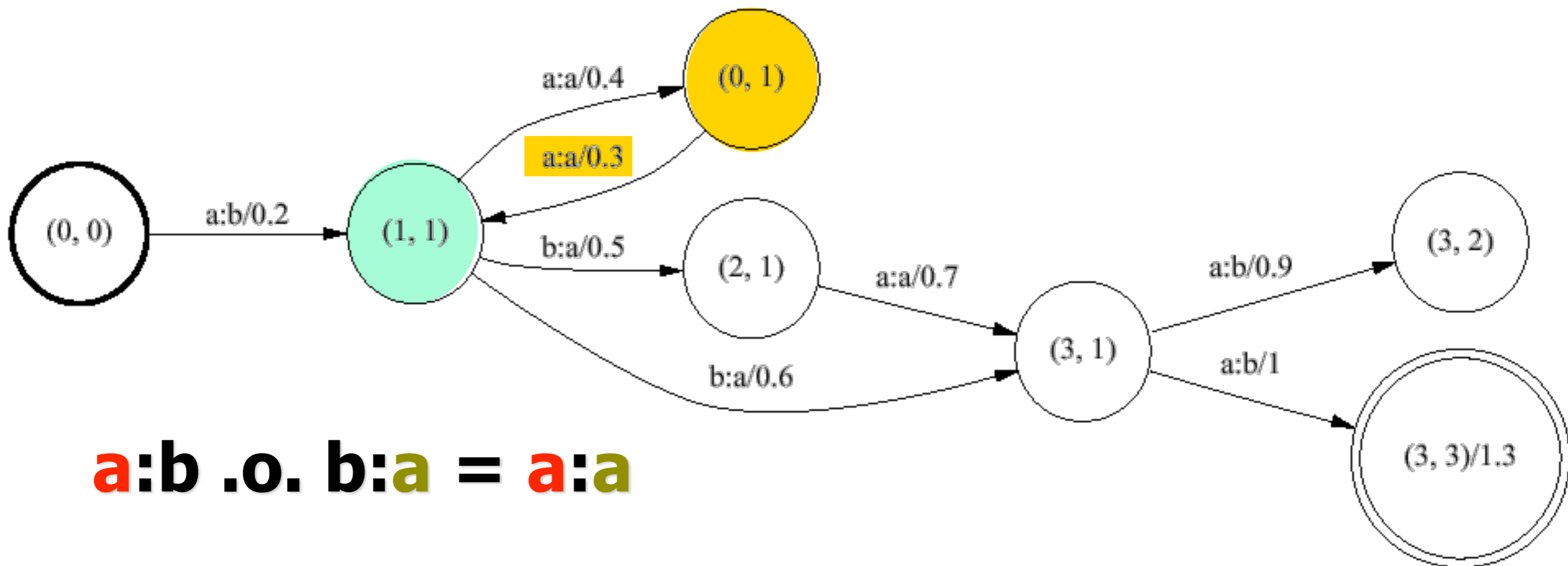
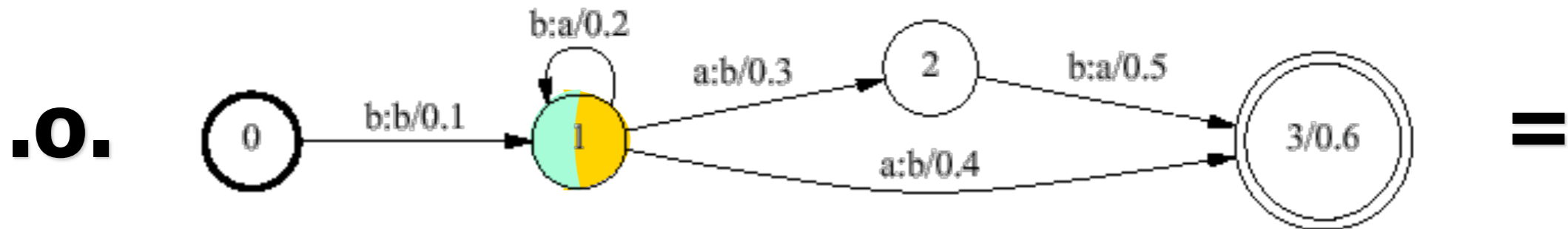
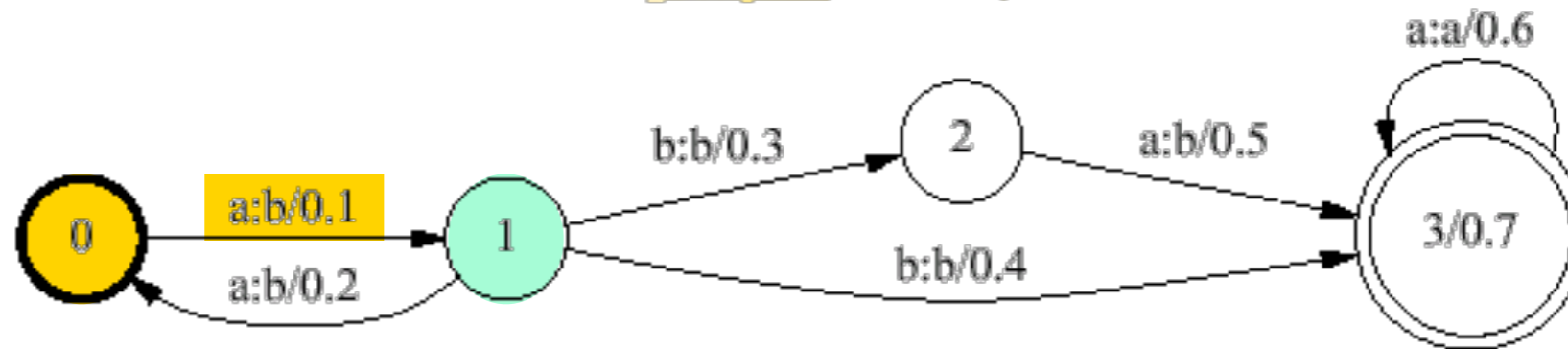

Composition

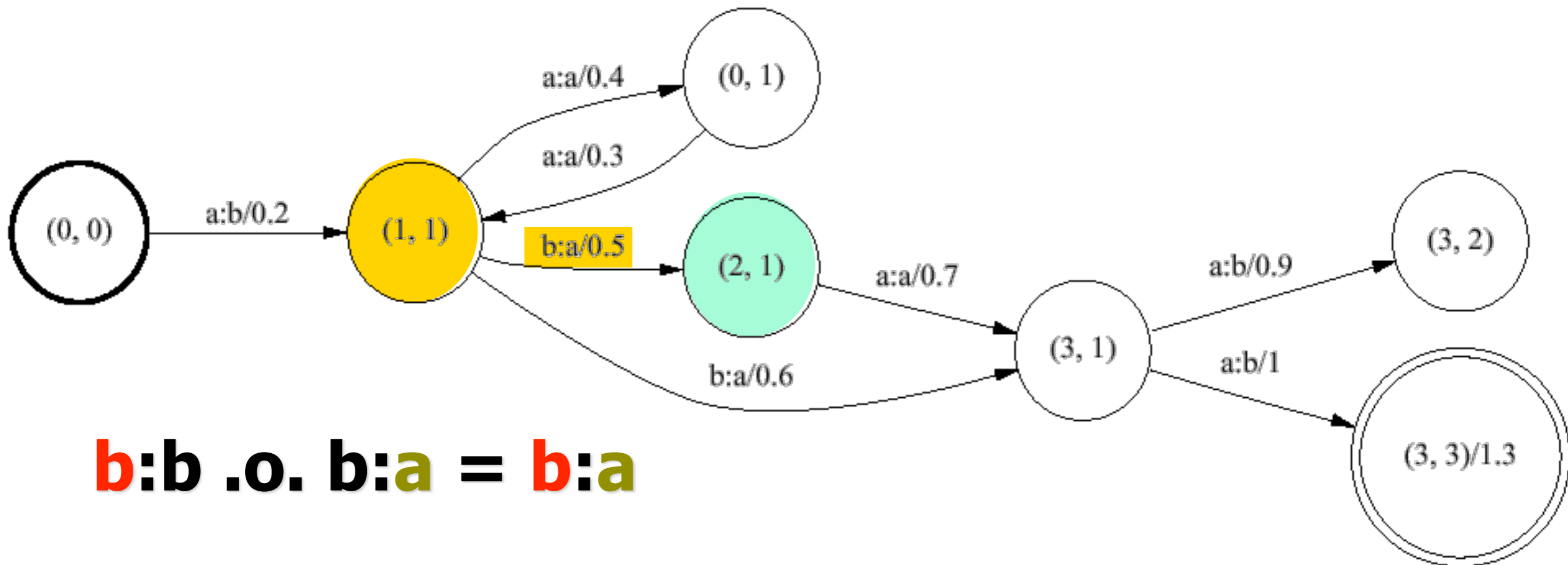
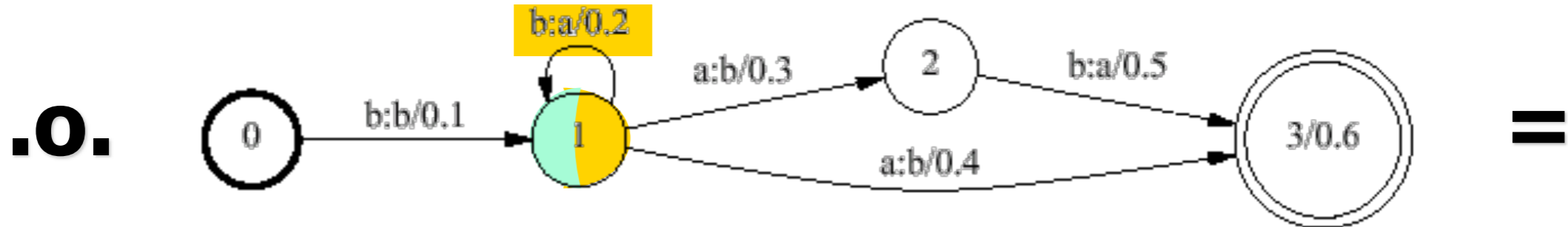
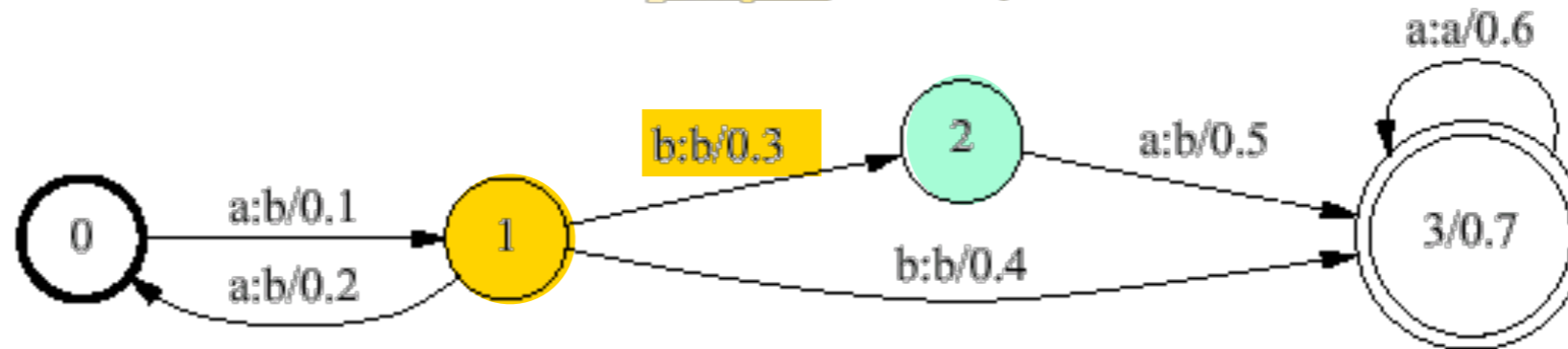

b:b .o. b:a = b:a

Composition

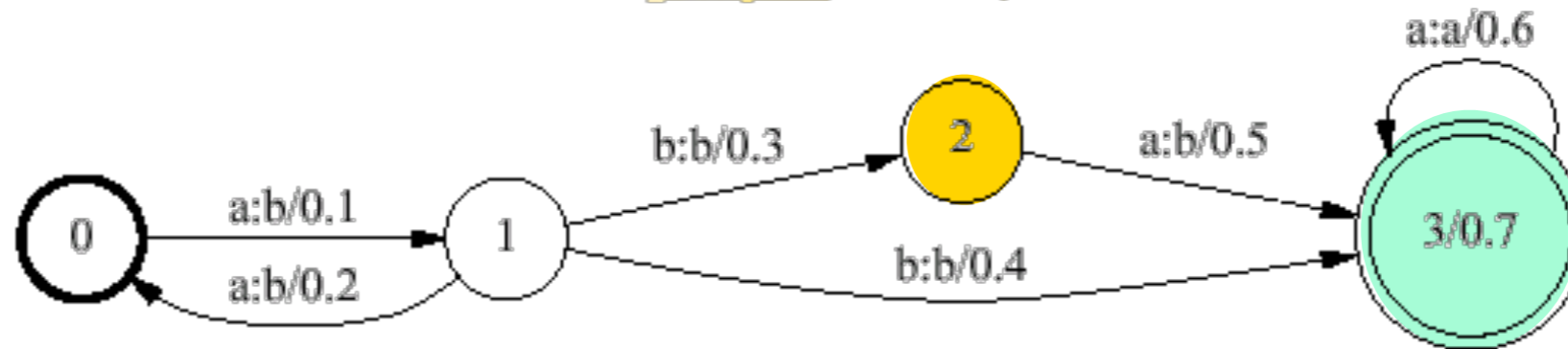

.o.

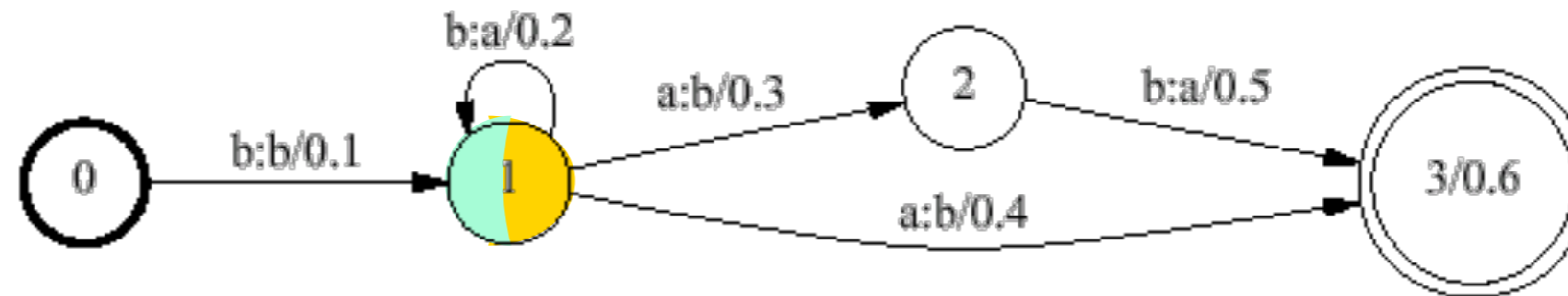

=

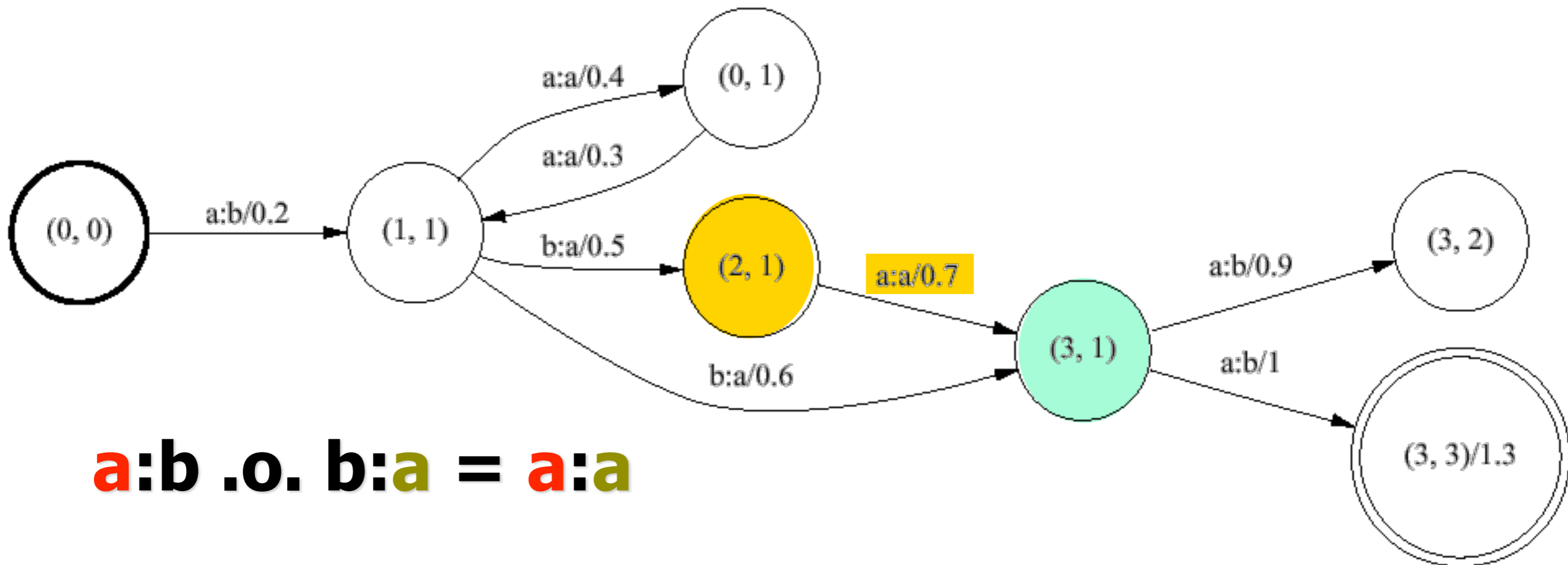

a:b .o. b:a = a:a

Composition

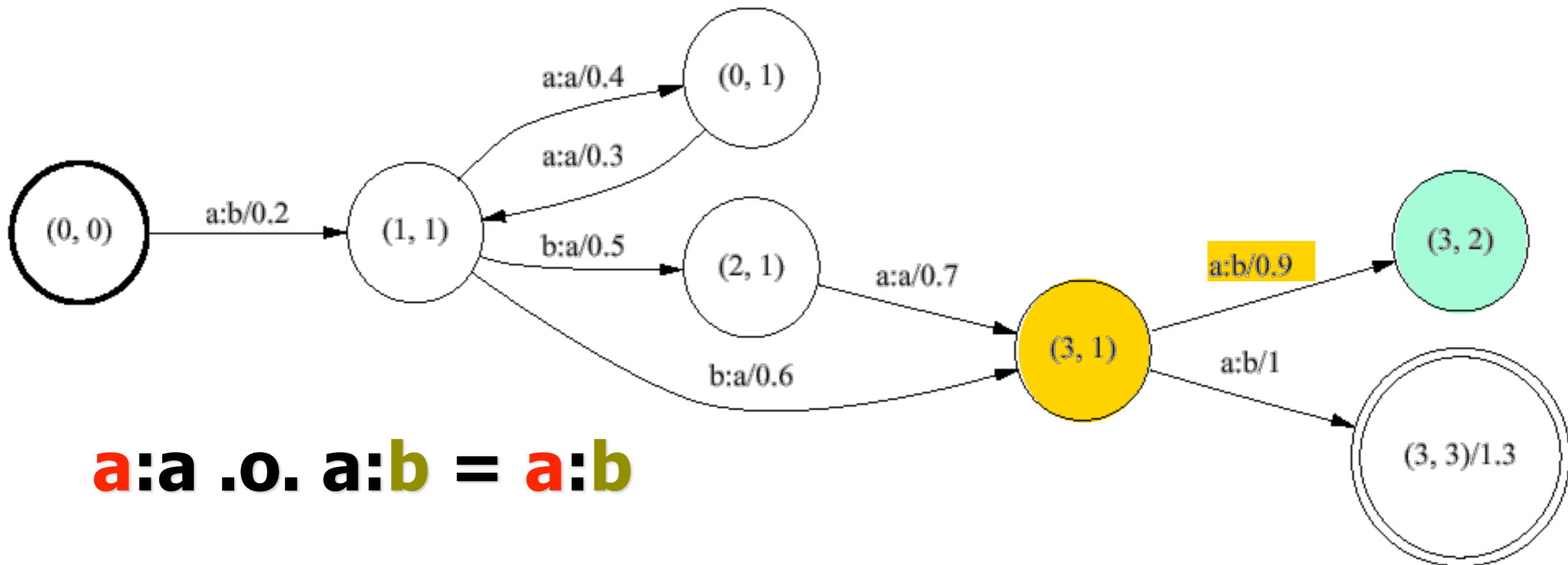
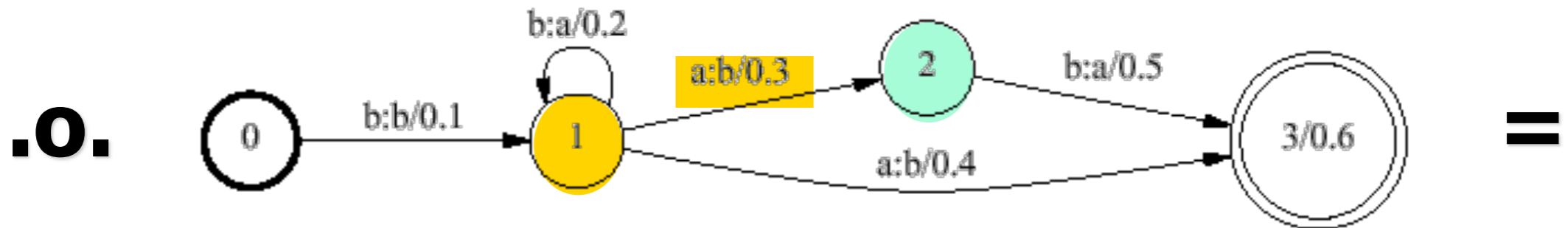
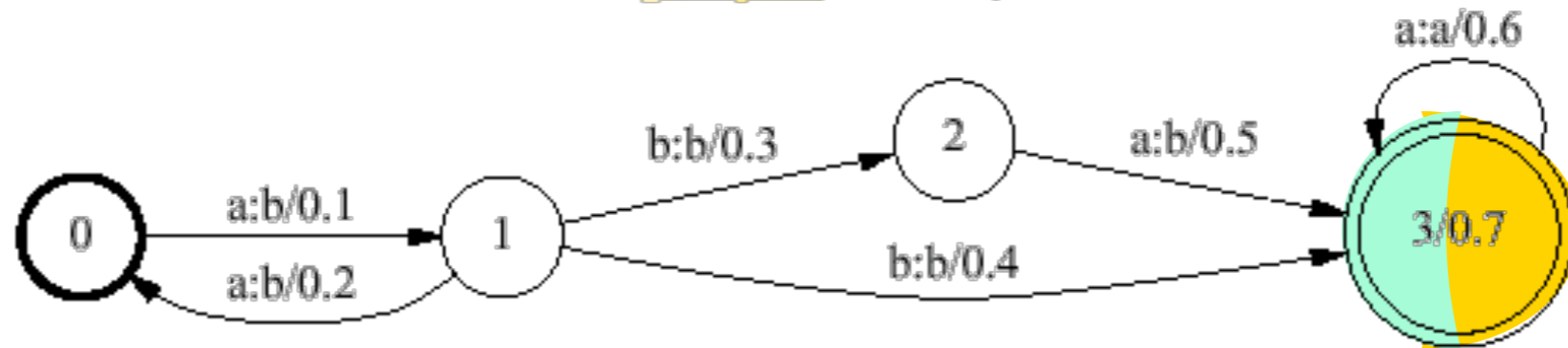

a:a .0. a:b = a:b

Composition

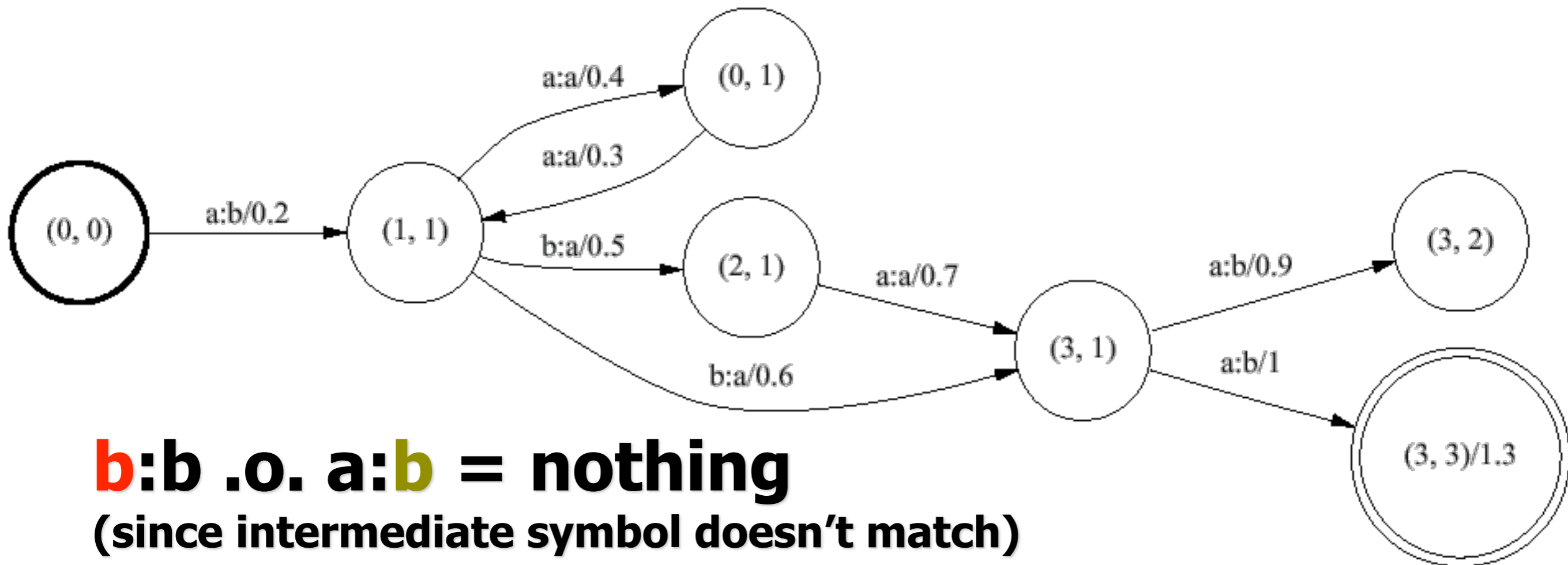
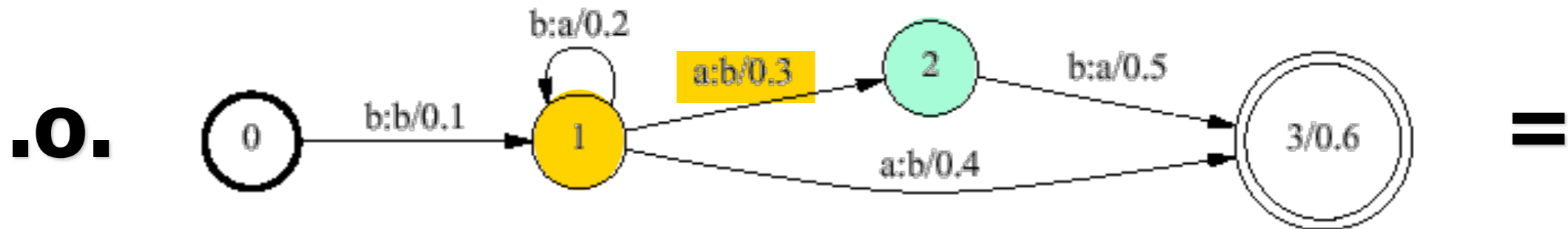
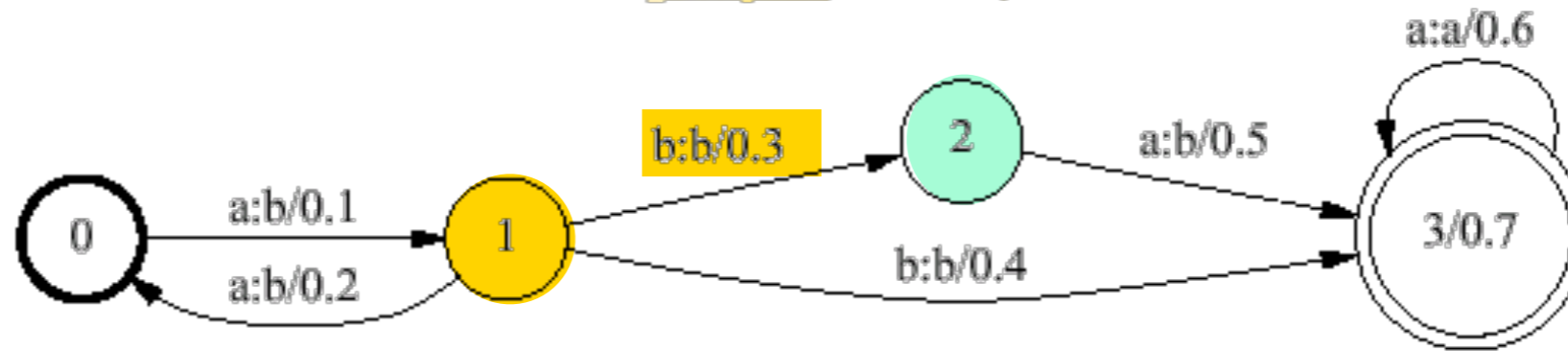

b:b .0. a:b = nothing
(since intermediate symbol doesn't match)

Composition

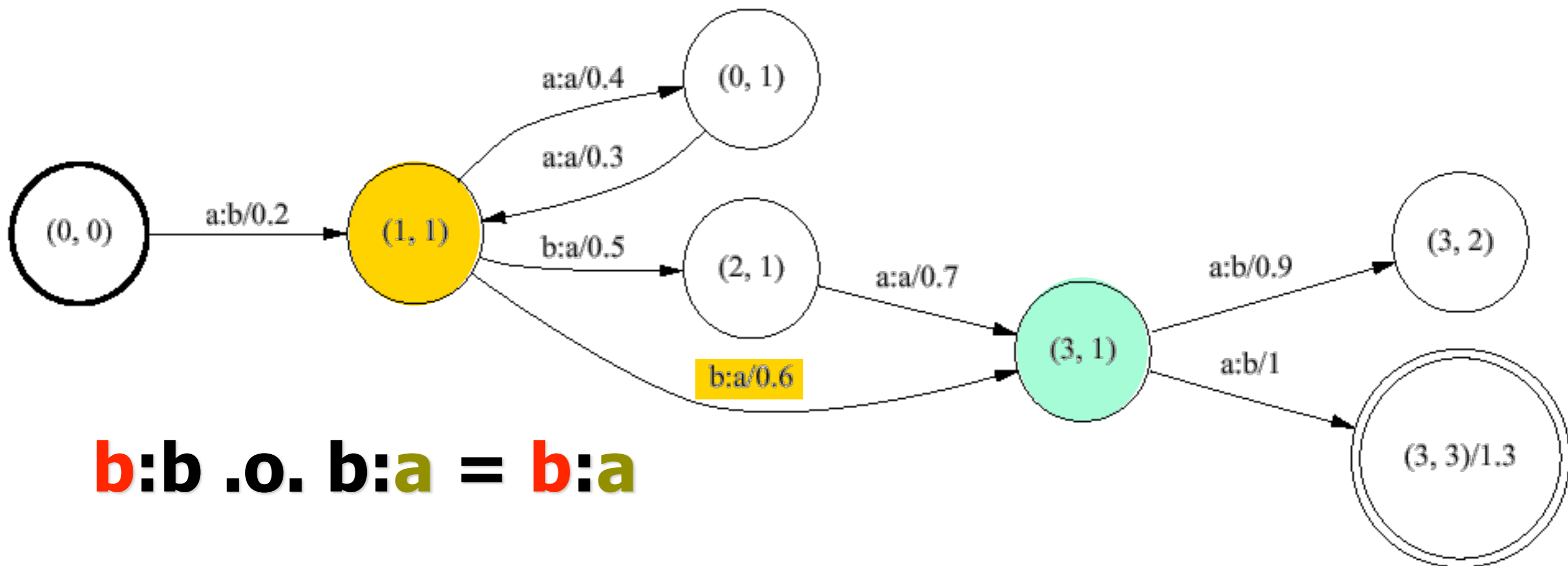
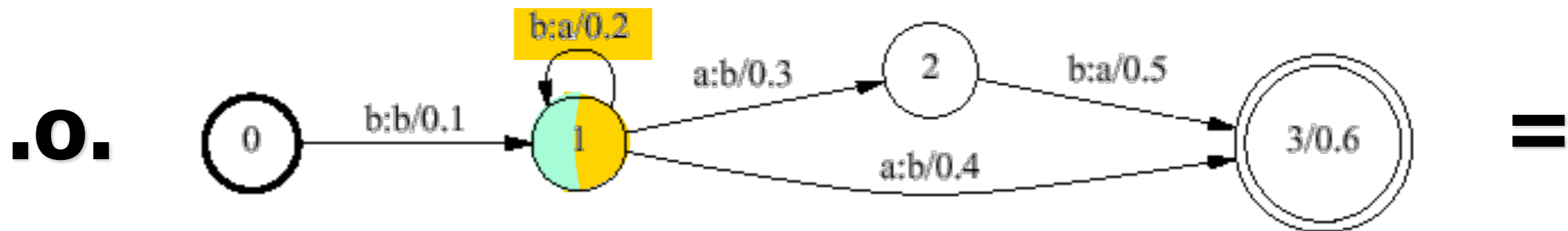
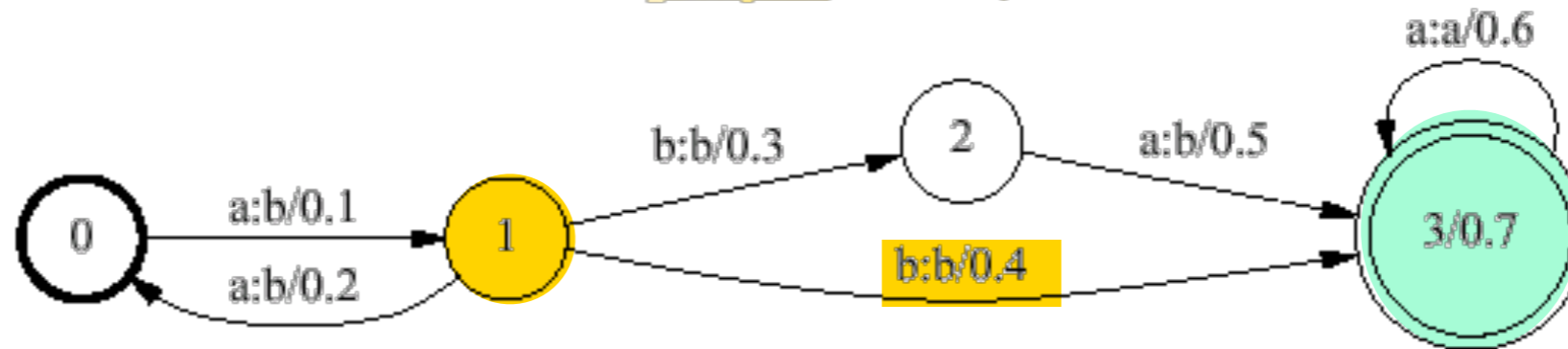

b:b .o. b:a = b:a

Composition

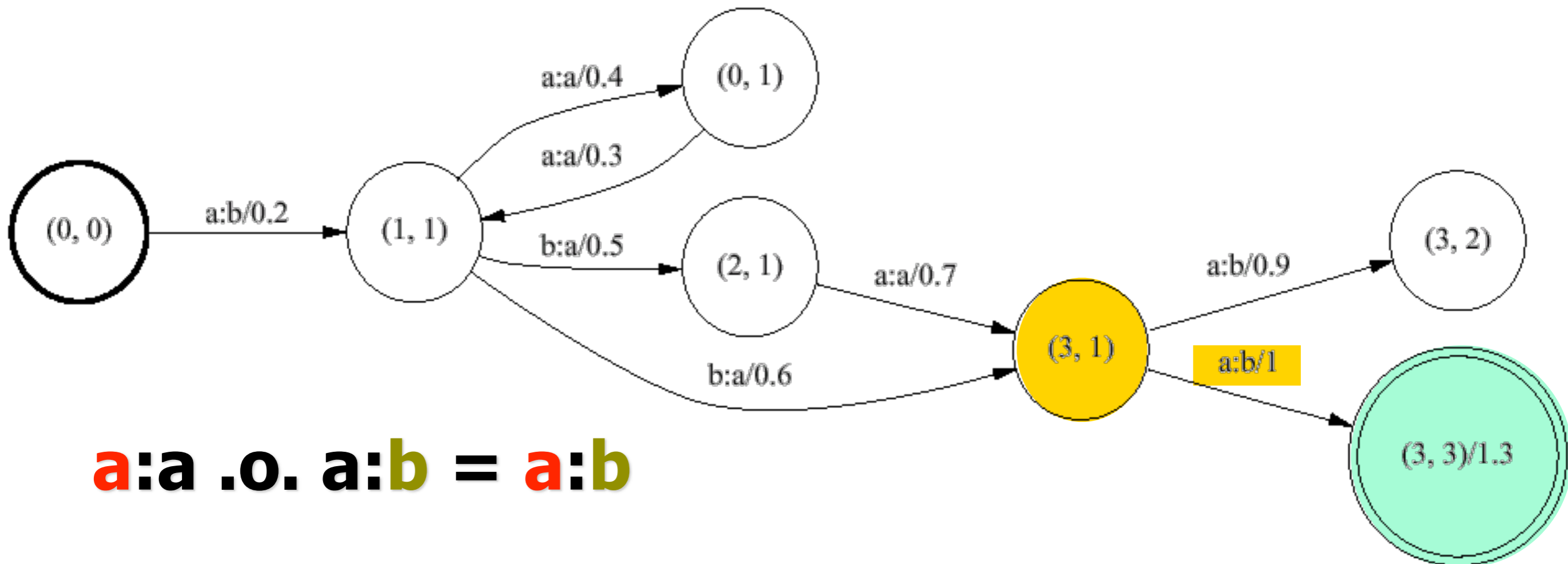
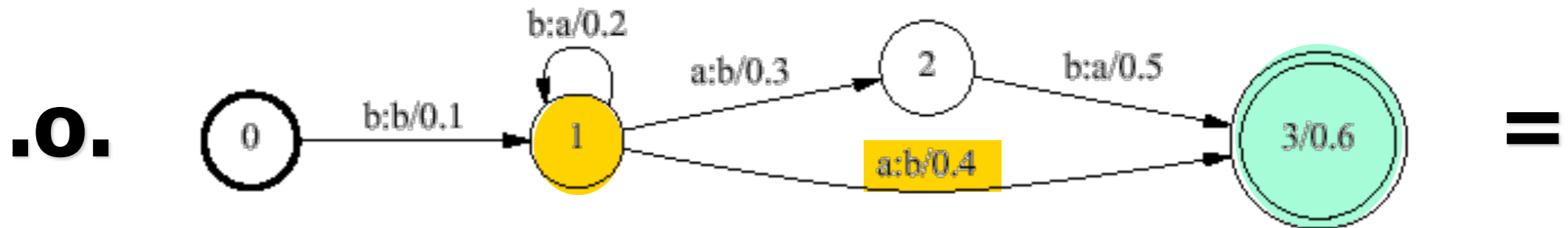
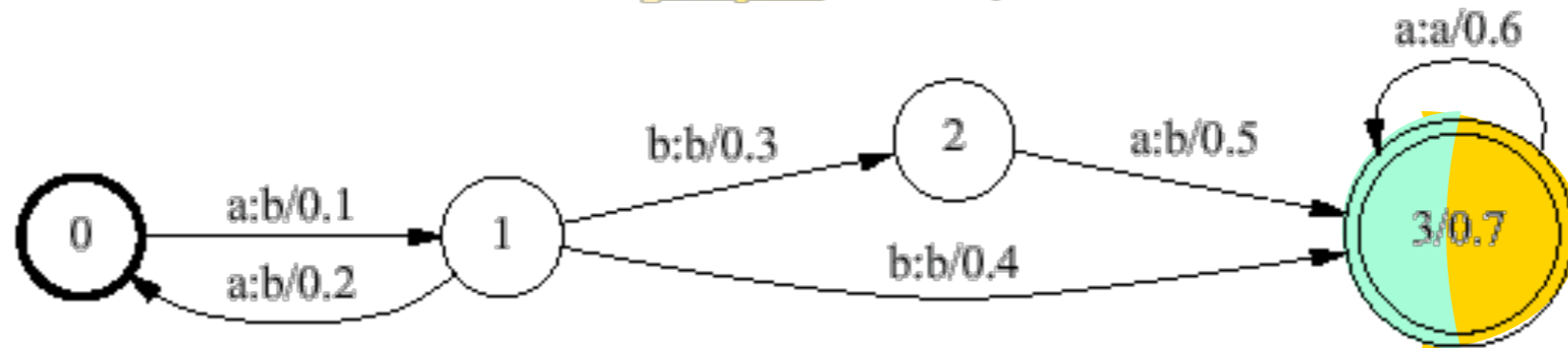

a:a .0. a:b = a:b

Relation = set of pairs

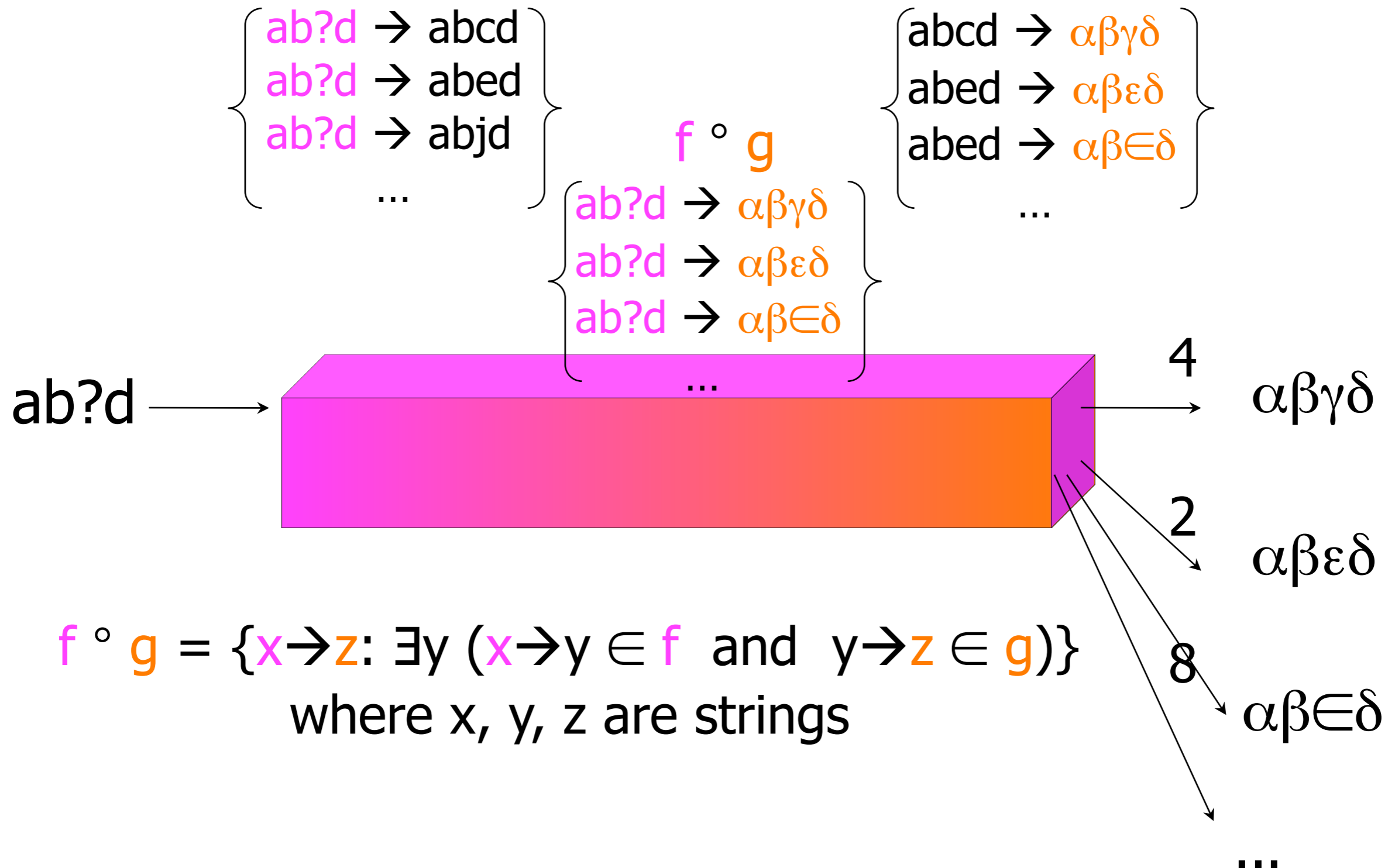

Composition with Sets

Composition with Sets

- We've defined $A \circ B$ where both are FSTs

Composition with Sets

- We've defined $A \circ B$ where both are FSTs
- Now extend definition to allow one to be a FSA

Composition with Sets

- We've defined $A \circ B$ where both are FSTs
- Now extend definition to allow one to be a FSA
- Two relations (FSTs):

$$A \circ B = \{x \rightarrow z : \exists y (x \rightarrow y \in A \text{ and } y \rightarrow z \in B)\}$$

Composition with Sets

- We've defined $A \circ B$ where both are FSTs
- Now extend definition to allow one to be a FSA
- Two relations (FSTs):
$$A \circ B = \{x \rightarrow z : \exists y (x \rightarrow y \in A \text{ and } y \rightarrow z \in B)\}$$
- Set and relation:

Composition with Sets

- We've defined $A \circ B$ where both are FSTs
- Now extend definition to allow one to be a FSA
- Two relations (FSTs):

$$A \circ B = \{x \rightarrow z : \exists y (x \rightarrow y \in A \text{ and } y \rightarrow z \in B)\}$$

- Set and relation:

$$A \circ B = \{x \rightarrow z : x \in A \text{ and } x \rightarrow z \in B\}$$

Composition with Sets

- We've defined $A \circ B$ where both are FSTs
- Now extend definition to allow one to be a FSA
- Two relations (FSTs):

$$A \circ B = \{x \rightarrow z : \exists y (x \rightarrow y \in A \text{ and } y \rightarrow z \in B)\}$$

- Set and relation:

$$A \circ B = \{x \rightarrow z : x \in A \text{ and } x \rightarrow z \in B\}$$

- Relation and set:

$$A \circ B = \{x \rightarrow z : x \rightarrow z \in A \text{ and } z \in B\}$$

Composition with Sets

- We've defined $A \circ B$ where both are FSTs
- Now extend definition to allow one to be a FSA
- Two relations (FSTs):

$$A \circ B = \{x \rightarrow z : \exists y (x \rightarrow y \in A \text{ and } y \rightarrow z \in B)\}$$

- Set and relation:

$$A \circ B = \{x \rightarrow z : x \in A \text{ and } x \rightarrow z \in B\}$$

- Relation and set:

$$A \circ B = \{x \rightarrow z : x \rightarrow z \in A \text{ and } z \in B\}$$

- Two sets (acceptors) – same as intersection:

$$A \circ B = \{x : x \in A \text{ and } x \in B\}$$

Composition and Coercion

- Really just treats a set as identity relation on set

$$\{abc, pqr, \dots\} = \{abc \rightarrow abc, pqr \rightarrow pqr, \dots\}$$

- Two relations (FSTs):

$$A \circ B = \{x \rightarrow z: \exists y (x \rightarrow y \in A \text{ and } y \rightarrow z \in B)\}$$

- Set and relation is now special case (if $\exists y$ then $y=x$):

$$A \circ B = \{x \rightarrow z: x \rightarrow x \in A \text{ and } x \rightarrow z \in B\}$$

- Relation and set is now special case (if $\exists y$ then $y=z$):

- $A \circ B = \{x \rightarrow z: x \rightarrow z \in A \text{ and } z \rightarrow z \in B\}$

- Two sets (acceptors) is now special case:

$$A \circ B = \{x \rightarrow x: x \rightarrow x \in A \text{ and } x \rightarrow x \in B\}$$

3 Uses of Set Composition:

3 Uses of Set Composition:

- **Feed string into Greek transducer:**
-
-

3 Uses of Set Composition:

- **Feed string into Greek transducer:**
 - $\{abed \rightarrow abed\}$.o. Greek = $\{abed \rightarrow \alpha\beta\epsilon\delta, abed \rightarrow \alpha\beta\in\delta\}$
-
-

3 Uses of Set Composition:

- **Feed string into Greek transducer:**
 - $\{abed \rightarrow abed\}$.o. Greek = $\{abed \rightarrow \alpha\beta\varepsilon\delta, abed \rightarrow \alpha\beta\in\delta\}$
 - $\{abed\}$.o. Greek = $\{abed \rightarrow \alpha\beta\varepsilon\delta, abed \rightarrow \alpha\beta\in\delta\}$
-
-

3 Uses of Set Composition:

- **Feed string into Greek transducer:**
 - $\{abed \rightarrow abed\} \cdot o. \text{ Greek} = \{abed \rightarrow \alpha\beta\epsilon\delta, abed \rightarrow \alpha\beta\epsilon\delta\}$
 - $\{abed\} \cdot o. \text{ Greek} = \{abed \rightarrow \alpha\beta\epsilon\delta, abed \rightarrow \alpha\beta\epsilon\delta\}$
 - $[\{abed\} \cdot o. \text{ Greek}].l = \{\alpha\beta\epsilon\delta, \alpha\beta\epsilon\delta\}$
-
-

3 Uses of Set Composition:

- **Feed string into Greek transducer:**
 - $\{abed \rightarrow abed\} \cdot o. \text{ Greek} = \{abed \rightarrow \alpha\beta\epsilon\delta, abed \rightarrow \alpha\beta\epsilon\delta\}$
 - $\{abed\} \cdot o. \text{ Greek} = \{abed \rightarrow \alpha\beta\epsilon\delta, abed \rightarrow \alpha\beta\epsilon\delta\}$
 - $[\{abed\} \cdot o. \text{ Greek}].l = \{\alpha\beta\epsilon\delta, \alpha\beta\epsilon\delta\}$

- **Feed several strings in parallel:**

3 Uses of Set Composition:

- **Feed string into Greek transducer:**

- $\{abed \rightarrow abed\} \cdot o. \text{ Greek} = \{abed \rightarrow \alpha\beta\epsilon\delta, abed \rightarrow \alpha\beta\epsilon\delta\}$

- $\{abed\} \cdot o. \text{ Greek} = \{abed \rightarrow \alpha\beta\epsilon\delta, abed \rightarrow \alpha\beta\epsilon\delta\}$

- $[\{abed\} \cdot o. \text{ Greek}] \cdot l = \{\alpha\beta\epsilon\delta, \alpha\beta\epsilon\delta\}$

- **Feed several strings in parallel:**

- $\{abcd, abed\} \cdot o. \text{ Greek}$
 $= \{abcd \rightarrow \alpha\beta\gamma\delta, abed \rightarrow \alpha\beta\epsilon\delta, abed \rightarrow \alpha\beta\epsilon\delta\}$

3 Uses of Set Composition:

- **Feed string into Greek transducer:**

- $\{abed \rightarrow abed\} \cdot o. \text{ Greek} = \{abed \rightarrow \alpha\beta\epsilon\delta, abed \rightarrow \alpha\beta\epsilon\delta\}$
- $\{abed\} \cdot o. \text{ Greek} = \{abed \rightarrow \alpha\beta\epsilon\delta, abed \rightarrow \alpha\beta\epsilon\delta\}$
- $[\{abed\} \cdot o. \text{ Greek}].l = \{\alpha\beta\epsilon\delta, \alpha\beta\epsilon\delta\}$

- **Feed several strings in parallel:**

- $\{abcd, abed\} \cdot o. \text{ Greek} = \{abcd \rightarrow \alpha\beta\gamma\delta, abed \rightarrow \alpha\beta\epsilon\delta, abed \rightarrow \alpha\beta\epsilon\delta\}$
- $[\{abcd, abed\} \cdot o. \text{ Greek}].l = \{\alpha\beta\gamma\delta, \alpha\beta\epsilon\delta, \alpha\beta\epsilon\delta\}$

3 Uses of Set Composition:

- **Feed string into Greek transducer:**

- $\{abed \rightarrow abed\} \cdot o. \text{ Greek} = \{abed \rightarrow \alpha\beta\epsilon\delta, abed \rightarrow \alpha\beta\epsilon\delta\}$
- $\{abed\} \cdot o. \text{ Greek} = \{abed \rightarrow \alpha\beta\epsilon\delta, abed \rightarrow \alpha\beta\epsilon\delta\}$
- $[\{abed\} \cdot o. \text{ Greek}].l = \{\alpha\beta\epsilon\delta, \alpha\beta\epsilon\delta\}$

- **Feed several strings in parallel:**

- $\{abcd, abed\} \cdot o. \text{ Greek} = \{abcd \rightarrow \alpha\beta\gamma\delta, abed \rightarrow \alpha\beta\epsilon\delta, abed \rightarrow \alpha\beta\epsilon\delta\}$
- $[\{abcd, abed\} \cdot o. \text{ Greek}].l = \{\alpha\beta\gamma\delta, \alpha\beta\epsilon\delta, \alpha\beta\epsilon\delta\}$

- **Filter result via $No_\epsilon = \{\alpha\beta\gamma\delta, \alpha\beta\epsilon\delta, \dots\}$**

3 Uses of Set Composition:

- **Feed string into Greek transducer:**

- $\{abed \rightarrow abed\} \cdot_o \text{Greek} = \{abed \rightarrow \alpha\beta\epsilon\delta, abed \rightarrow \alpha\beta\epsilon\delta\}$
- $\{abed\} \cdot_o \text{Greek} = \{abed \rightarrow \alpha\beta\epsilon\delta, abed \rightarrow \alpha\beta\epsilon\delta\}$
- $[\{abed\} \cdot_o \text{Greek}] \cdot_l = \{\alpha\beta\epsilon\delta, \alpha\beta\epsilon\delta\}$

- **Feed several strings in parallel:**

- $\{abcd, abed\} \cdot_o \text{Greek} = \{abcd \rightarrow \alpha\beta\gamma\delta, abed \rightarrow \alpha\beta\epsilon\delta, abed \rightarrow \alpha\beta\epsilon\delta\}$
- $[\{abcd, abed\} \cdot_o \text{Greek}] \cdot_l = \{\alpha\beta\gamma\delta, \alpha\beta\epsilon\delta, \alpha\beta\epsilon\delta\}$

- **Filter result via $\text{No}_\epsilon = \{\alpha\beta\gamma\delta, \alpha\beta\epsilon\delta, \dots\}$**

- $\{abcd, abed\} \cdot_o \text{Greek} \cdot_o \text{No}_\epsilon = \{abcd \rightarrow \alpha\beta\gamma\delta, abed \rightarrow \alpha\beta\epsilon\delta\}$

What are the “basic” transducers?

- The operations on the previous slides combine transducers into bigger ones
- But where do we start?

- $a:\varepsilon$ for $a \in \Sigma$

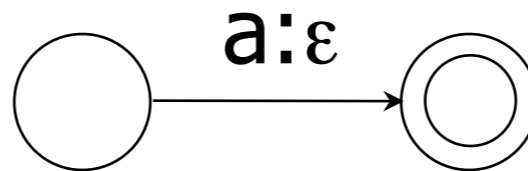

- $\varepsilon:X$ for $X \in \Delta$

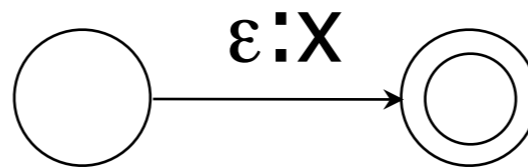

- **Q:** Do we also need $a:X$? How about $\varepsilon:\varepsilon$?