

Why NLP?

Natural Language Processing
CS 4120/6120—Spring 2016
Northeastern University

David Smith

Codes

following

finding

klpsh

3m573

v4p12

CAPTCHA

Completely Automated Public Turing test to tell
Computers and Humans Apart

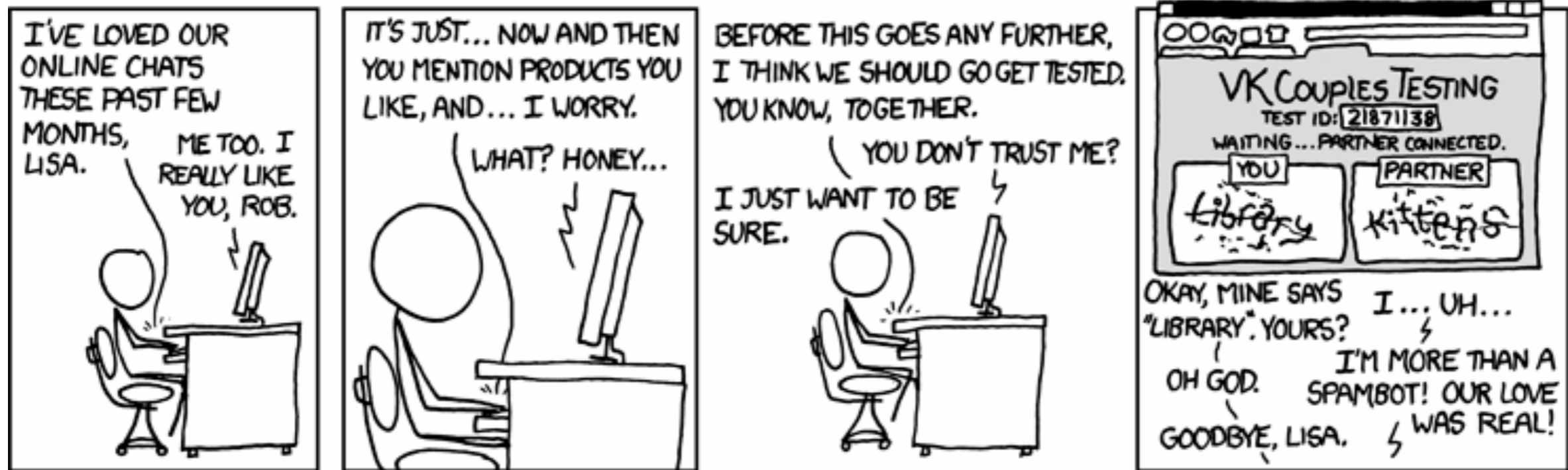

Fine, walk away. I'm gonna go cry into a pint of Ben&Jerry's Brownie Batter(tm) ice cream [link], then take out my frustration on a variety of great flash games from PopCap Games(r) [link].





Warren Weaver
to Norbert Wiener
4 March 1947

One thing I wanted to ask you about is this. A most serious problem, for UNESCO and for the constructive and peaceful future of the planet, is the problem of translation, as it unavoidably affects the communication between peoples. Huxley has recently told me that they are appalled by the magnitude and the importance of the translation job.

Recognizing fully, even though necessarily vaguely, the semantic difficulties because of multiple meanings, etc., I have wondered if it were unthinkable to design a computer which would translate. Even if it would translate only scientific material (where the semantic difficulties are very notably less), and even if it did produce an inelegant (but intelligible) result, it would seem to me worth while.

Also knowing nothing official about, but having guessed and inferred considerable about, powerful new mechanized methods in cryptography—methods which I believe succeed even when one does not know what language has been coded—one naturally wonders if the problem of translation could conceivably be treated as a problem in cryptography. When I look at an article in Russian, I say: “This is really written in English, but it has been coded in some strange symbols. I will now proceed to decode.”



ON COMPUTABLE NUMBERS, WITH AN APPLICATION TO THE ENTSCHIEDUNGSPROBLEM

By A. M. TURING.

[Received 28 May, 1936.—Read 12 November, 1936.]

The “computable” numbers may be described briefly as the real numbers whose expressions as a decimal are calculable by finite means. Although the subject of this paper is ostensibly the computable *numbers*, it is almost equally easy to define and investigate computable functions of an integral variable or a real or computable variable, computable predicates, and so forth. The fundamental problems involved are, however, the same in each case, and I have chosen the computable numbers for explicit treatment as involving the least cumbersome technique. I hope shortly to give an account of the relations of the computable numbers, functions, and so forth to one another. This will include a development of the theory of functions of a real variable expressed in terms of computable numbers. According to my definition, a number is computable if its decimal can be written down by a machine.

In §§ 9, 10 I give some arguments with the intention of showing that the

with the *m*-configuration written below the scanned symbol. The successive complete configurations are separated by colons.

:	e	e	0	0	:	e	e	0	0	:	e	e	0	0	1	:		
b	v			q				q			q	.			p			
e	e	0	0	1	:	e	e	0	0	1	:	e	e	0	0	1	:	
	p			p				f			f							
e	e	0	0	1	:	e	e	0	0	1	:	e	e	0	0	1	0	:
				f				f			v							
e	e	0	0	1	x	0	:										
								e										

This table could also be written in the form

b : e e v 0 0 : e e q 0 0 : (C)

ON COMPUTABLE NUMBERS, WITH AN APPLICATION TO THE ENTSCHIEDUNGSPROBLEM

By A. M. TURING.

[Received 28 May, 1936.—Read 12 November, 1936.]

The “computable” numbers may be described briefly as the real numbers whose expressions as a decimal are calculable by finite means. Although the subject of this paper is ostensibly the computable *numbers*, it is almost equally easy to define and investigate computable functions of an integral variable or a real or computable variable, computable predicates, and so forth. The fundamental problems involved are, however, the same in each case, and I have chosen the computable numbers for explicit treatment as involving the least cumbersome technique. I hope shortly to give an account of the relations of the computable numbers, functions, and so forth to one another. This will include a development of the theory of functions of a real variable expressed in terms of computable numbers. According to my definition, a number is computable if its decimal can be written down by a machine.

In §§ 9, 10 I give some arguments with the intention of showing that the

with the *m*-configuration written below the scanned symbol. The successive complete configurations are separated by colons.

:	e	e	0	0	:	e	e	0	0	:	e	e	0	0	1	:			
b	v			q				q			q	.				p			
e	e	0	0	1	:	e	e	0	0	1	:	e	e	0	0	1	:		
	p			p				f			f								
e	e	0	0	1	:	e	e	0	0	1	:	e	e	0	0	1	0	:	
				f				f			v								
e	e	0	0	1	x	0	:											

This table could also be written in the form

b : e e v 0 0 : e e q 0 0 : (C)





Broderick, BM 1011766-0220-12A
Feb. 1945, Bess (Bess) 11420 144 - Jan

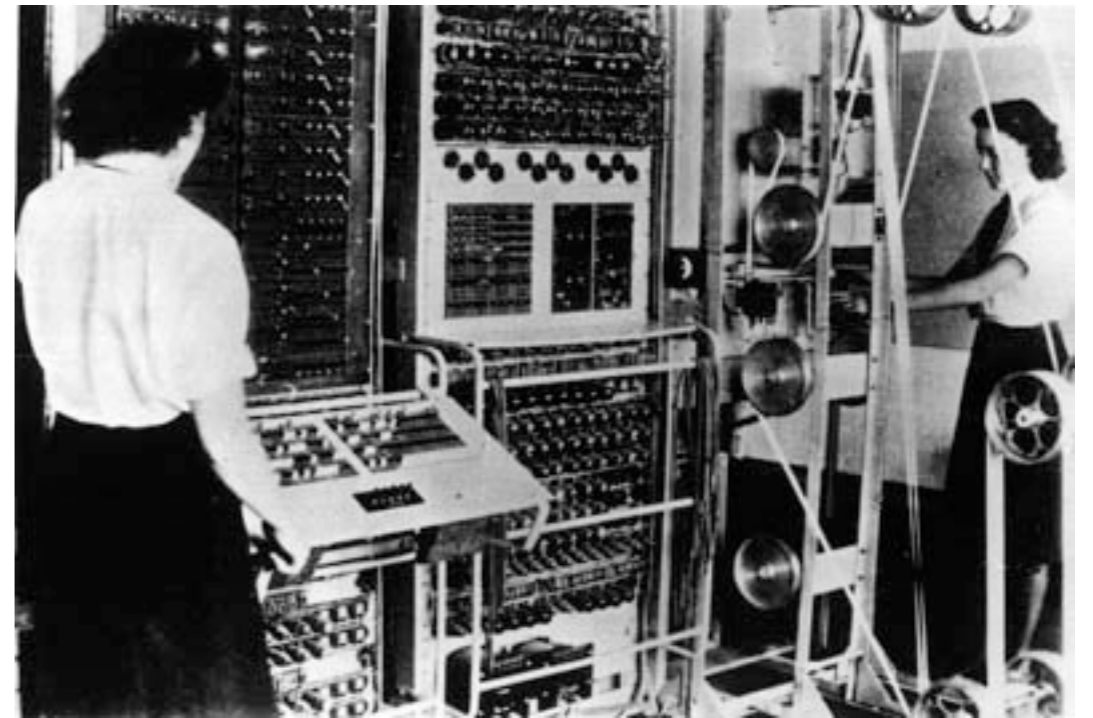

PAUL KIPARSKY

TENSE AND MOOD IN INDO-EUROPEAN SYNTAX*

1. THE HISTORICAL PRESENT

The 'historical' or 'dramatic' present tense used in narrating past events, which is common in many Indo-European languages, has always been interpreted in essentially semantic terms. A typical traditional formulation is

it is quite mistaken to transfer it to the earlier stages of Indo-European. In Greek, Old Irish, and Old Norse, for example, the historical present has quite different syntactic and semantic properties, to which the traditional idea, or any of its variants², must utterly fail to do justice.

* This work was supported in part by the Joint Services Electronics Program under Contract DA36-039-AMC-03200(E); in part by the National Science Foundation (Grant GP-2495), the National Institutes of Health (Grant MH-04737-05), the National Aeronautics and Space Administration (Grant NsG-496), and the U.S. Air Force (ESD Contract AF 19 (628)-2487). – I thank Michael Connolly, Eric Hamp, Einar Haugen, George Lakoff, Calvert Watkins, and Roy Wright for offering valuable criticism and/or referring me to some of the examples cited here.

The Turing Test



The Turing Test

Interrogator: In the first line of your sonnet which reads "Shall I compare thee to a summer's day," would not "a spring day" do as well or better?



The Turing Test

Interrogator: In the first line of your sonnet which reads "Shall I compare thee to a summer's day," would not "a spring day" do as well or better?



The Turing Test



Interrogator: In the first line of your sonnet which reads "Shall I compare thee to a summer's day," would not "a spring day" do as well or better?

Witness: It wouldn't scan.

The Turing Test



Interrogator: In the first line of your sonnet which reads "Shall I compare thee to a summer's day," would not "a spring day" do as well or better?

Witness: It wouldn't scan.

The Turing Test



Interrogator: In the first line of your sonnet which reads "Shall I compare thee to a summer's day," would not "a spring day" do as well or better?

Witness: It wouldn't scan.

Interrogator: How about "a winter's day," That would scan all right.

The Turing Test



Interrogator: In the first line of your sonnet which reads "Shall I compare thee to a summer's day," would not "a spring day" do as well or better?

Witness: It wouldn't scan.

Interrogator: How about "a winter's day," That would scan all right.

The Turing Test



Interrogator: In the first line of your sonnet which reads "Shall I compare thee to a summer's day," would not "a spring day" do as well or better?

Witness: It wouldn't scan.

Interrogator: How about "a winter's day," That would scan all right.

Witness: Yes, but nobody wants to be compared to a winter's day.

The Turing Test



Interrogator: In the first line of your sonnet which reads "Shall I compare thee to a summer's day," would not "a spring day" do as well or better?

Witness: It wouldn't scan.

Interrogator: How about "a winter's day," That would scan all right.

Witness: Yes, but nobody wants to be compared to a winter's day.

The Turing Test



Interrogator: In the first line of your sonnet which reads "Shall I compare thee to a summer's day," would not "a spring day" do as well or better?

Witness: It wouldn't scan.

Interrogator: How about "a winter's day," That would scan all right.

Witness: Yes, but nobody wants to be compared to a winter's day.

Interrogator: Would you say Mr. Pickwick reminded you of Christmas?

The Turing Test



Interrogator: In the first line of your sonnet which reads "Shall I compare thee to a summer's day," would not "a spring day" do as well or better?

Witness: It wouldn't scan.

Interrogator: How about "a winter's day," That would scan all right.

Witness: Yes, but nobody wants to be compared to a winter's day.

Interrogator: Would you say Mr. Pickwick reminded you of Christmas?

The Turing Test



Interrogator: In the first line of your sonnet which reads "Shall I compare thee to a summer's day," would not "a spring day" do as well or better?

Witness: It wouldn't scan.

Interrogator: How about "a winter's day," That would scan all right.

Witness: Yes, but nobody wants to be compared to a winter's day.

Interrogator: Would you say Mr. Pickwick reminded you of Christmas?

Witness: In a way.

The Turing Test



Interrogator: In the first line of your sonnet which reads "Shall I compare thee to a summer's day," would not "a spring day" do as well or better?

Witness: It wouldn't scan.

Interrogator: How about "a winter's day," That would scan all right.

Witness: Yes, but nobody wants to be compared to a winter's day.

Interrogator: Would you say Mr. Pickwick reminded you of Christmas?

Witness: In a way.

The Turing Test



Interrogator: In the first line of your sonnet which reads "Shall I compare thee to a summer's day," would not "a spring day" do as well or better?

Witness: It wouldn't scan.

Interrogator: How about "a winter's day," That would scan all right.

Witness: Yes, but nobody wants to be compared to a winter's day.

Interrogator: Would you say Mr. Pickwick reminded you of Christmas?

Witness: In a way.

Interrogator: Yet Christmas is a winter's day, and I do not think Mr. Pickwick would mind the comparison.

The Turing Test



Interrogator: In the first line of your sonnet which reads "Shall I compare thee to a summer's day," would not "a spring day" do as well or better?

Witness: It wouldn't scan.

Interrogator: How about "a winter's day," That would scan all right.

Witness: Yes, but nobody wants to be compared to a winter's day.

Interrogator: Would you say Mr. Pickwick reminded you of Christmas?

Witness: In a way.

Interrogator: Yet Christmas is a winter's day, and I do not think Mr. Pickwick would mind the comparison.

The Turing Test



Interrogator: In the first line of your sonnet which reads "Shall I compare thee to a summer's day," would not "a spring day" do as well or better?

Witness: It wouldn't scan.

Interrogator: How about "a winter's day," That would scan all right.

Witness: Yes, but nobody wants to be compared to a winter's day.

Interrogator: Would you say Mr. Pickwick reminded you of Christmas?

Witness: In a way.

Interrogator: Yet Christmas is a winter's day, and I do not think Mr. Pickwick would mind the comparison.

Witness: I don't think you're serious. By a winter's day one means a typical winter's day, rather than a special one like Christmas.

Noam Chomsky

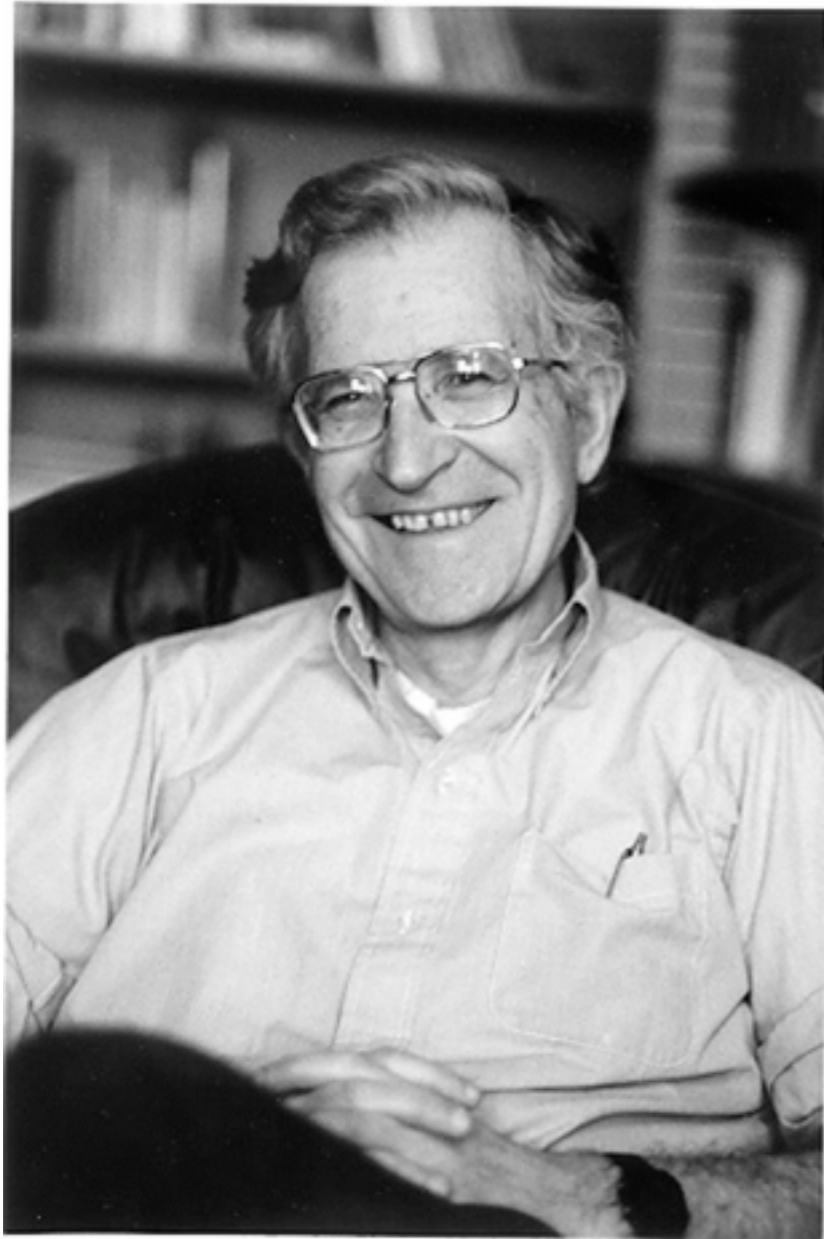

Noam Chomsky

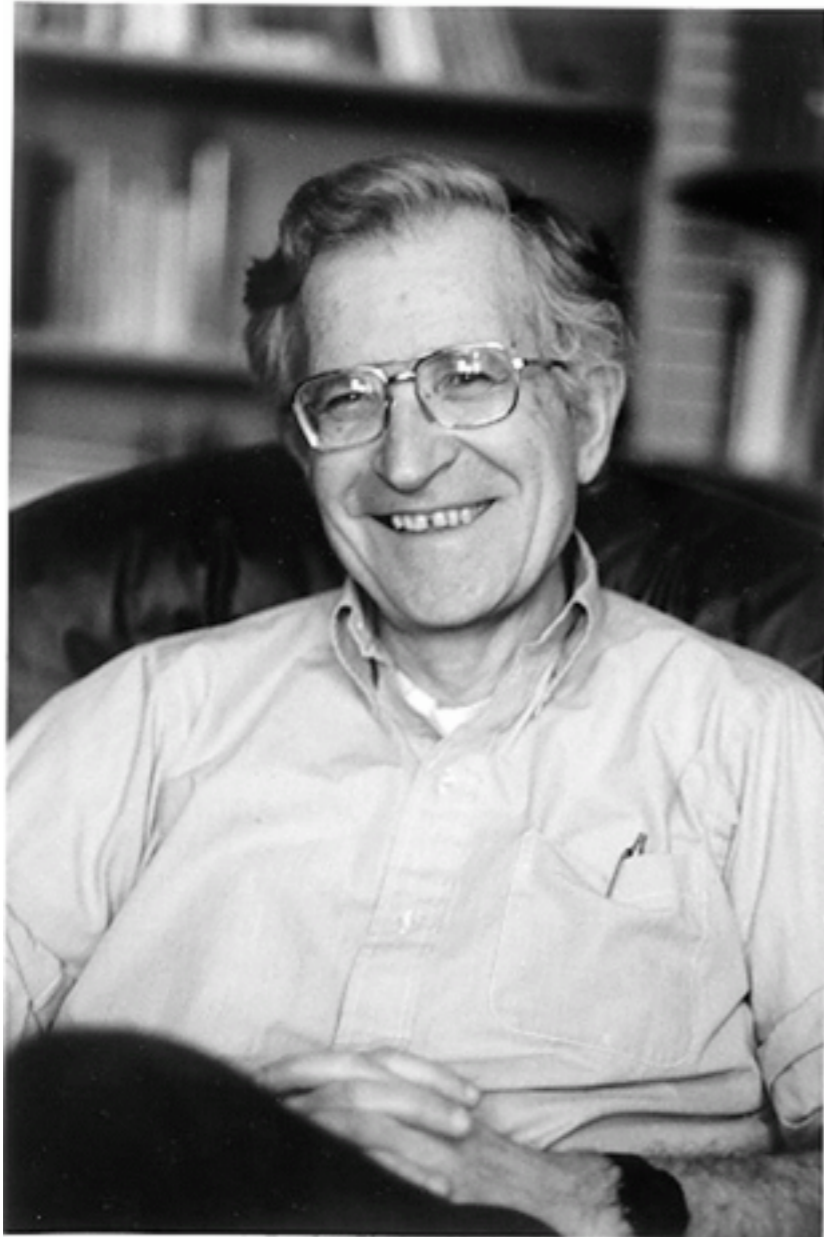

- Polemical anarcho-syndicalist

Noam Chomsky

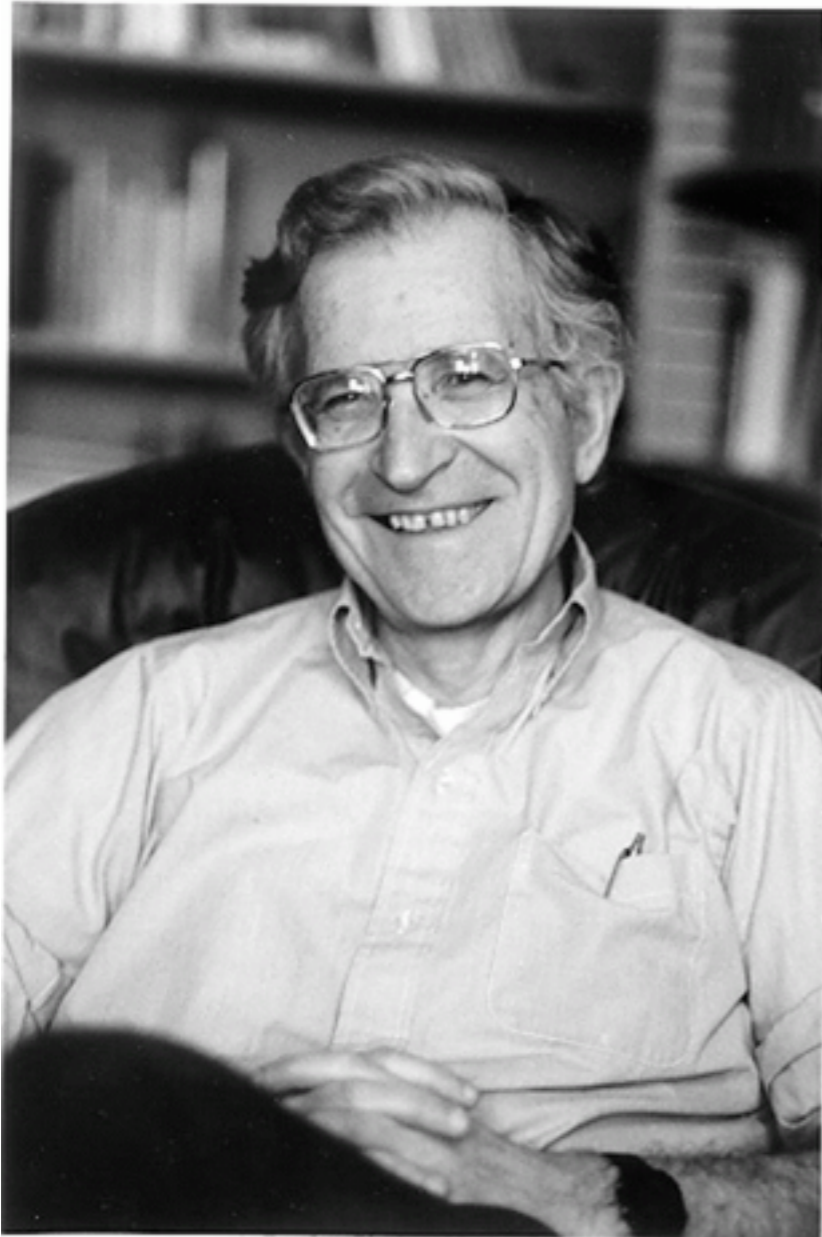

- Polemical anarcho-syndicalist
- Inventor of several theories of “generative grammar”

Noam Chomsky

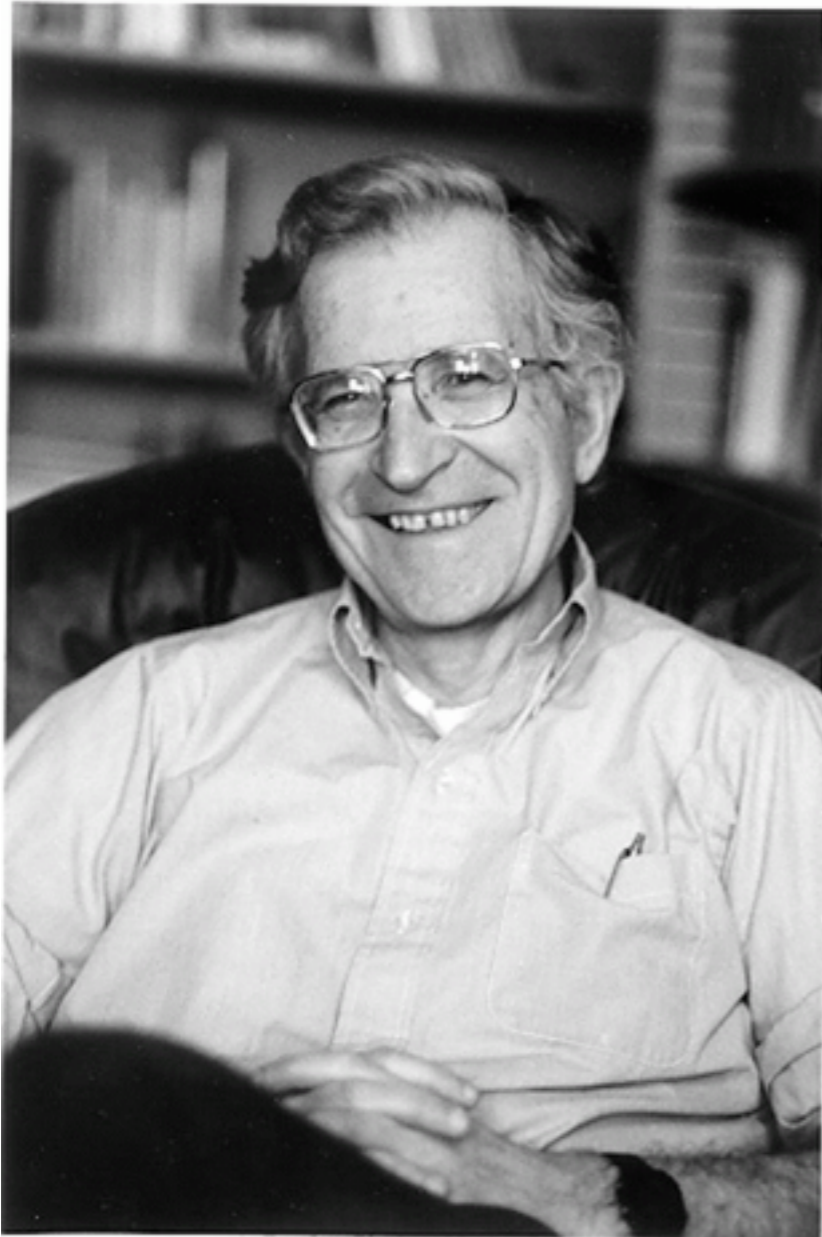

- Polemical anarcho-syndicalist
- Inventor of several theories of “generative grammar”
- Pioneer of formal language theory

Modularity

Linguistic Modules

- Phonetics and phonology
- Morphology
- Syntax
- Semantics
- Pragmatics
- Discourse
- *With lots of crossings between levels!*

Phonetics and Phonology

- Phonetics: language sounds & their physiology
- Phonology: systems of discrete sounds in languages
 - E.g.: devoicing of *it is* to *it's*
 - E.g.: syllable structure: *sign*, *signify*

Morphology

- Inflectional (in some languages):
 - *love → loved*
- Derivational:
 - *tea-cup, un-helpful, with-stand, craisin*
- Turkish: *uygarlastiramadiklarimizdanmissinizcasina*
 - *uygar las tir ama dik lar imiz dan mis siniz casina*
 - *(behaving) as if you are among those whom we could not civilize*

Morphological Tagging

There are many kinds of trench mortars.

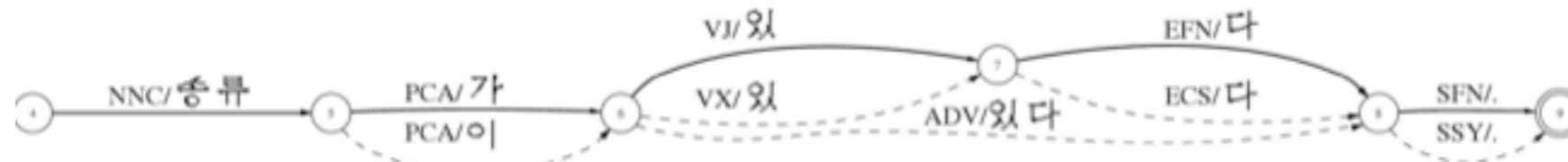

c. Klimatizovaná jídelna, světlá místnost pro snídani.

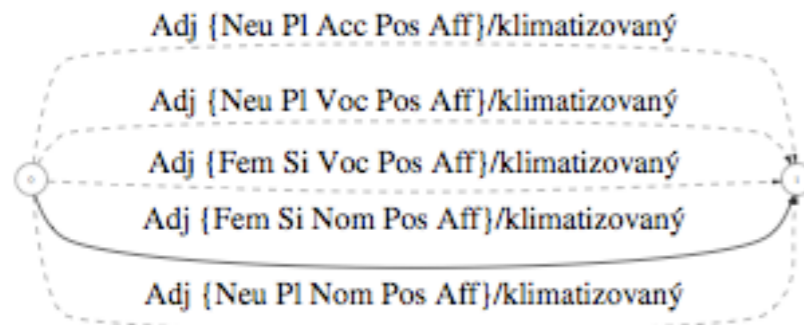

Noun {Fem Si Nom Aff}/jídelna

Punc/,

Air-conditioned dining room,

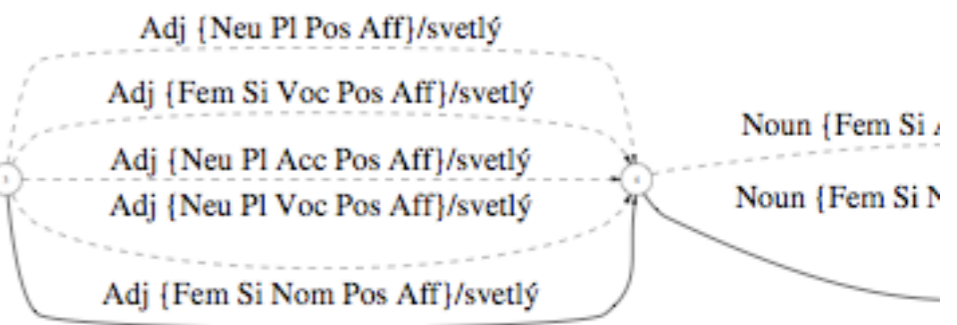

Syntax

Syntax

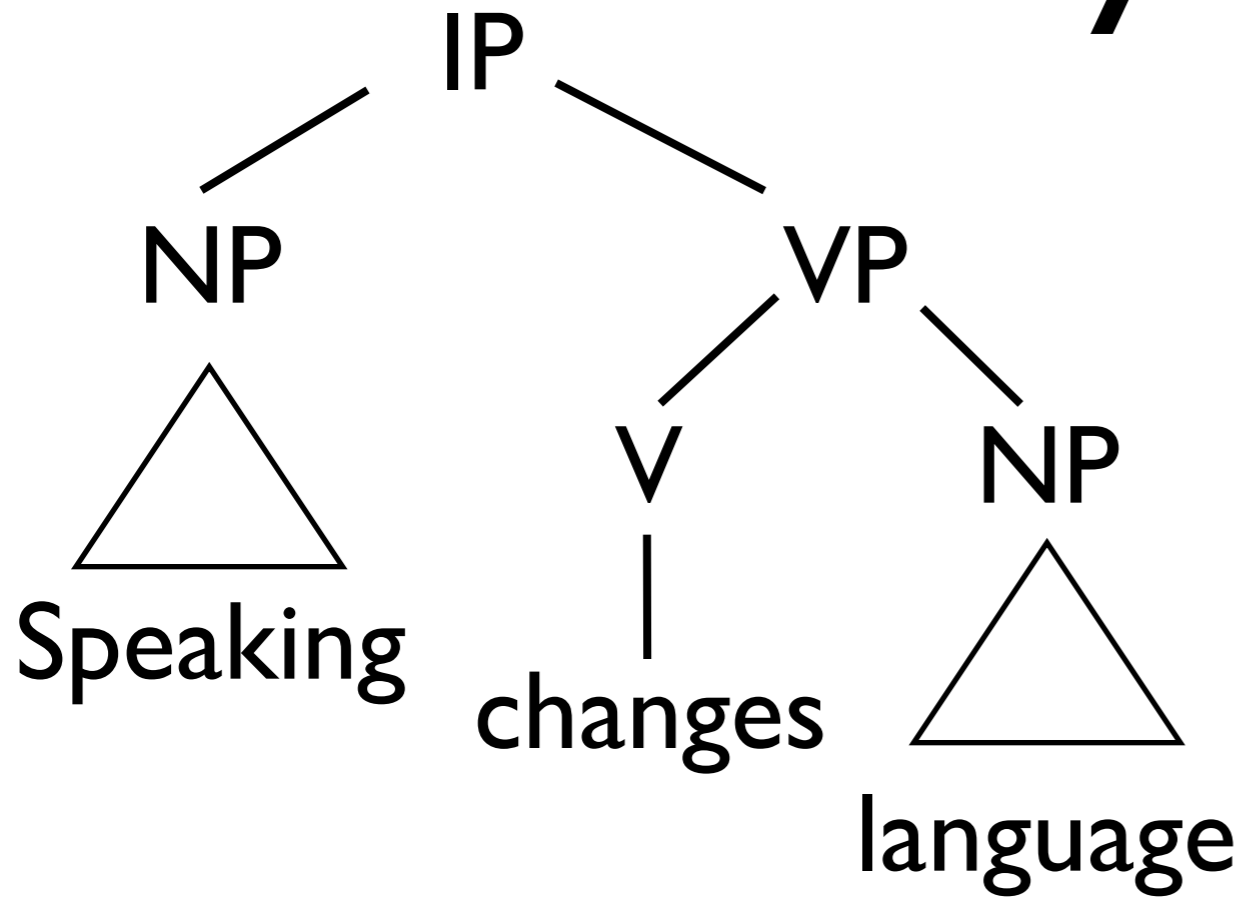

Constituency

Syntax

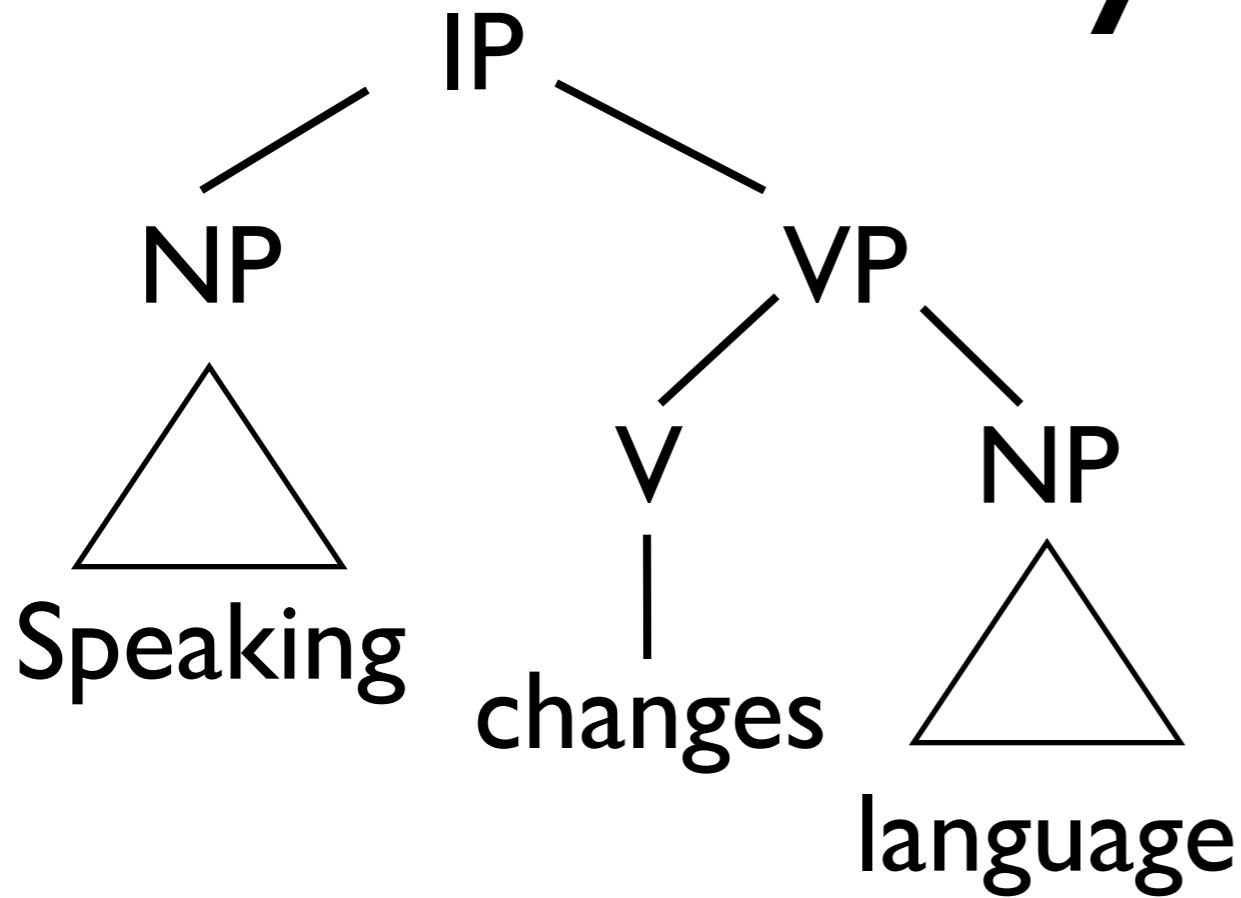

Constituency

Dependency

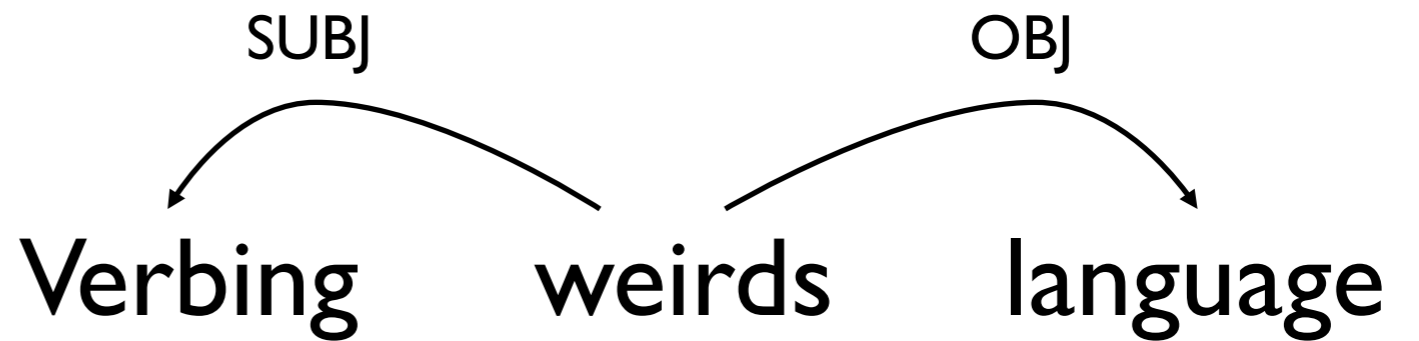

Semantics

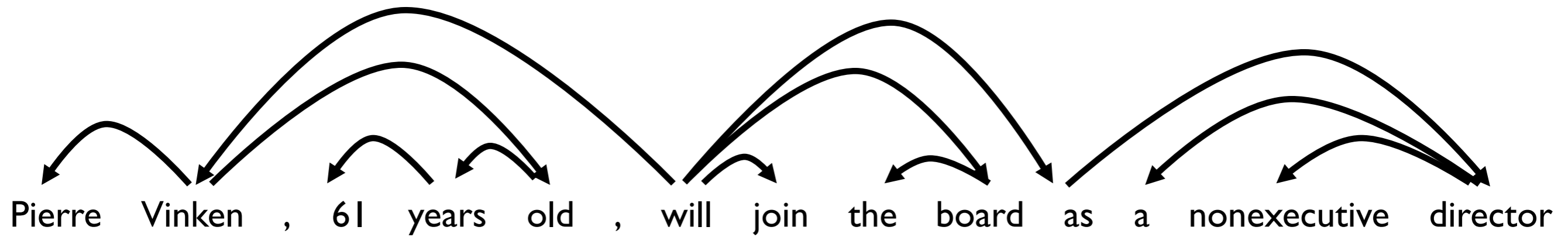

Semantics

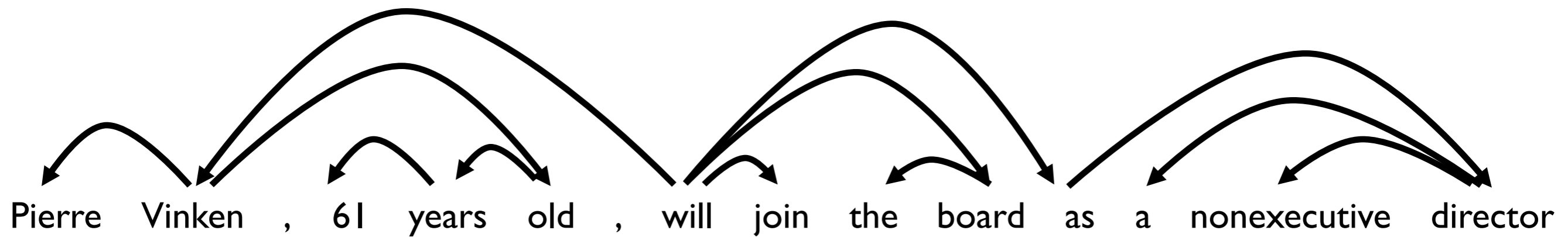

PropBank join predicate

ARG0	ARG1	ARG-PRD
Vinken	board	director

Pragmatics

- Context affects meaning
- Conversational implicature
 - *May I speak to your mother? Yes.*
- Speech acts: “how to do things with words”
 - *I grant you permission to speak.*

Discourse

- Study of units larger than a single utterance
 - Turn taking
 - Coreference
 - Organized exposition

It All Hangs Together

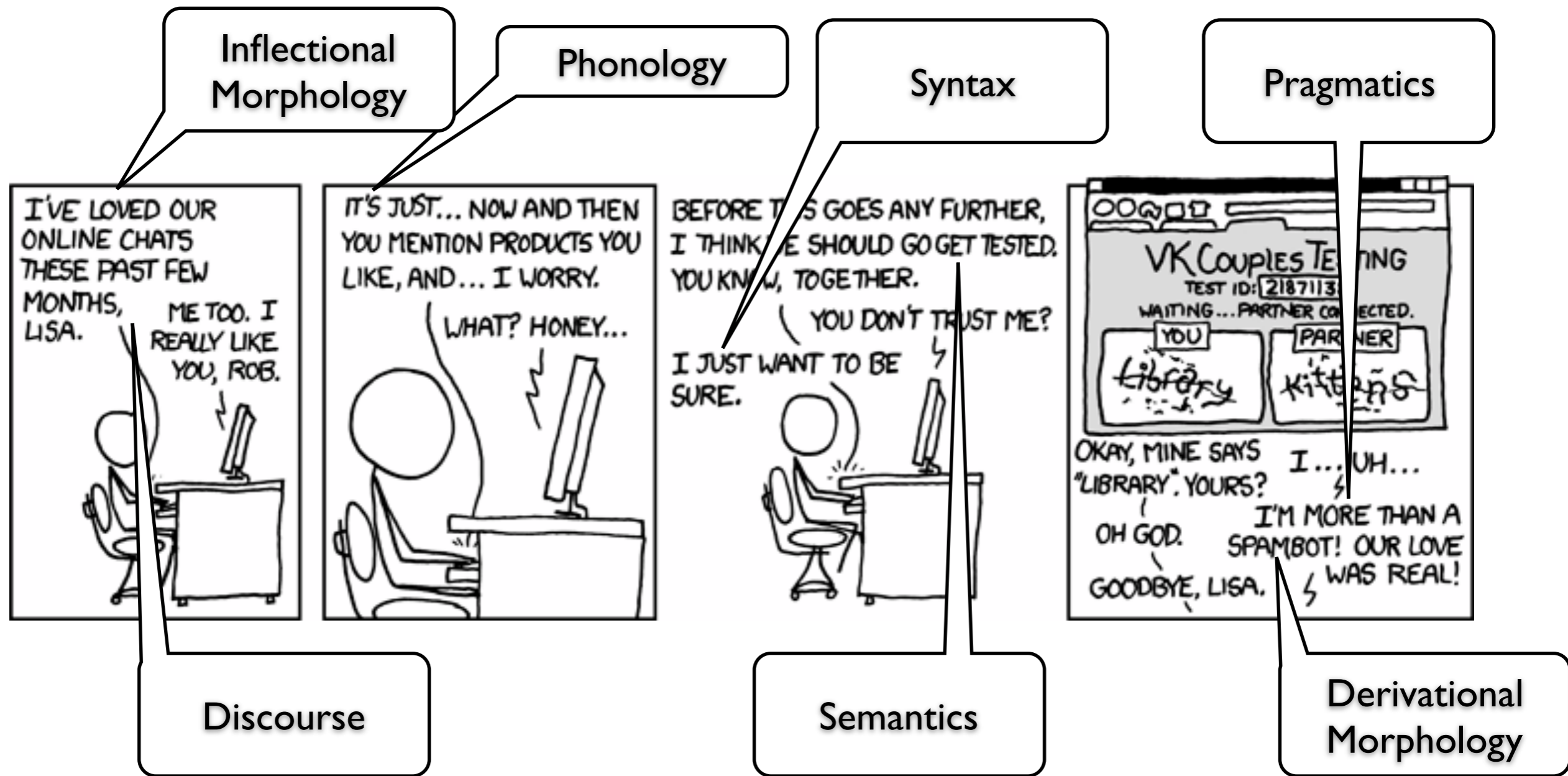

Applications

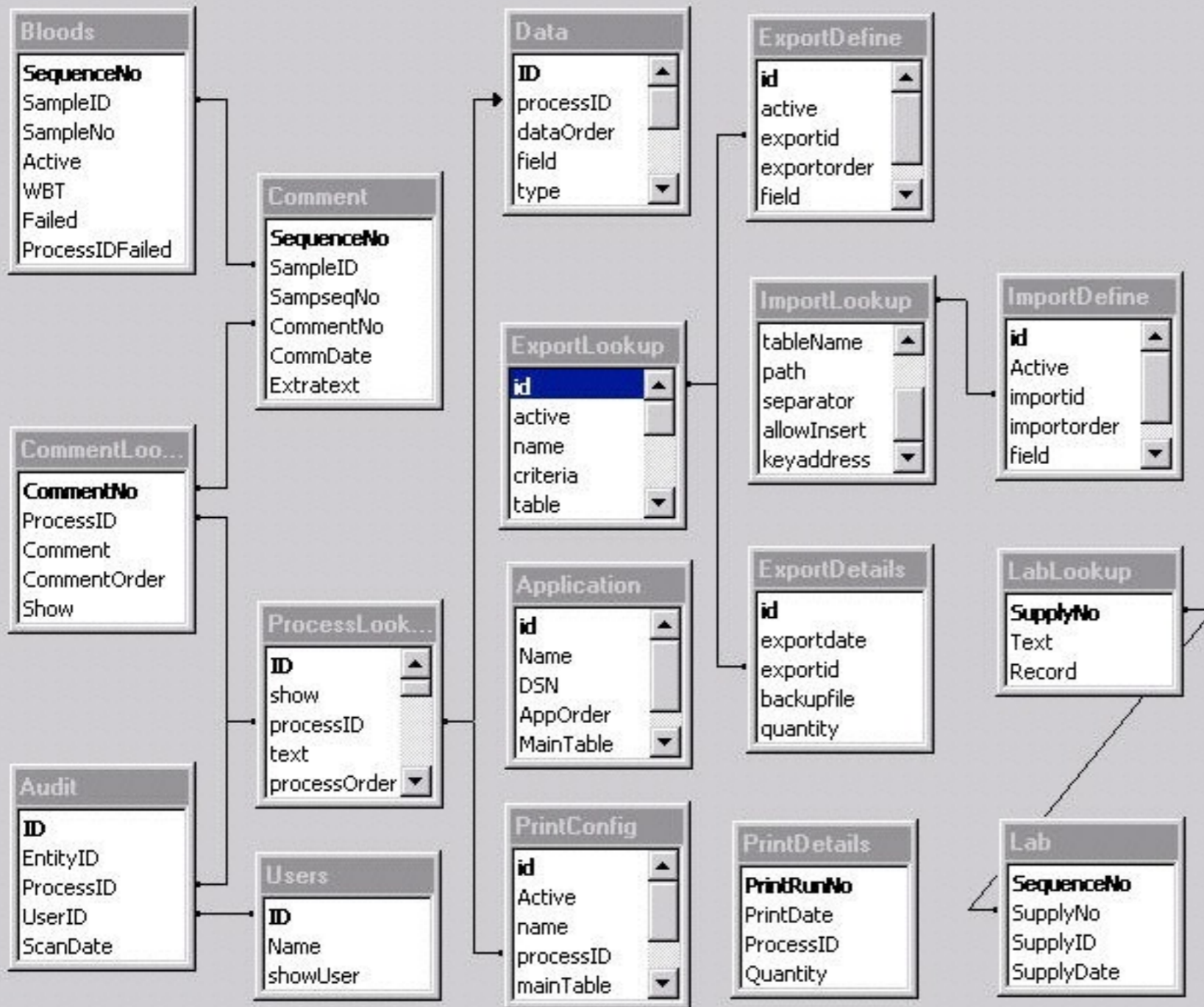

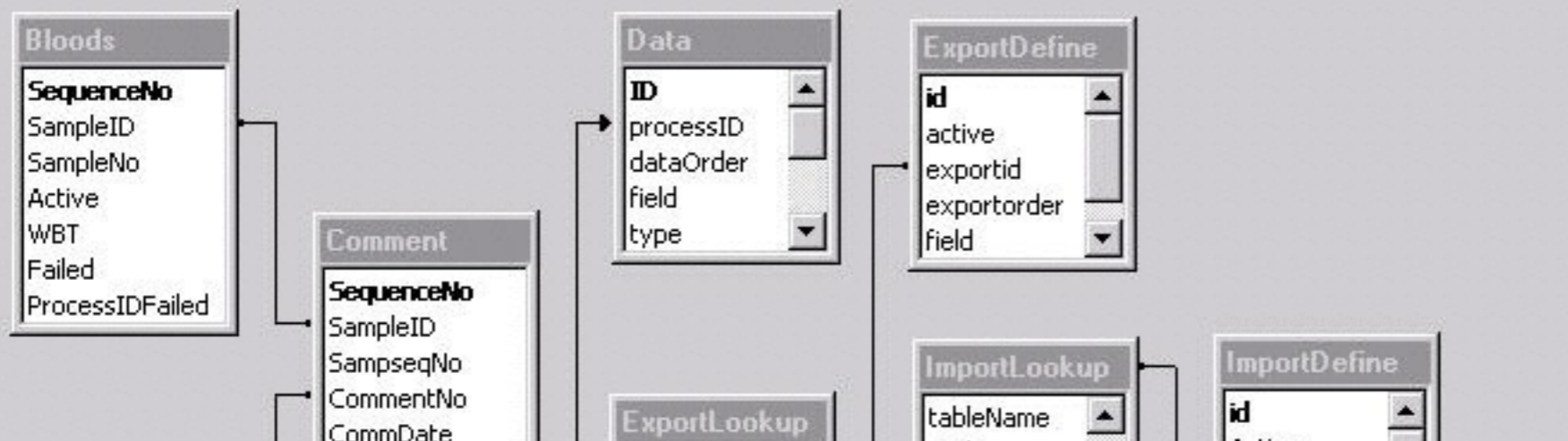

CommentL
CommentNo
ProcessID
Comment
CommentOr
Show

Audit
ID
EntityID
ProcessID
UserID
ScanDate

```

<bookstore>
<book category="COOKING">
  <title lang="en">Everyday Italian</title>
  <author>Giada De Laurentiis</author>
  <year>2005</year>
  <price>30.00</price>
</book>
<book category="CHILDREN">
  <title lang="en">Harry Potter</title>
  <author>J K. Rowling</author>
  <year>2005</year>
  <price>29.99</price>
</book>
<book category="WEB">
  <title lang="en">Learning XML</title>
  <author>Erik T. Ray</author>
  <year>2003</year>
  <price>39.95</price>
</book>
</bookstore>

```

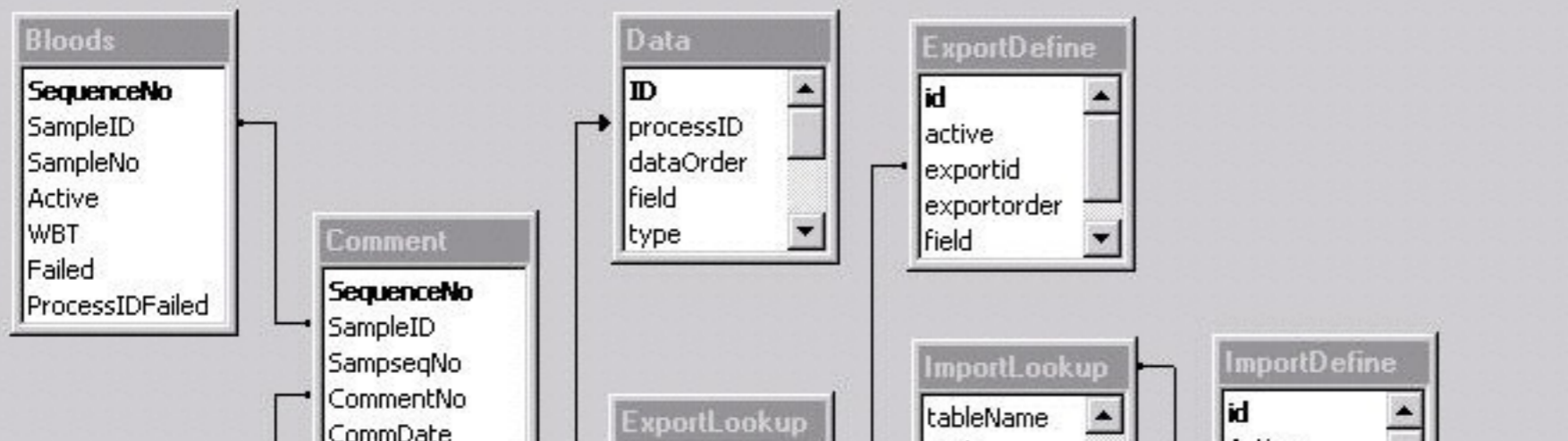



CommentL
CommentNo
 ProcessID
 Comment
 CommentOr
 Show

Audit
ID
 EntityID
 ProcessID
 UserID
 ScanDate

```

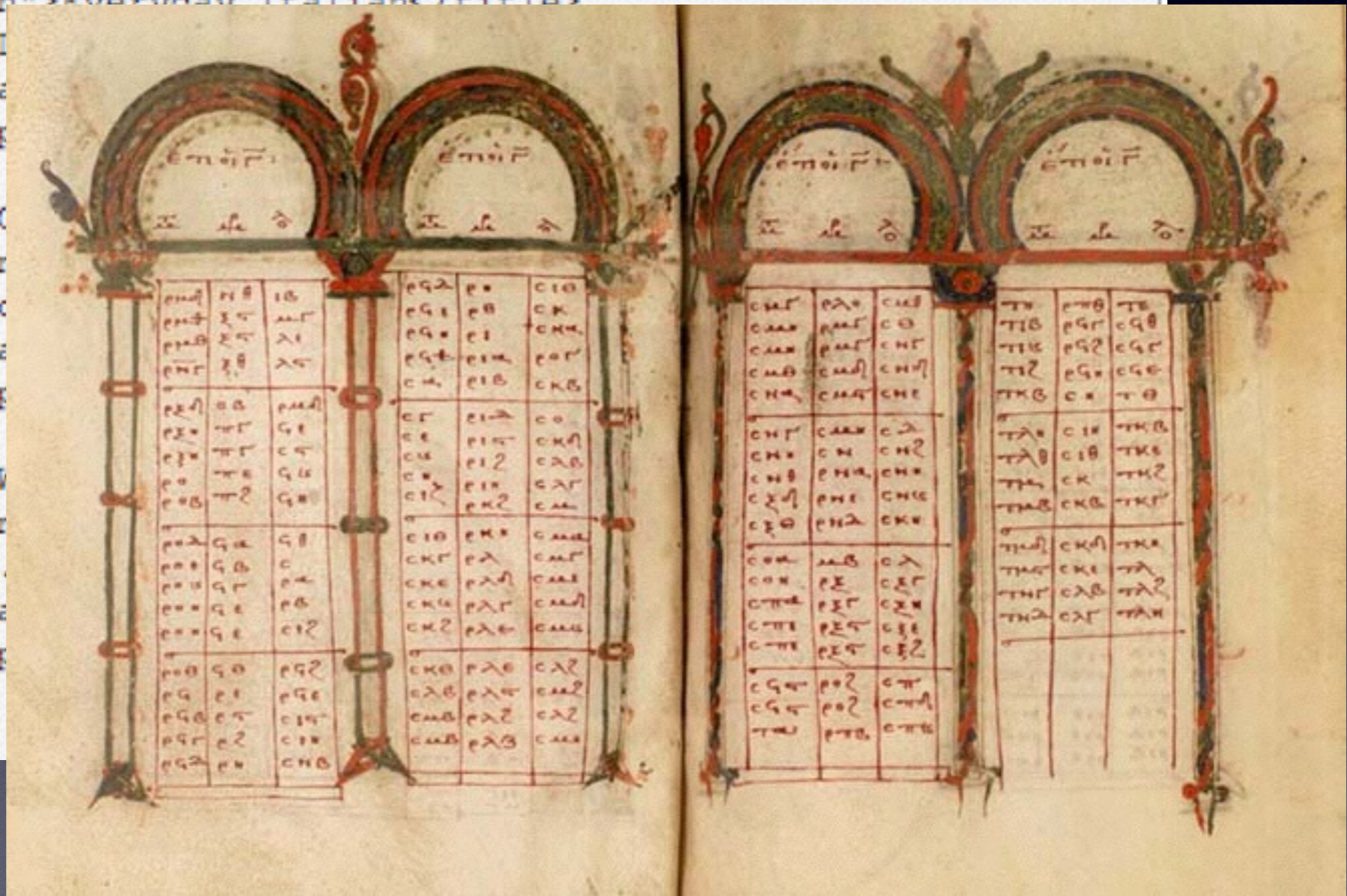
<bookstore>
<book category="COOKING">
  <title lang="en">Everyday Italian</title>
  <author>Giada De Laurentiis</author>
  <year>2005</year>
  <price>30.00</price>
</book>
<book category="COOKING">
  <title lang="en">The Way to Cook</title>
  <author>J. K. Ruhlman</author>
  <year>2005</year>
  <price>29.99</price>
</book>
<book category="WORLD">
  <title lang="en">The Way to Cook</title>
  <author>Erik T. Rasmussen</author>
  <year>2003</year>
  <price>39.95</price>
</book>
</bookstore>
  
```



16 Et hic quidem punctus, centrum circuli dicitur.
 17 Diameter circuli, est linea recta, quę super eius centrū transiens, extremitatesq; suas circūferētię applicās, circulū in duo media diuidit.
 18 Semicirculus, est figura plana diametro circuli, & medietate circūferētię cōtēta.
 19 Portio circuli, est figura plana, recta linea & parte circūferētię cōtēta, semicirculo quidē aut maior aut minor.

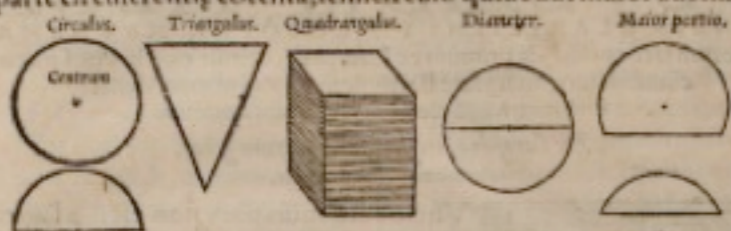

20 Rectilineę figurę sunt, quę rectis lineis continētur.
 21 Quarum quędā trilaterę, quę tribus rectis lineis: 22 Quędā quadrilaterę, quę quatuor rectis lineis: 23 Quędā multilaterę, quę pluribus q; quatuor rectis lineis continēnt.

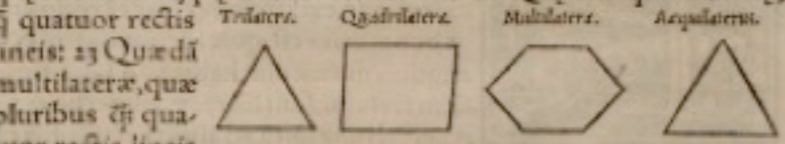

24 Figurarū trilaterarū, alia est triāgulus, habēs tria latera æqualia: 25 Alia triangulus, duo habēs æqualia latera: 26 Alia triangulus triū inæqualiū laterū.
 27 Harū iterū alia est orthogoniū, unū scilicet rectū angulū habēs.
 28 Alia est amblygoniū, aliquē obtusum angulū habens.
 29 Alia est oxygoniū, in qua tres anguli sunt acuti.

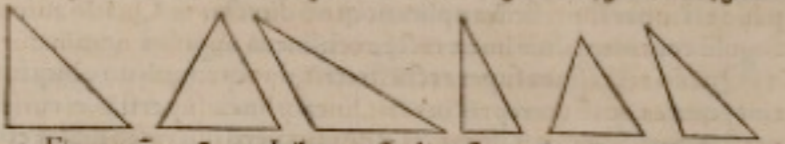

30 Figurarū autē quadrilaterarū, alia est quadratū, quod est æquilaterū rectāguli: 31 Alia est tetragonus lōgus, quę est figura rectāgula, sed æquilatera nō est: 32 Alia est helmuayn, quę est æquilatera, sed rectāgula nō est: 33 Alia est similis helmuayn, quę opposita latera

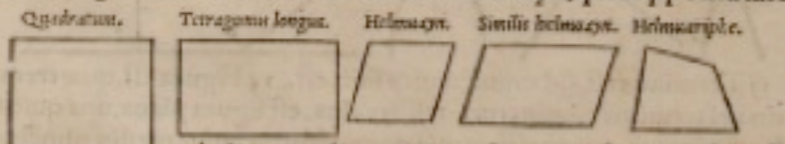

ra habet æqualia atq; oppositos angulos æquales, idē tamen nec rectis angulis nec æquis laterib; cōtinetur.

funt æquales. 16 Et hic quidem punctus, centrum circuli dicitur.
 17 Diameter circuli, est linea recta, quæ super eius centrū transiens,
 extremitatesq; suas circūferentiæ applicās, circulū in duo media diuisi-
 dit. 18 Semicirculus, est figura plana diametro circuli, & medietate
 circūferentiæ contēta. 19 Portio circuli, est figura plana, recta linea &
 parte circūferentiæ cōtēta, semicirculo quidē aut maior aut minor.

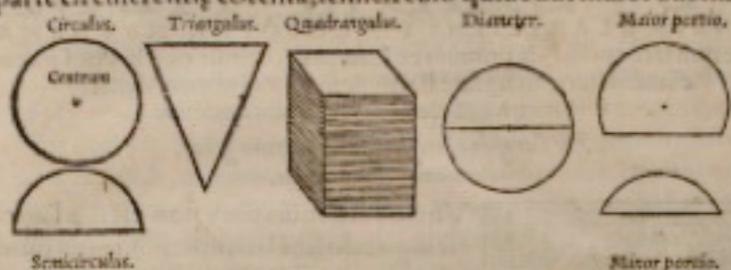

20 Rectilineæ figuræ sunt, quæ rectis lineis continētur. 21 Quarum
 quedā trilateræ, quæ tribus rectis lineis: 22 Quedam quadrilateræ,
 q̄ quatuor rectis lineis: 23 Quedā
 multilateræ, quæ
 pluribus q̄ qua-
 tuor rectis lineis
 cōtinent. 24 Figurarū trilaterarū, alia est triāgulus, habēs tria latera
 æqualia: 25 Alia triangulus, duo habēs æqualia latera: 26 Alia trian-
 gulus triū inæqualiū laterū. 27 Harū iterū alia est orthogoniū, unū
 scilicet rectū angulū habēs. 28 Alia est amblygoniū, aliquē obtusum
 angulū habens. 29 Alia est oxygoniū, in qua tres anguli sunt acuti.
 Dū æqualia latera. Triū inæqualiū laterū. Orthogoniū. Oxygoniū. Amblygoniū.

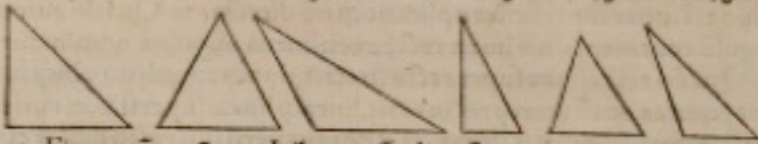

30 Figurarū autē quadrilaterarū, alia est quadratū, quod est æqui-
 laterū rectāgulū: 31 Alia est tetragonus lōgus, quæ est figura rectan-
 gula, sed æquilatera nō est: 32 Alia est helmuayn, quæ est æquilatera,
 sed rectāgula nō est: 33 Alia est similis helmuayn, quæ opposita late-

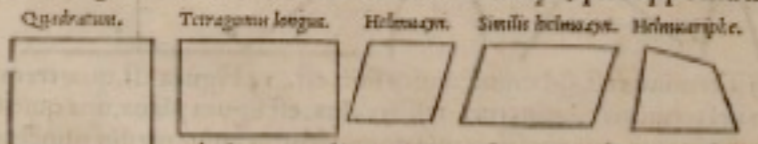

ra habet æqualia atq; oppositos angulos æquales, idē
 tamen nec rectis angulis nec æquis laterib. cōtinetur.

paper.pdf (9 pages)

7 Page Back/Forward Zoom In Zoom Out

Baselines	Dependency accuracy [%]			
	German		Spanish	
Modify prev.	18.2		28.5	
Modify next	27.5		21.4	
Training sentences	1k	10k	1k	10k
EM	30.2	30.8	25.6	24.9
Hard proj.	66.2	64.8	59.1	60.1
Hard proj. w/EM	58.6	59.8	53.0	52.8
QG w/EM	68.5	66.9	64.8	64.8

Table 2: Unlabeled dependency accuracy for German and Spanish with different training conditions and training set sizes.

5.2 Unsupervised Learning

5.4 QG Projection

to find sentences where enough links were projected to completely determine a target language tree. Of course, we needed to filter more than 1000 sentences of bixtext to output 1000 training sentences in this way. With this subset, we can simply perform supervised training. As discussed in §2, these links are still quite noisy. Performance in fact suffers when we add more of this noisy training data. Still, this method is a substantial improvement over the baselines and unsupervised EM.

Instead of finding fully projected trees, we can simply take the one-to-one projected links are given, impute expected counts for the remaining structures with EM, and update our models. This approach ("hard projection with EM"), however, performed worse than using only the fully projected trees. In fact, only the first iteration of EM with this method made any improvement. Afterwards, EM degraded accuracy further from the numbers in table 2.

[Delete all spam messages now](#) (messages that have been in Spam more than 30 days will be automatically deleted)

Roland R. Duncan	Show your love to your special people! - EMAIL ID: ReJjr
=?UNKNOWN?B??=]	[JHSPAM-ALERT-IP] Piranesi 4 =?UNKNOWN?B?s8y3c6qpLW03Tw==?= - zT381OoDMFP3 Adobe Pt
Doctor Jeanne Holt	[JHSPAM-ALERT-IP] Something interesting for you - XMAILOE %XMIMEOE You can make your girl-frie
peggy.ruby	[JHSPAM-ALERT-IP]
Janie Adkins	[JHSPAM-ALERT-IP] Ficken wie ein Weltmeister ? - Meinung von unserem Kunden: Ich glaube, ich hab
Cary Phelps	No Hassle Business Loans - If you have your own business and need IMMEDIATE money to spend ANY \
Elias Moran	[JHSPAM-ALERT-IP] Loans - Small Business - If you have your own business and require IMMEDIATE c
Dr John Avery	[JHSPAM-ALERT-IP] Something interesting for you - XMAILOE %XMIMEOE X-Antivirus: avast! (VPS 08
Roland Reid	Business Loans - If you have your own business and need IMMEDIATE ready money to spend ANY way y
Doctor Max Stokes	[JHSPAM-ALERT-IP] It's important for you - XMAILOE %XMIMEOE Make your lady-love contented! You
¶W±j r«¬ μ∅±d□Ñ°Đ□»!X□@».	[JHSPAM-ALERT-IP] =?UNKNOWN?B?qr6mV6q6qL6scrNuxektUnFU?= - oOUQs3Xk Adobe After Effe



WIKIPEDIA
The Free Encyclopedia

navigation

- Main Page
- Contents
- Featured content
- Current events
- Random article

interaction

- About Wikipedia
- Community portal
- Recent changes
- Contact Wikipedia
- Donate to Wikipedia
- Help

article discussion edit this page history

Parsing

From Wikipedia, the free encyclopedia

For the computer programming language, see [Parser \(CGI language\)](#).

In [computer science](#) and [linguistics](#), **parsing** (more formally: *syntactic analysis*) respect to a given [formal grammar](#). A **parser** is the component of a [compiler](#) that

Parsing transforms input text into a data structure, usually a tree, which is suitable for creating tokens from a sequence of input characters and it is these tokens that are used for further processing.

Parsing is also an earlier term for the diagramming of sentences of natural languages or Latin.

Parser generators are tools that can automatically generate a parser (in some cases a compiler compiler).

Parsers can also be constructed as executable specifications of grammars in functional programming languages or others to construct a set of [higher-order functions](#) (called [parser combinators](#)) which can be used as executable specifications of ambiguous grammars containing left-recursive productions.

Contents [hide]

- Human languages

 [dreamyshade](#) : linguistics professor mentions "caps lock is cruise control for cool" and i giggled uncontrollably while everybody else is like "huh?" ☺ (2008-01-28 19:51:54)

 [djilbaman](#) : @[empoor](#) Well, I'm looking for a uni that specialises in both media and linguistics ☺ (2008-01-28 11:49:53)

 [andypowe11](#) : Note: e-learning symposium from the Subject Centre for Languages, Linguistics and Area Studies now being streamed live - <http://tinyurl.com/andypowe11>. ... ☺ (2008-01-25 05:44:26)

 [etoile](#) : is it wrong that I find my linguistics teacher to be lookin' kinda hot today? ☺ (2008-01-24 15:08:08)

 [makimoto](#) : いかん。CLちゃんが頭から離れない。いったいどなんだろう？(勿論、CLとは Computational Linguistics の略です) ☺ (2008-01-24 08:40:54)

 [dreamyshade](#) : in class today, my linguistics professor discussed lolcats which are watching you fap ☺ (2008-01-23 21:00:09)

 [evantheus](#) : Preparing for another crop of Baby linguistics... THIS. IS. LINGUISTICS. I mean... THIS. IS. SPARTAAAAA. (don't beat me teacher) ☺ (2008-01-23 11:40:09)

 [laurak](#) : @[FrF_Kmeron](#) - Did I also forget to mention that I was a Linguistics major in college ☺ (2008-01-23 08:18:25)

Would you like to...



[Add to calendar](#)

Feature space Maximu...
Fri Feb 8 12pm – Fri F...

Would you like to...

Dar al hayat ENGLISH PDF الحياة الطبعة السعودية دار الحياة

المشرق المشرق المشرق المشرق المشرق المشرق المشرق المشرق المشرق المشرق

الادعاء يطلب أقصى عقوبة لثلاثة متهمين بالتخطيط لاغتيال بوش
عمان الحياة - //07/02/08

ابحث

على ثلاثة متهمين بالتخطيط لاغتيال
نمبر (2006، بعدما وجه التهم

دار الحياة

Google™

machine translation

Search

[Advanced Search](#)
[Preferences](#)

Web

Results 1 - 10 of about 2,790,000 for machine translation [definition]. (0.15 seconds)

[Machine translation - Wikipedia, the free encyclopedia](#)

Machine translation, sometimes referred to by the acronym **MT**, is a sub-field of computational linguistics that investigates the use of computer software to ...

en.wikipedia.org/wiki/Machine_translation - 56k - [Cached](#) - [Similar pages](#) - [Note this](#)

[Free Online Translator](#)

Free Online Language **Translation**. Translates from English, Chinese Simplified, Chinese Traditional, Dutch, French, German, Greek, Italian, Japanese, Korean, ...

www.worldlingo.com/products_services/worldlingo_translator.html - 12k - [Cached](#) - [Similar pages](#) - [Note this](#)

[Machine Translation Engine](#)

TranslateNow! Access 20 on-line **machine translation** systems from a single screen. Have various online **machine translation** systems translate your texts ...

www.foreignword.com/Tools/transnow.htm - 3k - [Cached](#) - [Similar pages](#) - [Note this](#)

[machine translation](#)

www.springerlink.com/openurl.asp?genre=journal&issn=0922-6567 - [Similar pages](#) - [Note this](#)

Sponsored Links

[Machine Translation](#)

Google is looking for Engineering experts to join our team. Apply!
www.google.com/jobs

[Language Weaver](#)

High quality, statistically-based **translation** software.
www.languageweaver.com

[Translation Software](#)

Spanish, French, German, Japanese, Chinese, Korean, Polish, Russian.
www.allvirtualware.com

[Free Translation Software](#)

Download your free trial of SYSTRAN

Translation

Translation

Er wird in den Strassen wandern

Translation

Er wird in den Strassen wandern

He will in the streets walk

Translation

Er wird in den Strassen wandern

He will in the streets walk

He will walk in the streets



Translation

Er wird in den Strassen wandern

He will in the streets walk

He will walk in the streets



Er wird in den **kleinen** Strassen wandern

Translation

Er wird in den Strassen wandern

He will in the streets walk

He will walk in the streets



Er wird in den **kleinen** Strassen wandern

He will in the small streets walk

Translation

Er wird in den Strassen wandern

He will in the streets walk

He will walk in the streets



Er wird in den **kleinen** Strassen wandern

He will in the small streets walk

He is in the small streets hike



Translation



Er wird in den Strassen wandern

He will in the streets walk

He will walk in the streets



Er wird in den **kleinen** Strassen wandern

He will in the small streets walk

He is in the small streets hike



Question Answering

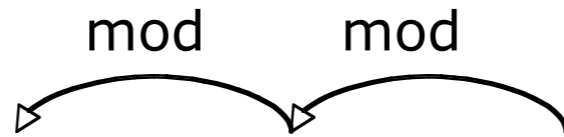

Who is the leader of France ?

Question Answering

Who is the leader of France ?



The diagram shows two curved arrows labeled 'mod' above the words 'leader' and 'France' in the question. The first arrow points from 'leader' to 'France', and the second arrow points from 'France' to 'leader'.

Henri Hadjenberb , who is the leader of France 's Jewish community

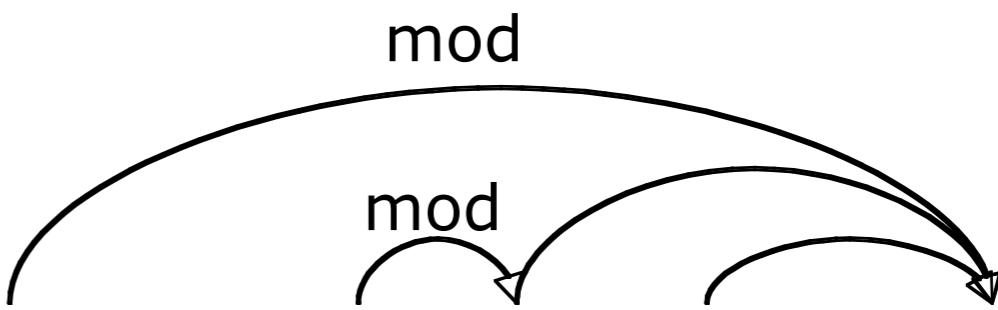

The diagram shows three curved arrows labeled 'mod' above the words 'leader', 'France', and 'Jewish community' in the answer. The first arrow points from 'leader' to 'France', the second from 'France' to 'Jewish community', and the third from 'leader' to 'Jewish community'.

Question Answering

Who is the leader of France ?

The diagram shows two curved arrows labeled 'mod' above the words 'leader' and 'France'. The first arrow starts under 'leader' and points to 'France'. The second arrow starts under 'France' and points to 'leader'.

Henri Hadjenberb , who is the leader of France 's Jewish community

The diagram shows three curved arrows labeled 'mod' above the words 'leader of France' and 'Jewish community'. The first arrow starts under 'leader of France' and points to 'Jewish community'. The second arrow starts under 'France' and points to 'Jewish community'. The third arrow starts under 'Jewish community' and points to 'leader of France'.

Bush met with French president Jacques Chirac

The diagram shows one curved arrow labeled 'mod' above the words 'French president' and 'Jacques Chirac'. The arrow starts under 'French president' and points to 'Jacques Chirac'.

Multilingual “Topics” European Parliament Corpus

DA børn familie udnyttelse børns børnene seksuel
DE kinder kindern familie ausbeutung familien eltern
EL παιδιά παιδιών οικογένεια οικογένειας γονείς παιδικής
EN **children family child sexual families exploitation**
ES niños familia hijos sexual infantil menores
FI lasten lapsia lapset perheen lapsen lapsiin
FR enfants famille enfant parents exploitation familles
IT bambini famiglia figli minori sessuale sfruttamento
NL kinderen kind gezin seksuele ouders familie
PT crianças família filhos sexual criança infantil
SV barn barnen familjen sexuellt familj utnyttjande

DA mål nå målsætninger målet målsætning opnå
DE ziel ziele erreichen zielen erreicht zielsetzungen
EL στόχους στόχο στόχος στόχων στόχοι επίτευξη
EN **objective objectives achieve aim ambitious set**
ES objetivo objetivos alcanzar conseguir lograr estos
FI tavoite tavoitteet tavoitteena tavoitteiden tavoitteita tavoitteen
FR objectif objectifs atteindre but cet ambitieux
IT obiettivo obiettivi raggiungere degli scopo quello
NL doelstellingen doel doelstelling bereiken bereikt doelen
PT objetivo objetivos alcançar atingir ambicioso conseguir
SV mål målet uppnå målen målsättningar målsättning

DA andre anden side ene andet øvrige
DE anderen andere einen wie andererseits anderer
EL άλλες άλλα άλλη άλλων άλλους όπως
EN **other one hand others another there**
ES otros otras otro otra parte demás
FI muiden toisaalta muita muut muihin muun
FR autres autre part côté ailleurs même
IT altri altre altro altra dall parte
NL andere anderzijds anderen ander als kant
PT outros outras outro lado outra noutros
SV andra sidan å annat ena annan

Multilingual “Topics” Wikipedia comparable articles

CY sbaen madrid el la josé sbaeneg
DE de spanischer spanischen spanien madrid la
EL ισπανίας ισπανία de ισπανός ντε μαδρίτη
EN **de spanish spain la madrid y**
FA اسپانيا اسپانيايي کوبا مادريد
FI espanja de espanjan madrid la real
FR espagnol espagne madrid espagnole juan y
HE ספרד ספרדית דה מדריד הספרדית קובה
IT de spagna spagnolo spagnola madrid el
PL de hiszpański hiszpanii la juan y
RU де мадрид испании испания испанский de
TR ispanya ispanyol madrid la küba real

CY bardd gerddi iaith beirdd fardd gymraeg
DE dichter schriftsteller literatur gedichte gedicht werk
EL ποιητής ποίηση ποιητή έργο ποιητές ποιήματα
EN **poet poetry literature literary poems poem**
FA شاعر شعر ادبيات فارسی ادبی آثار
FI runoilija kirjailija kirjallisuuden kirjoitti runo julkaisi
FR poète écrivain littérature poésie littéraire ses
HE משורר ספרות שירה סופר שירים המשורר
IT poeta letteratura poesia opere versi poema
PL poeta literatury poezji pisarz in jego
RU поэт его писатель литературы поэзии драматург
TR şair edebiyat şiir yazar edebiyatı adlı

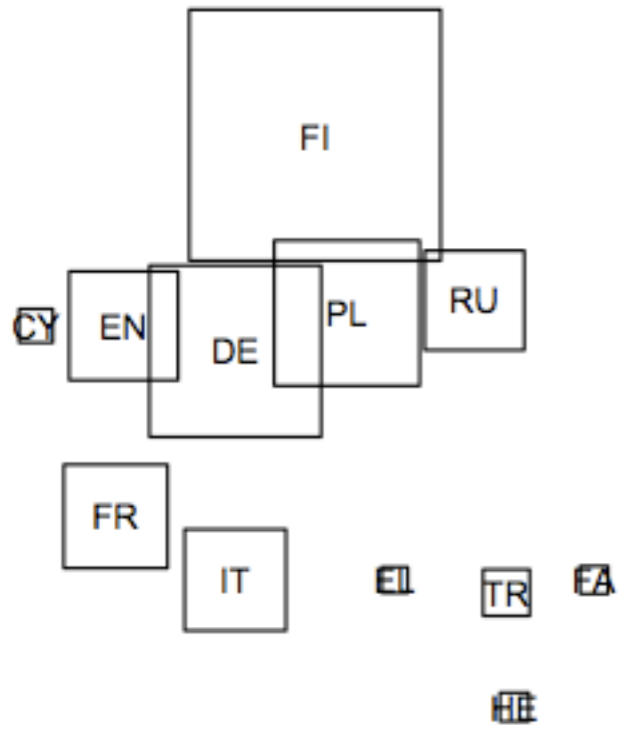

world ski km won

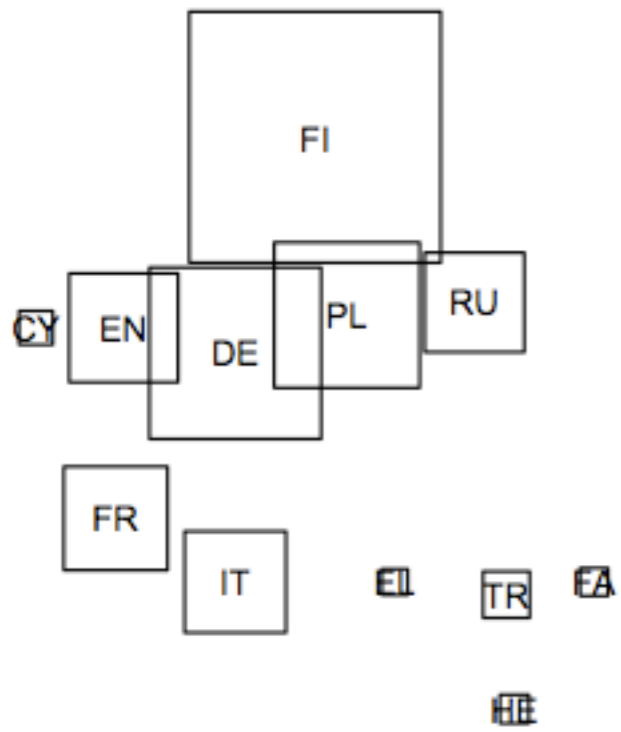

world ski km won

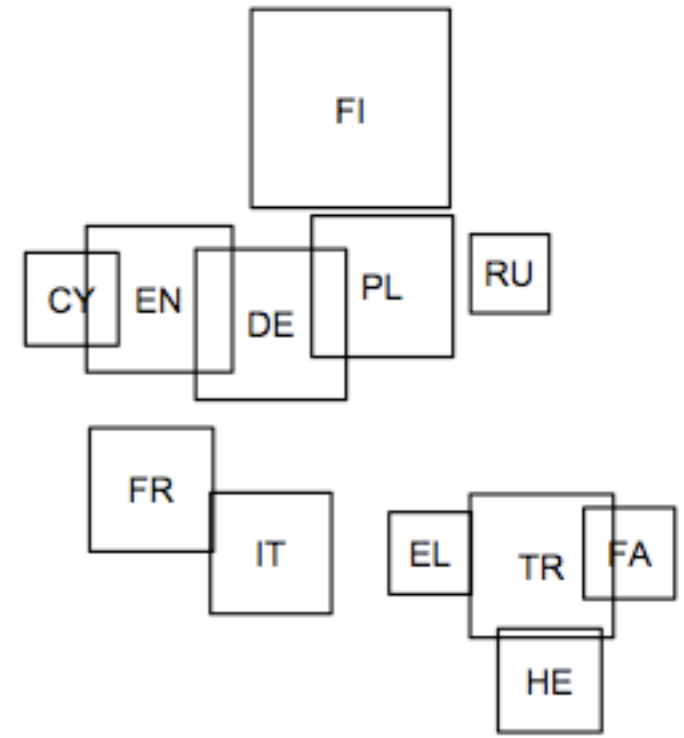

actor role television actress

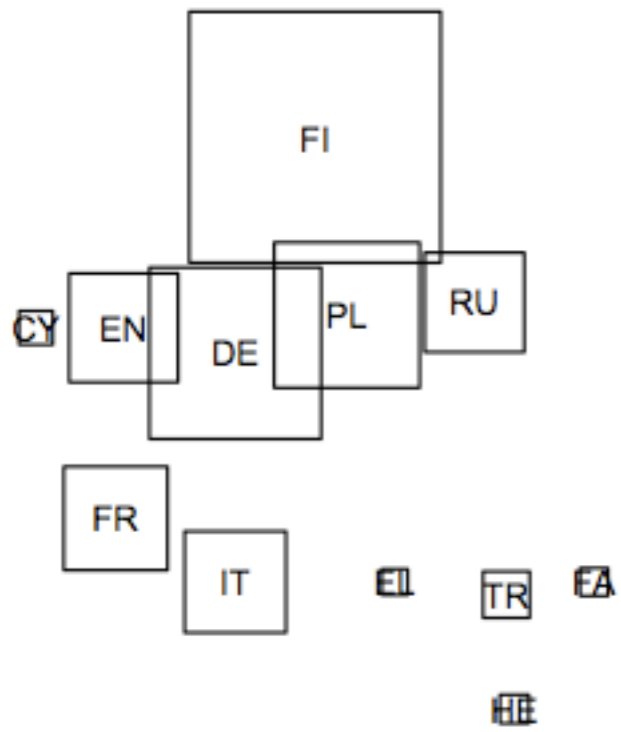

world ski km won

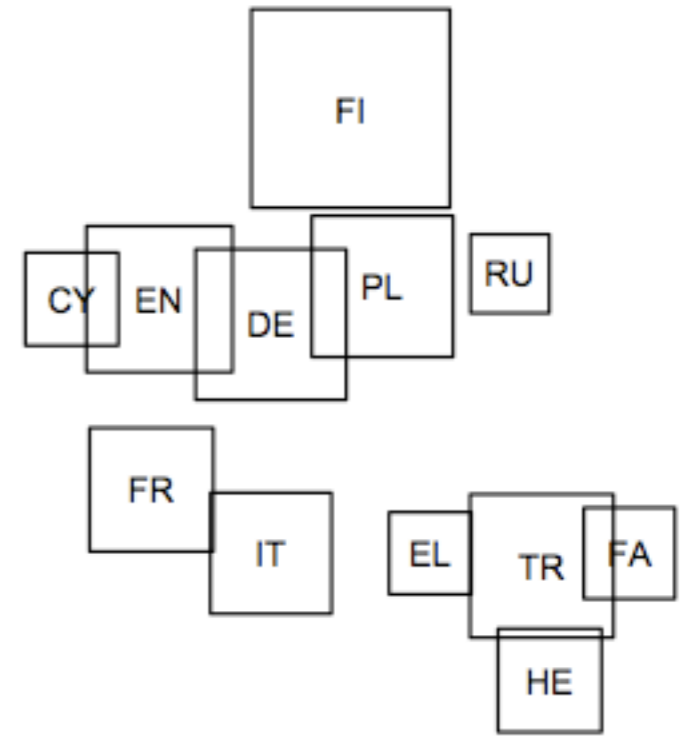

actor role television actress

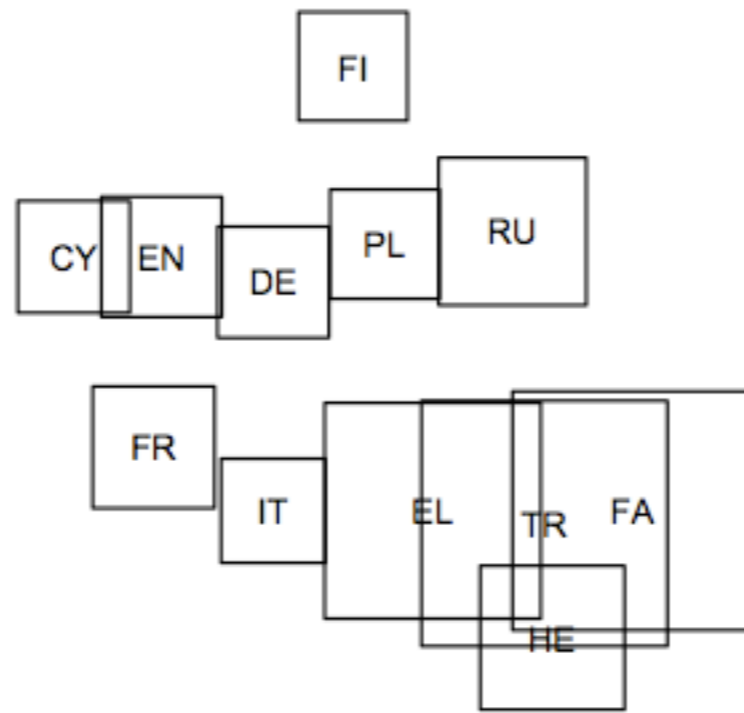

ottoman empire khan byzantine

Projecting Hidden Structure

Annotations From Existing English Tools

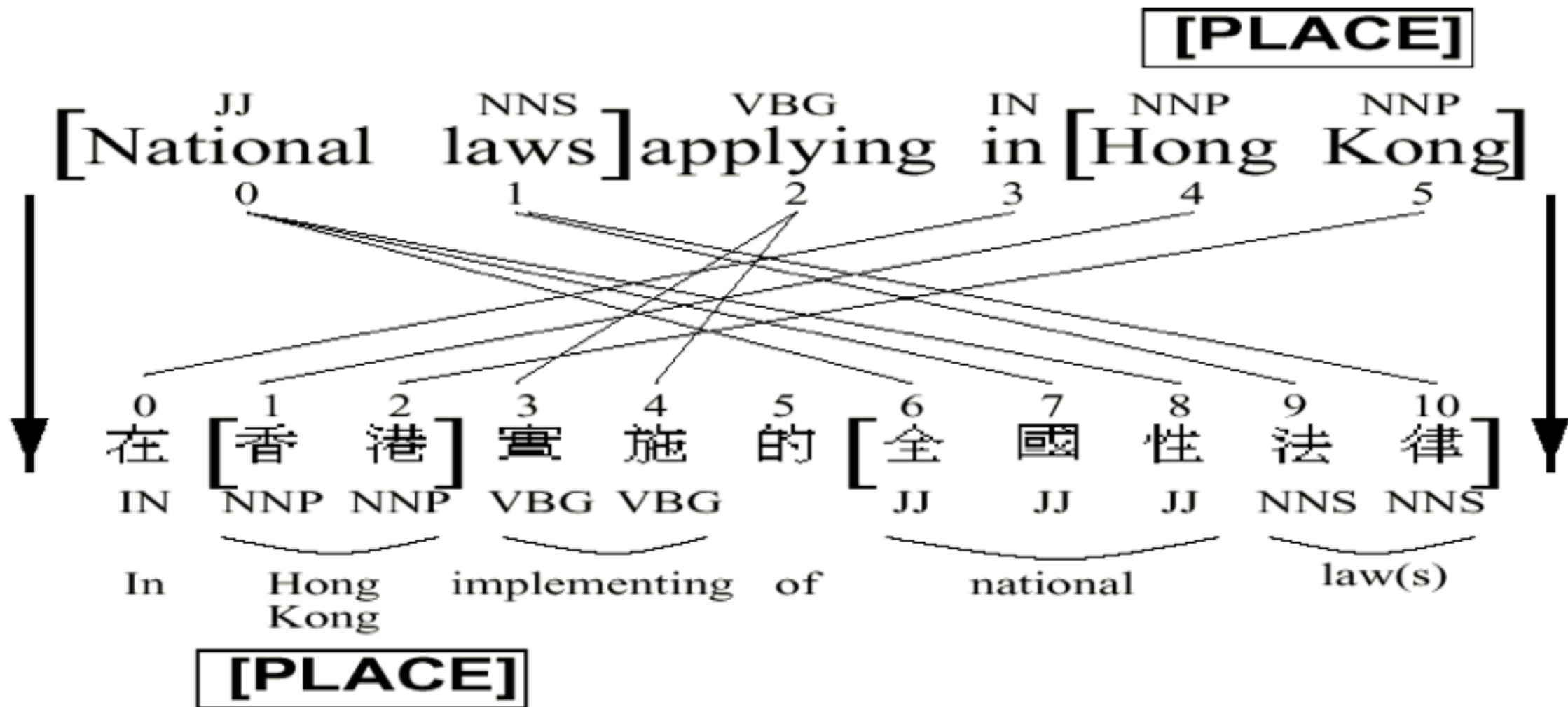

Induced Annotations for Chinese

NLP Tasks

- Analog to digital
 - OCR, Speech Recognition
- Individual language modules
 - Morphology, Syntax, Semantics, and Discourse
- Language to data
 - Information extraction and retrieval
- Language to language
 - Translation, summarization, dialogue systems

Monolingual & Multilingual

- Analysis technologies for languages
 - Morphology, syntax, semantics
- Translation technologies
 - Dictionaries, cross-lingual IR, MT
- Multilingual exploratory data analysis
 - Clustering, classification → model building

A Few Problems

Morphological Ambiguity

There are many kinds of trench mortars.

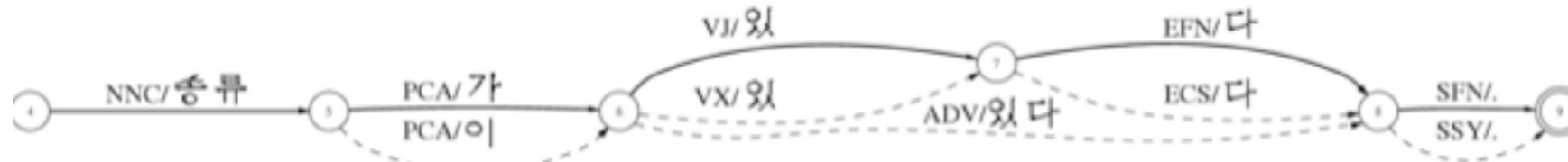

c. Klimatizovaná jídelna, světlá místnost pro snídani.

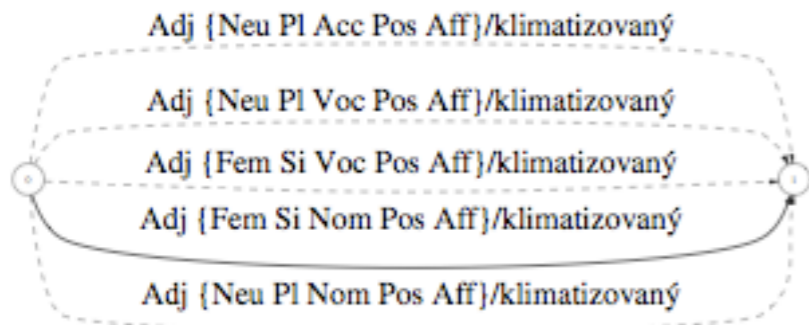

Noun {Fem Si Nom Aff}/jídelna

Punc/,

Air-conditioned dining room,

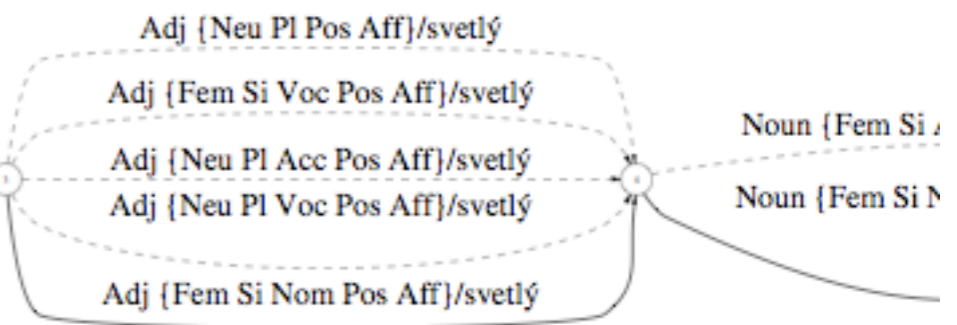

Syntactic Ambiguity

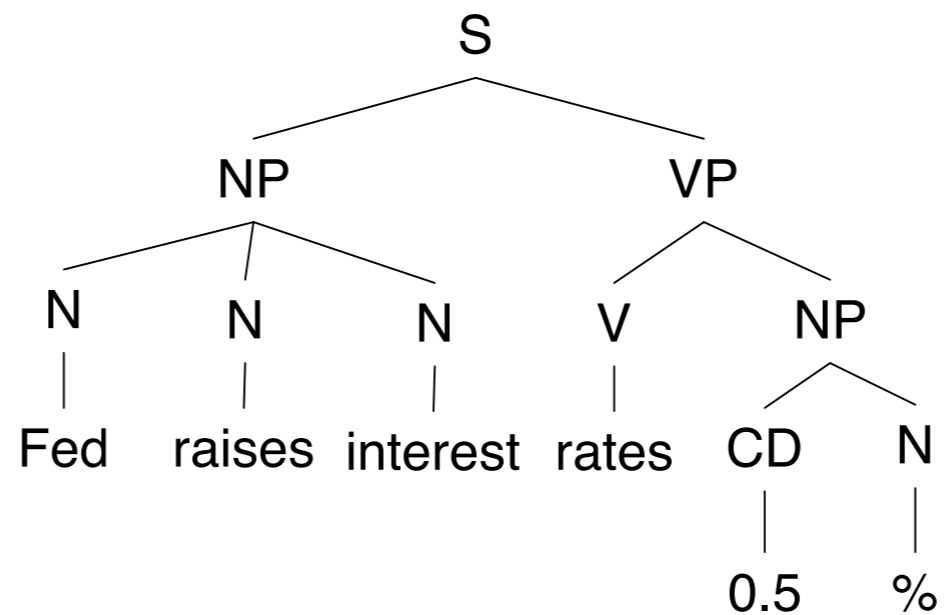
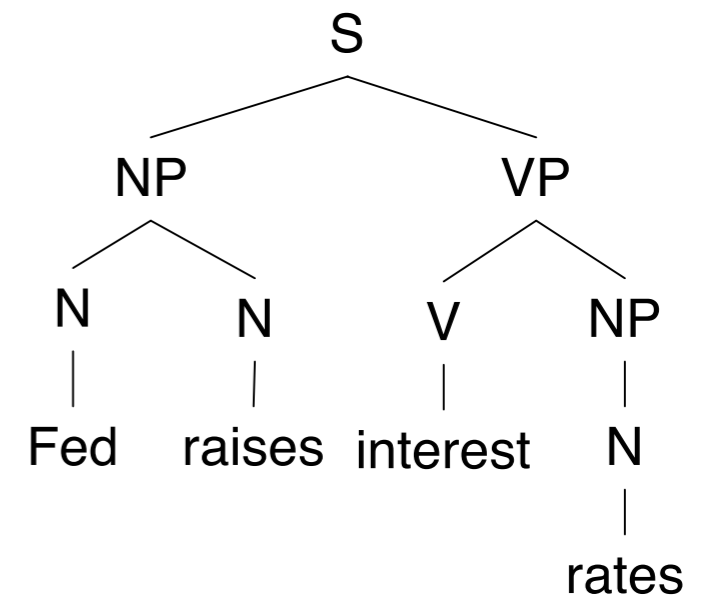
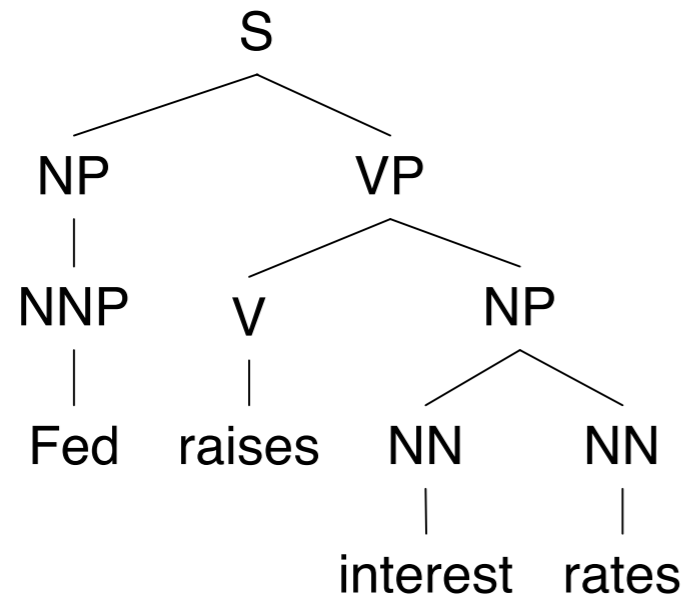

More Ambiguity

- Iraqi Head Seeks Arms
- Juvenile Court to Try Shooting Defendant
- Teacher Strikes Idle Kids
- Stolen Painting Found by Tree
- Kids Make Nutritious Snacks
- Local HS Dropouts Cut in Half
- British Left Waffles on Falkland Islands
- Red Tape Holds Up New Bridges
- Clinton Wins on Budget, but More Lies Ahead
- Ban on Nude Dancing on Governor's Desk

Why is NLP Hard?

- The rules are ambiguous
- We don't know the rules
- We need to combine lots of weak evidence
- It's *AI complete*
- Language is nearly co-extensive with humanity
- To the rescue: probability, machine learning

Why is NLP in CS?

- How about...
 - Linguistics
 - Statistics
 - Psychology and Cognitive Science
 - The Lang/Lit Humanities
- All of the above!
 - Focus on algorithms, data analysis, engineering

What You'll Learn in NLP

- Looking at data
 - Phenomena and problems
- Modeling data
 - Linguistic and statistical tools
- Algorithms and implementation
 - Efficient computation, practical systems

No Really, What'll I Learn?

- Models of language
 - n-grams, grammars, generative, discriminative
- Algorithms to tame complexity
 - Finite-state models and regular expressions
 - Context-free grammars and parsers
- Problem solving: classification, structured prediction, generation

Who – Where – When

- Instructor: David Smith
 - dasmith@ccs.neu.edu
 - WVH 356, W 3-5 or by appointment
- TA: Maryam Aziz
 - azizm@ccs.neu.edu
 - WVH 472, TBA
- Wednesdays 6-9, Hayden 424
- www.ccs.neu.edu/course/6120sp16

What

- Upper undergrad & grad course in NLP
 - Learning to *read papers* in NLP
- Discussion and participation (20%)
- Homework assignments (4 for 30%)
- Literature review (50%)
 - Synthesis of a research area covered by 5 or 10 papers
 - Implementation/**replication** of a paper

More on Grading

- All code and written words must be your own
- **OK:** Discussing problems with others, as long as you acknowledge it
- **Not OK:** Copying other text or homework divide-and-conquer

What

- Lectures introduce algorithms, models, learning methods
- Background reading in two books:
 - *Speech and Language Processing*. Jurafsky & Martin
 - *Linguistic Structure Prediction*. Noah Smith (no relation, but sometime coauthor)

Thanks